

COS 217: Introduction to Programming Systems

Structures,
Command Line Arguments,
Dynamic Memory



PRINCETON UNIVERSITY



C STRUCTURES



{new state, updated line number} would've worked

- Java classes can have many fields



- How to get the equivalent in C?



Add some structure to your program

```
struct S {  
    long l;  
    int i;  
};  
  
struct S s = {2L, 1};  
  
s.l = s.i;
```

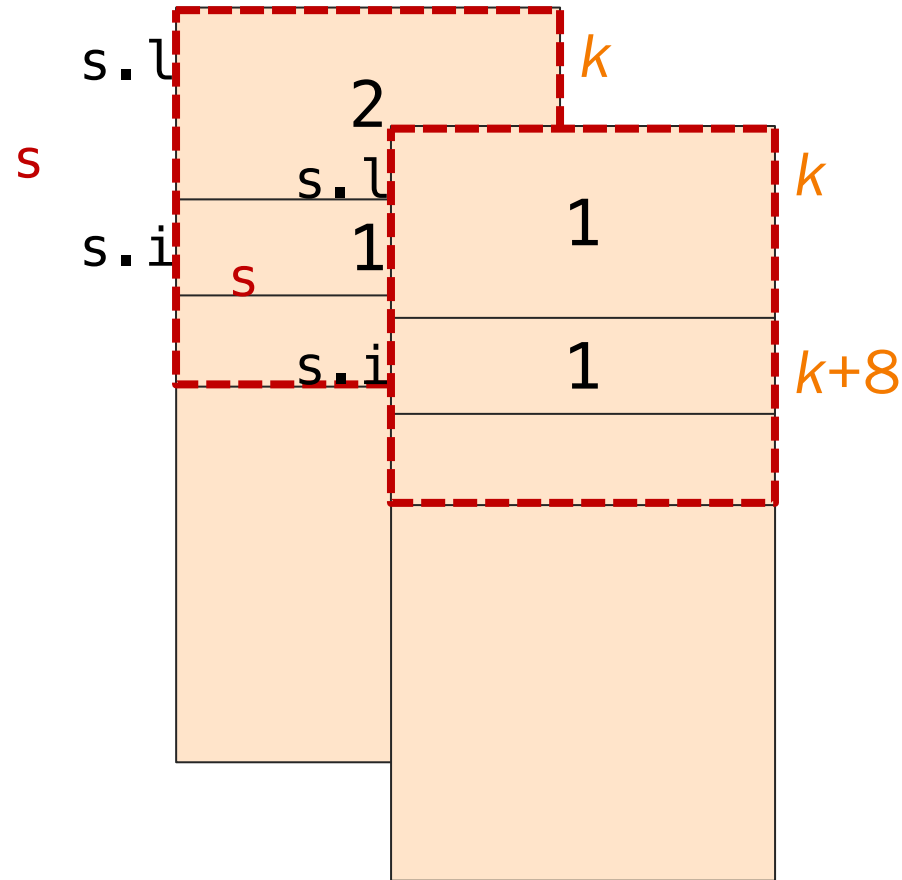



Add some structure to your program

```
struct S {  
    long l;  
    int i;  
};  
  
struct S s = {2L, 1};  
struct S *ps = &s;  
  
s.l = s.i;  
(*ps).i *= 2;
```

This is such a common pattern
that it has its own operator:

$ps \rightarrow i$

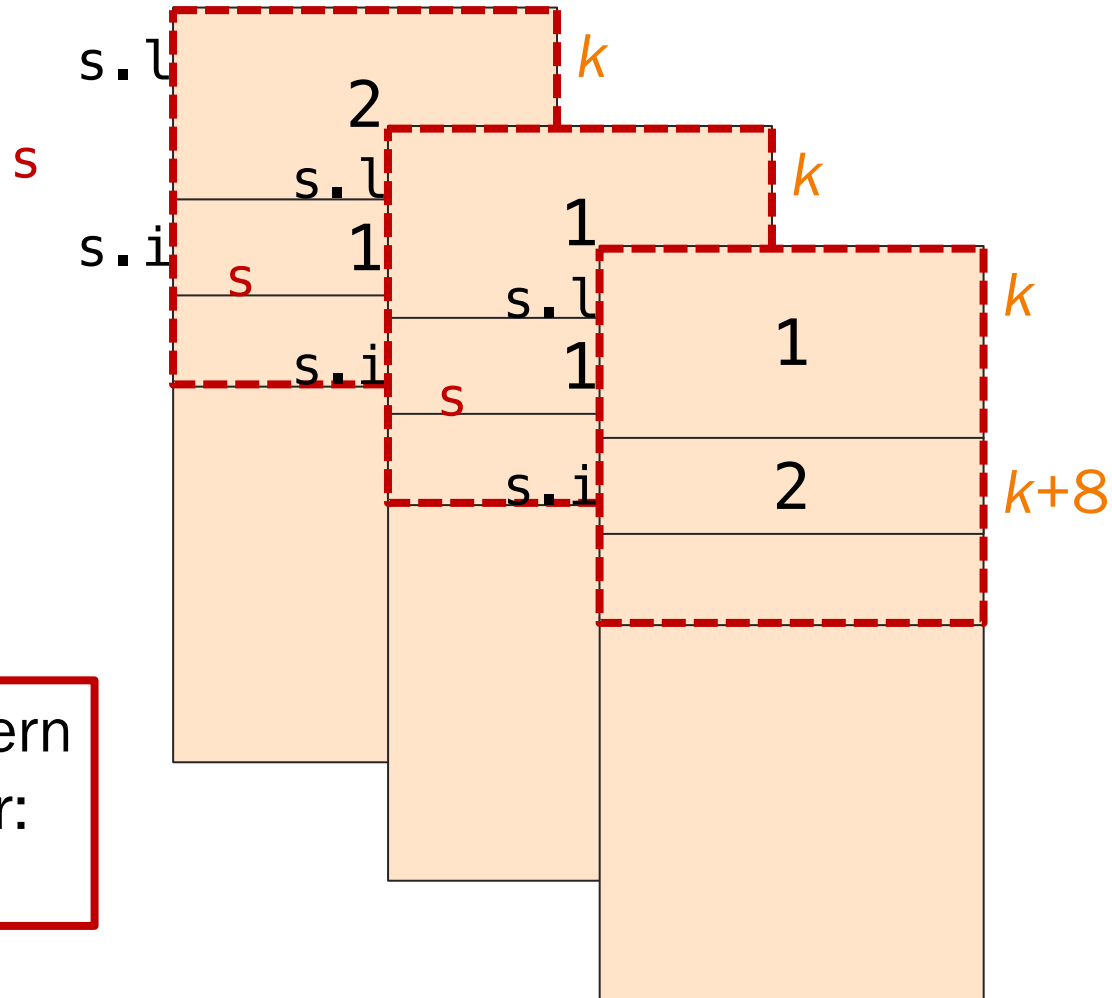



struct instruction

```
struct S {  
    long l;  
    int i;  
};  
  
struct S s = {2L, 1};
```

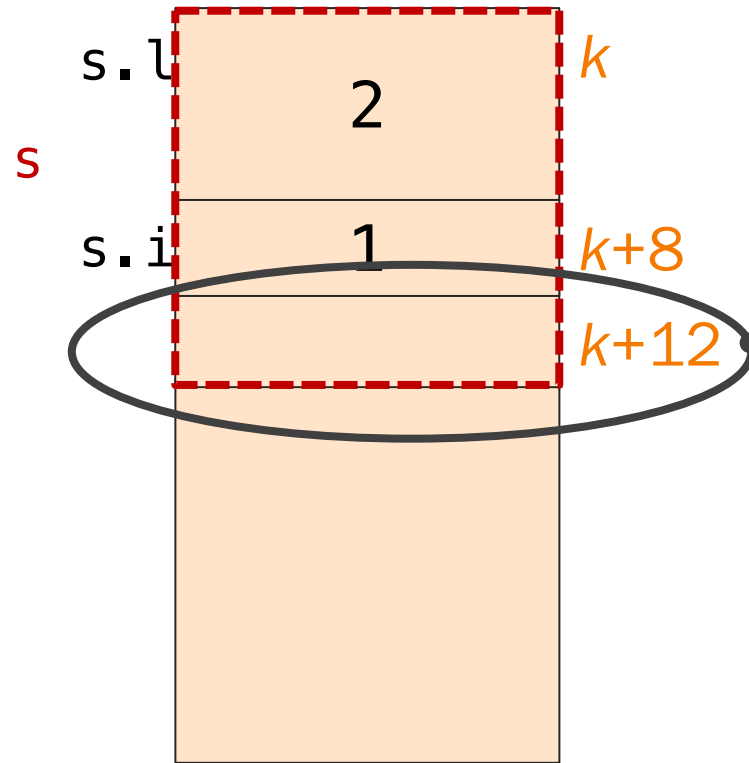



Internal Padding

```
struct S {  
    int i;  
    long l;  
};  
  
struct S s = {1, 2L};
```

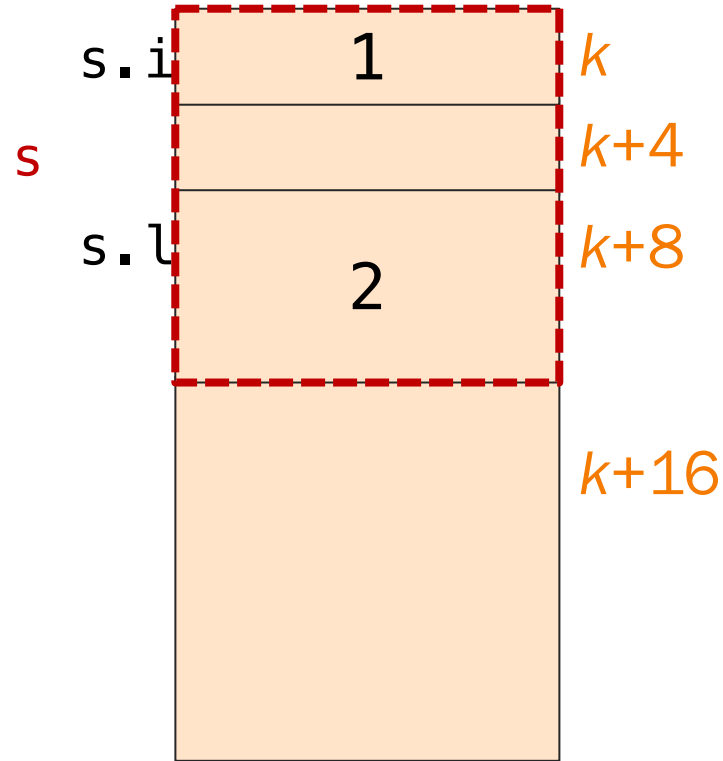



structstructstructstructstructstruct

```
struct S {
  int i;
  long l;
};
```

```
struct S as[2] =
  { {1, 2L}, {3, 4L} };
```

```
as[1] = as[0];
```

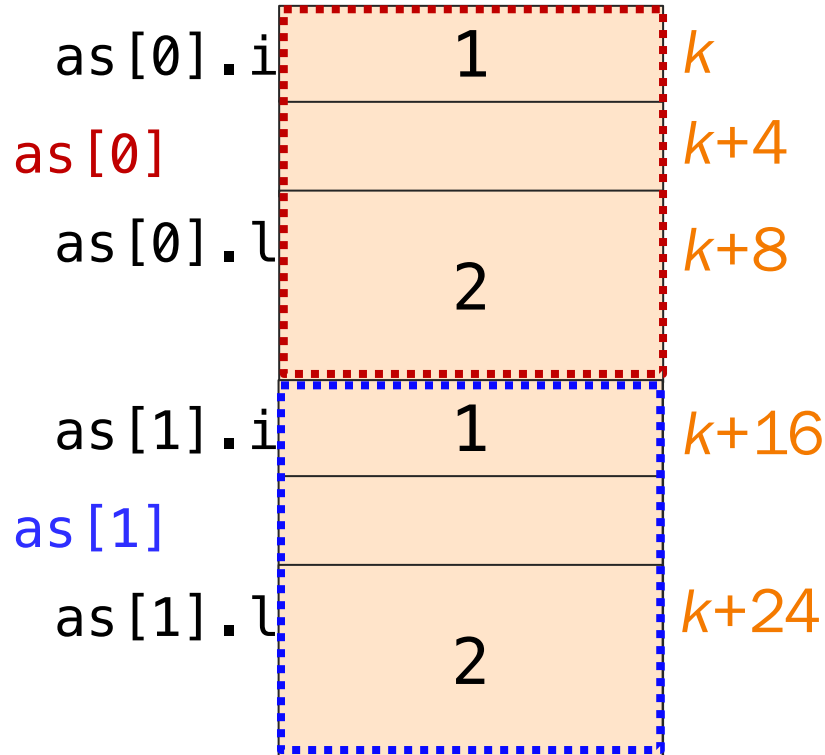



struct construction, what's your function?

```
void printS(struct S s) {
    printf("%d %ld\n", s.i, s.l);
}
void swap1(struct S s) {
    int iTemp = s.l;
    s.l = s.i;
    s.i = iTemp;
}
struct S swap2(struct S s) {
    int iTemp = s.l;
    s.l = s.i;
    s.i = iTemp;
    return s;
}
void swap3(struct S *ps) {
    int iTemp = ps->l;
    ps->l = ps->i;
    ps->i = iTemp;
}
```

```
int main(void) {
    struct S s = {1, 2L};
    printS(s);

    swap1(s);
    printS(s);

    s = swap2(s);
    printS(s);

    swap3(&s);
    printS(s);
    return 0;
}
armlab01:~/Test$ ./sswap
1 2
1 2
2 1
1 2
```



Whose Rules Rule?



```
struct S {
    int aiSomeInts[10];
};

void printS(struct S s) {
    int i;
    for (i = 0; i < 10; i++)
        printf("%d ", s.aiSomeInts[i]);
    printf("\n");
}
```

How many int arrays are stored in memory?

- A. 0: arrays in a struct aren't really arrays
- B. 1: arrays are copied/passed as a pointer
- C. 2: structs are copied on assignment
- D. 3: C, plus structs are passed by value
- E. Arrays can't be fields of a structure.

```
int main(void) {
    struct S s = { {0,1,2,3,4,5} };
    struct S s2 = s;
    printS(s2);
    return 0;
}
```

```
armlab01:~/Test$ ./sa
0 1 2 3 4 5 0 0 0 0
```

The correct answer is **D**.

Passing, returning, or assigning a structure with an array field copies the array by value (a deep copy)!



COMMAND LINE ARGUMENTS



What's my name?

- String[] args was COS 126 day 1



- How to get the equivalent in C?



With sed s/s/v/ , natch.

```
int main(int argc, char *argv[])  
{  
    int i;  
  
    /* Write the command-line argument count to stdout. */  
    printf("argc:  %d\n", argc);  
  
    /* Write the command-line arguments to stdout. */  
    for (i = 0; i < argc; i++)  
        printf("argv[%d]:  %s\n", i, argv[i]);  
  
    return 0;  
}
```

As parameters, these are identical:
char a[] and char *a
So it follows that, as parameters, these are, too:
char *argv[] and char **argv



Elucidating Example: Explanatory echo

```
int main(int argc, char *argv[])  
{  
    int i;  
    printf("argc:  %d\n", argc);  
  
    for (i = 0; i < argc; i++)  
        printf("argv[%d]:  %s\n", i,  
              argv[i]);  
  
    return 0;  
}
```

\$./printargv one two three

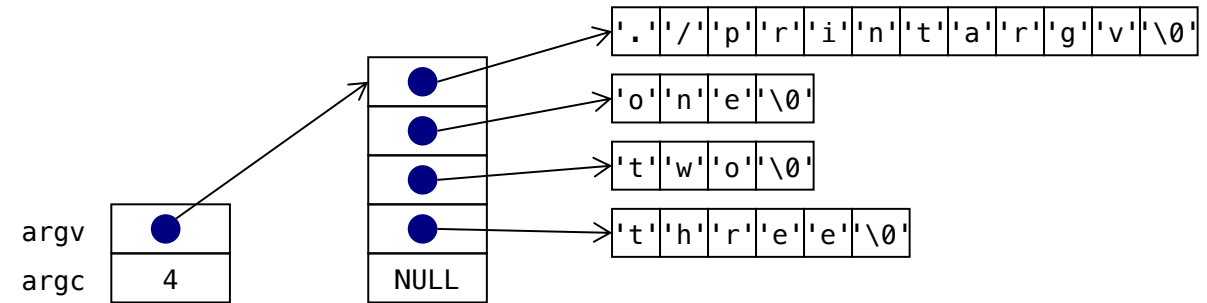

\$./printargv

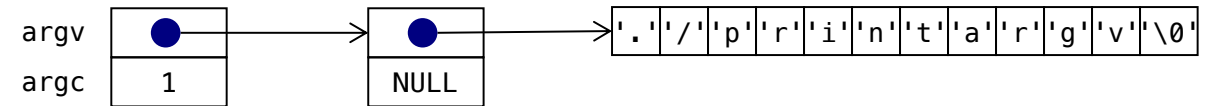



What's argc?



```
./printargv one "two three" four
```

B:

```
$ ./printargv one "two three" four
```

A. 3

B. 4

C. 5

D. Syntax error at runtime

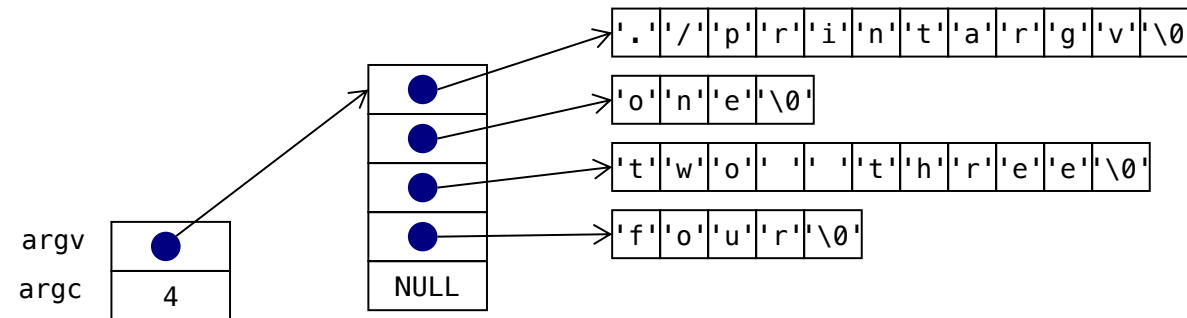



A2-inspired: rewrite everything in arrays to use pointers

\$./printargv one two three

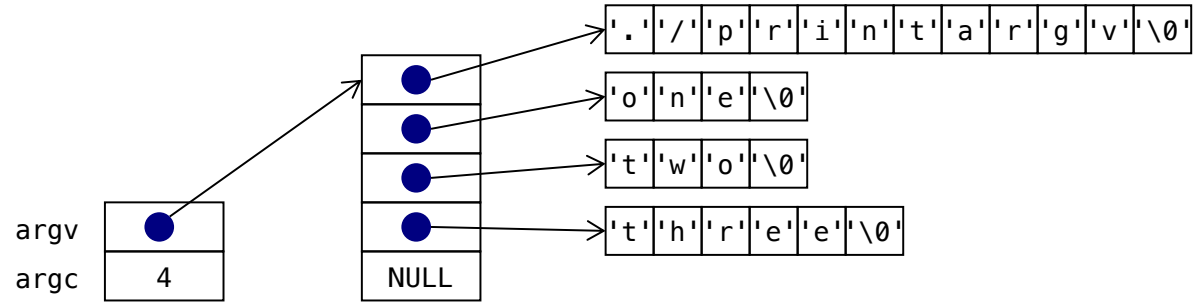

```
int main(int argc, char *argv[])
{
    char **ppc = argv;
    printf("argc:  %d\n", argc);

    while (*ppc != NULL)
        printf("argv[%d]:  %s\n",
              ppc-argv, *ppc++);
    return 0;
}
```

\$./printargv

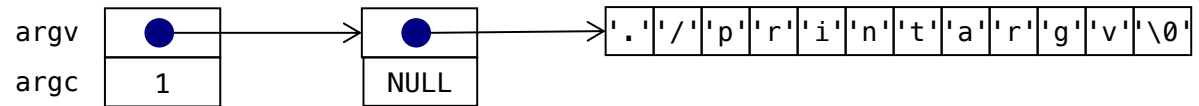

Post-increment with pointers is just like we saw with integer types: emits the old value of ppc

The dereference then happens on value emitted, so this could be parenthesized as: `*(ppc++)`



Kicking the extra point?



```
int main(int argc, char *argv[])
{
    char **ppc = argv;
    int i = 0;
    printf("argc:  %d\n", argc);

    while(*ppc != NULL)
        printf("argv[%d]:  %s\n", i++,
              *ppc++);

    return 0;
}
```



```
int main(int argc, char *argv[])
{
    char *pc = *argv;
    int i = 0;
    printf("argc:  %d\n", argc);

    while(pc != NULL)
        printf("argv[%d]:  %s\n", i++,
              pc++);

    return 0;
}
```

- A. Yes! This works and is clearer.
- B. Maybe. This works but is less clear.
- C. No! This is incorrect!
- D. No! This doesn't even compile!

C: When run with no arguments:

```
argc: 1
argv[0]: ./pcla-wrong
argv[1]: /pcla-wrong
argv[2]: pca-wrong
argv[3]: cla-wrong
...
```



Challenge for the bored: mainly nonsense



```
int main(int argc, char **argv) {
    int retVal;
    if (argc == 0) {
        return 0;
    } else {
        retVal = main(argc-1, argv+1);
        printf("%d: %s\t", argc-1, argv[0]);
        return retVal;
    }
}
```

What does this program do?

- A. prints arguments
- B. prints arguments in reverse order
- C. recurs infinitely: argc is always ≥ 1
- D. prints only the last argument:
return from main exits the program

The correct answer is B:

```
armlab01:~/Test$ ./recur-r a b c; echo
0: c 1: b 2: a 3: ./recur-r
```

C is only the case at the start of execution,
and does not hold if the program changes argc.

D would be the behavior with `exit(retVal)`; instead of `return retVal`;

@jorgetung



DYNAMIC MEMORY



Why, though?

- Thus far, all memory that we have used has had to be known at compile time.
- This is not feasible for realistic workloads; many times memory needs are dependent on runtime state
 - User input
 - Reading from a resource (file, network, etc.)
 - ...

```
How many records are being entered?
```





Memory Allocation at Runtime

Thus far we have seen 3 memory sections:

Stack

- Activation records (aka "stackframes"): a function call's params and local variables

Text

- Program machine language code

RODATA

- Read-only data, e.g. string literals



Now, a 4th: the "Heap"



Your New Friends: malloc

```
int iCount;  
int *piSomeInts;  
printf("How many ints?");  
scanf("%d", &iCount);  
piSomeInts =  
    malloc(iCount *  
           sizeof(int));
```

```
int iCount;  
int *piSomeInts;  
printf("How many ints?");  
scanf("%d", &iCount);  
piSomeInts =  
    calloc(iCount,  
           sizeof(int));
```

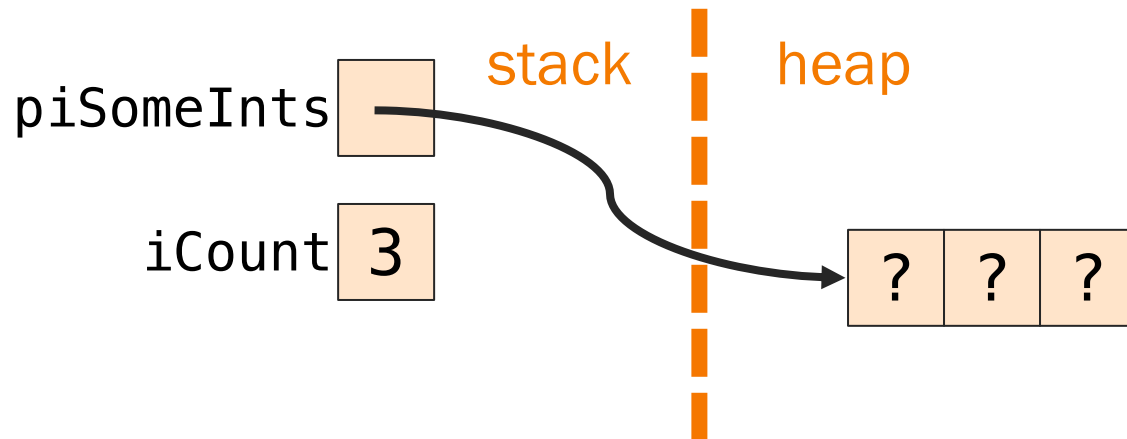



Your New Friends: calloc

```
int iCount;
int *piSomeInts;
printf("How many ints?");
scanf("%d", &iCount);
piSomeInts =
    malloc(iCount *
           sizeof(int));
```

```
int iCount;
int *piSomeInts;
printf("How many ints?");
scanf("%d", &iCount);
piSomeInts =
    calloc(iCount,
           sizeof(int));
```

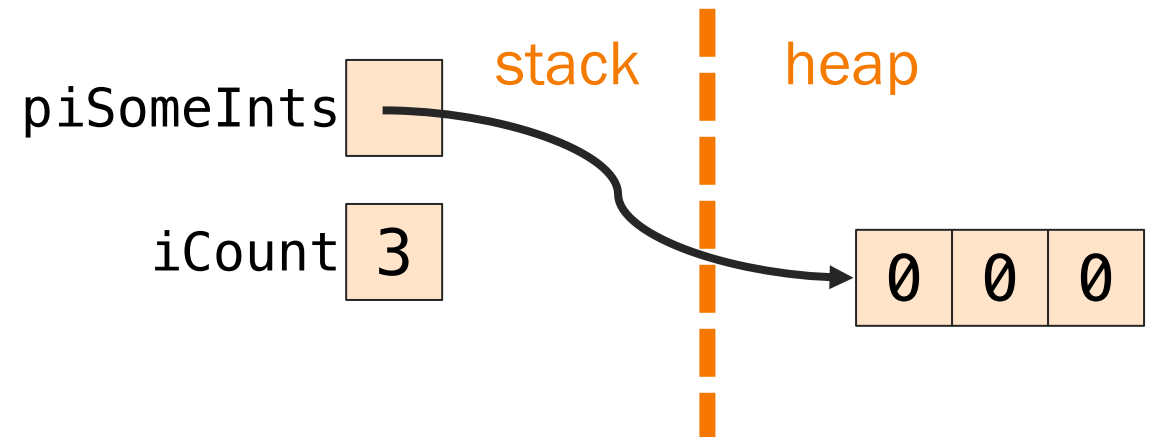



Your New Friends: free

```
int iCount;  
int *piSomeInts;  
printf("How many ints?");  
scanf("%d", &iCount);  
piSomeInts = calloc(iCount, sizeof(int));  
  
free(piSomeInts);
```

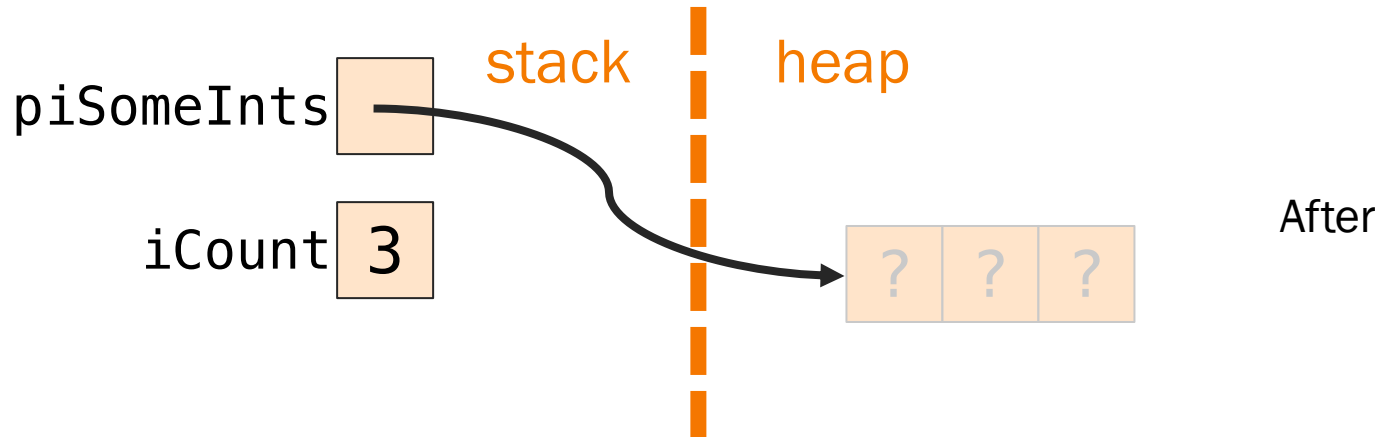
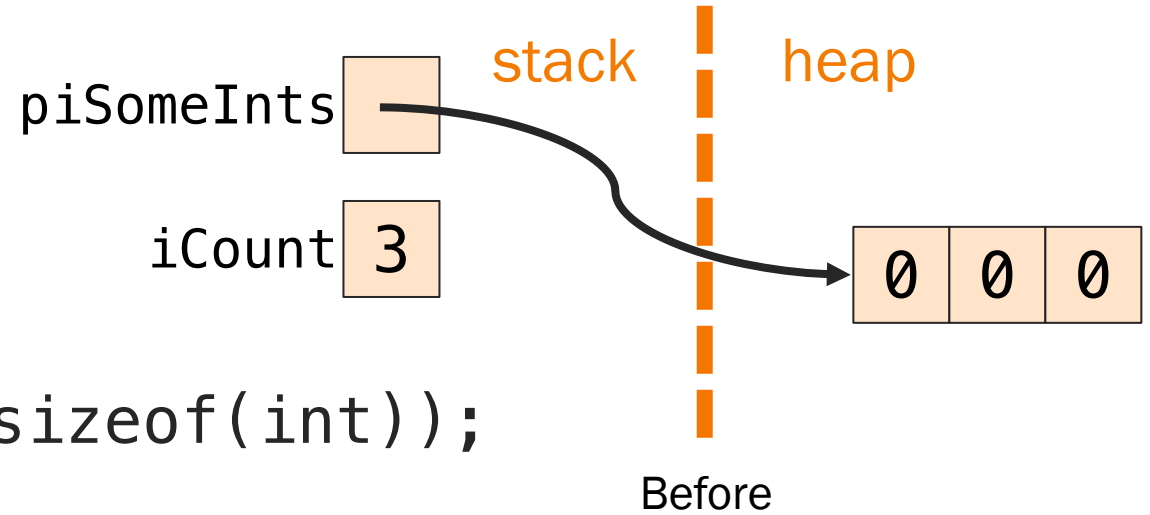



Your New Friends: realloc

```
int iCount;  
int *piSomeInts, *piMoreInts;  
printf("How many ints?");  
scanf("%d", &iCount);  
piSomeInts = calloc(iCount, sizeof(int));
```

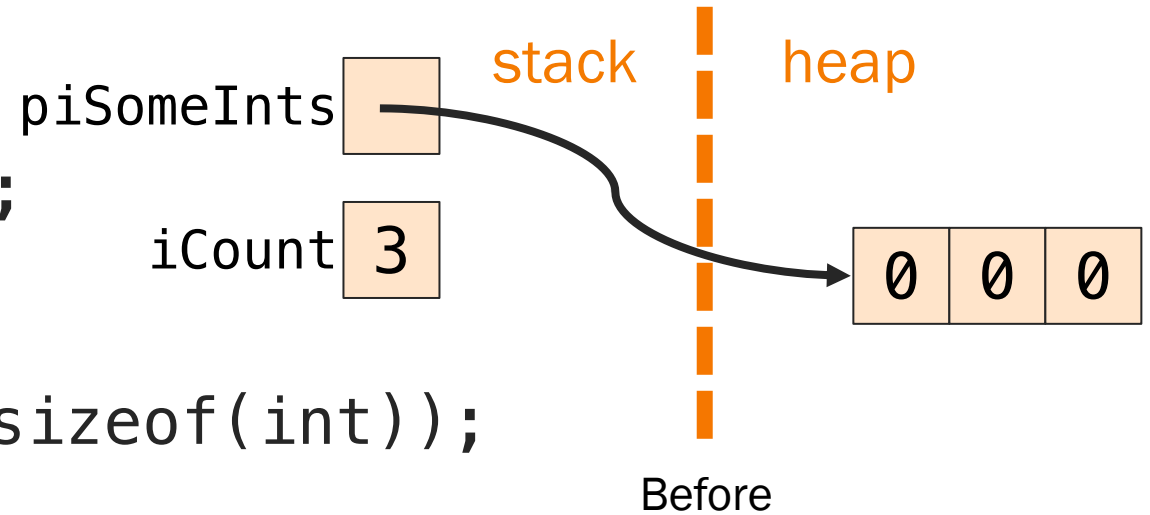

```
piMoreInts = realloc(piSomeInts, (iCount-1)*sizeof(int));
```

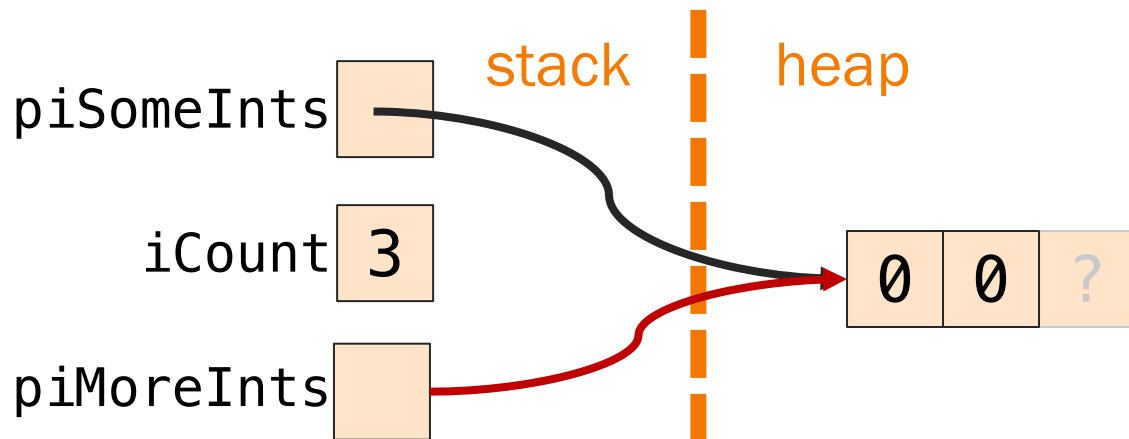

After
(typically, and definitely on armlab,
but not guaranteed by the C
standard)



Your New Friends: realloc

```
int iCount;  
int *piSomeInts, *piMoreInts;  
printf("How many ints?");  
scanf("%d", &iCount);  
piSomeInts = calloc(iCount, sizeof(int));
```

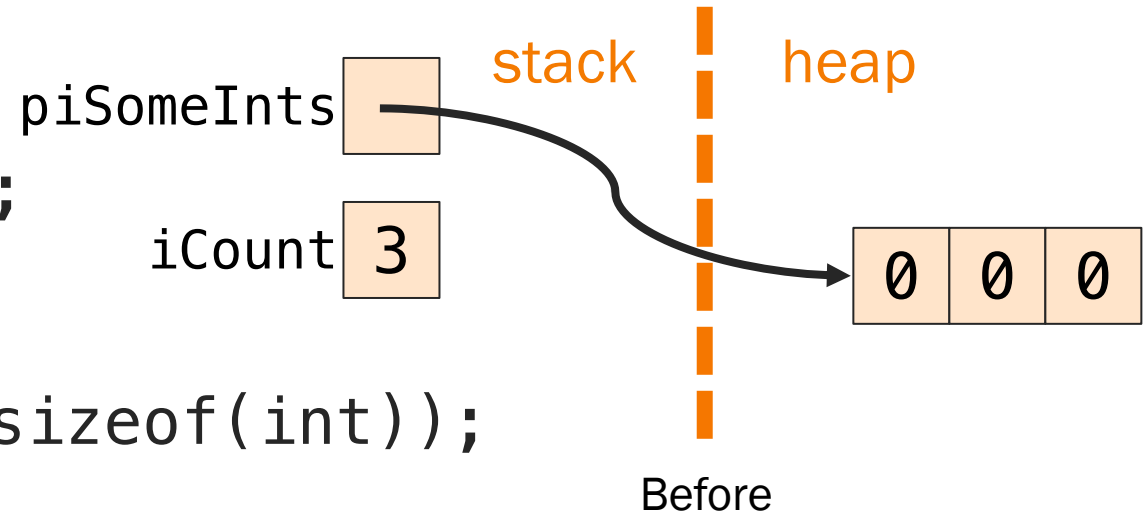

```
piMoreInts = realloc(piSomeInts, (iCount+1)*sizeof(int));
```

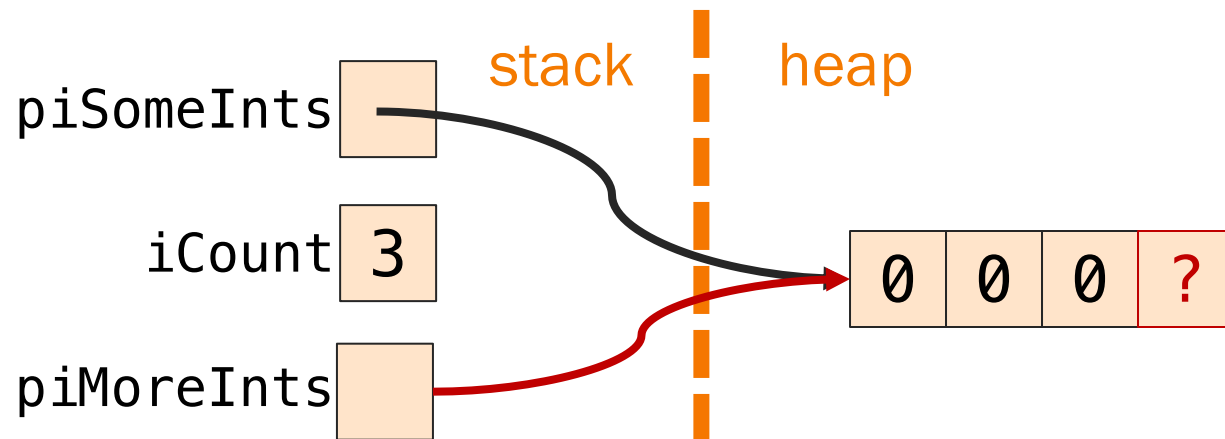

After
(typically, but not guaranteed,
especially if instead of $(iCount+1)$
you want, say, 2^{iCount})



Your New Friends: realloc

```
int iCount;  
int *piSomeInts, *piMoreInts;  
printf("How many ints?");  
scanf("%d", &iCount);  
piSomeInts = calloc(iCount, sizeof(int));
```

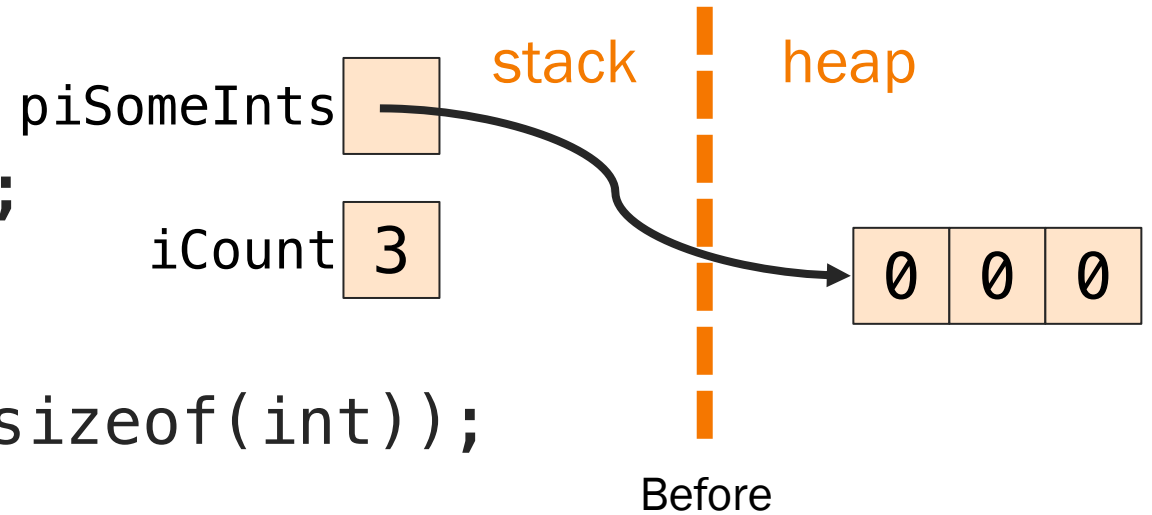

```
piMoreInts = realloc(piSomeInts, (iCount+1)*sizeof(int));
```

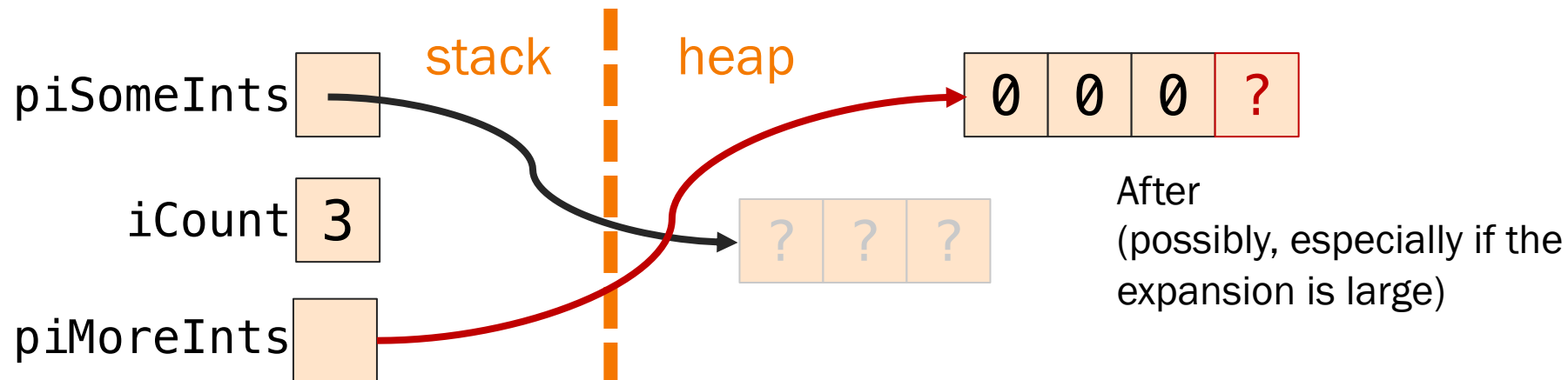



What could go wrong (malloc, calloc)?

```
int iCount;  
int *piSomeInts;  
printf("How many ints?");  
scanf("%d", &iCount);  
piSomeInts = calloc(iCount, sizeof(int));  
if(piSomeInts == NULL)...  
piSomeInts[0] = ...
```

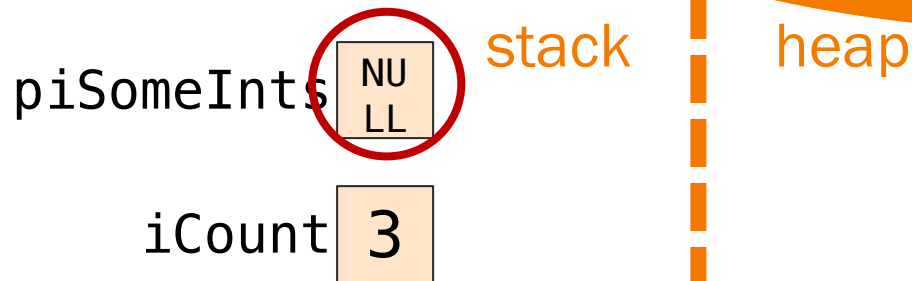



What could go wrong (free)?

```
int iCount;  
int *piSomeInts;  
printf("How many ints?");  
scanf("%d", &iCount);  
piSomeInts = calloc(iCount, sizeof(int));  
free(piSomeInts);  
piSomeInts[0] = x;  
free(piSomeInts);
```

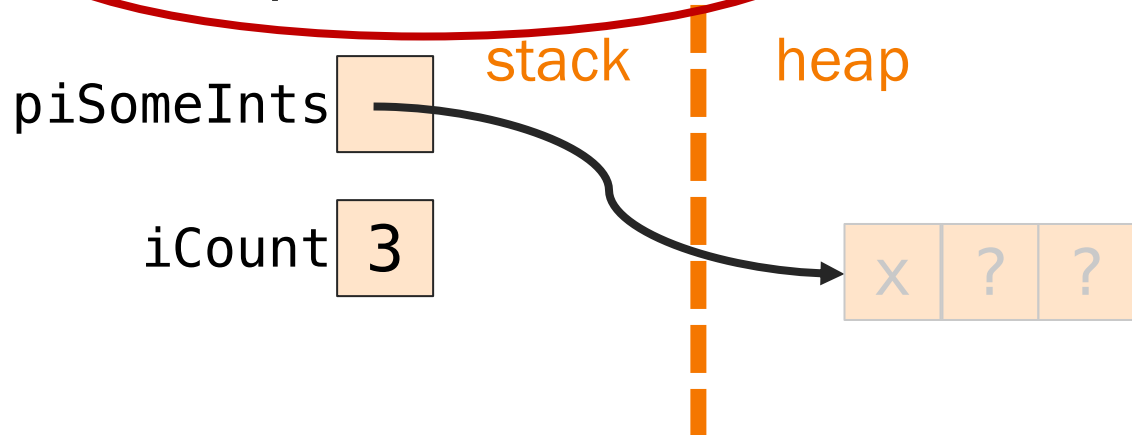



It's still a bug! (But now you'll find it "easily"!)

```
int iCount;  
int *piSomeInts;  
printf("How many ints?");  
scanf("%d", &iCount);  
piSomeInts = calloc(iCount, sizeof(int));  
free(piSomeInts); piSomeInts = NULL;  
piSomeInts[0] = x;  
free(piSomeInts);
```

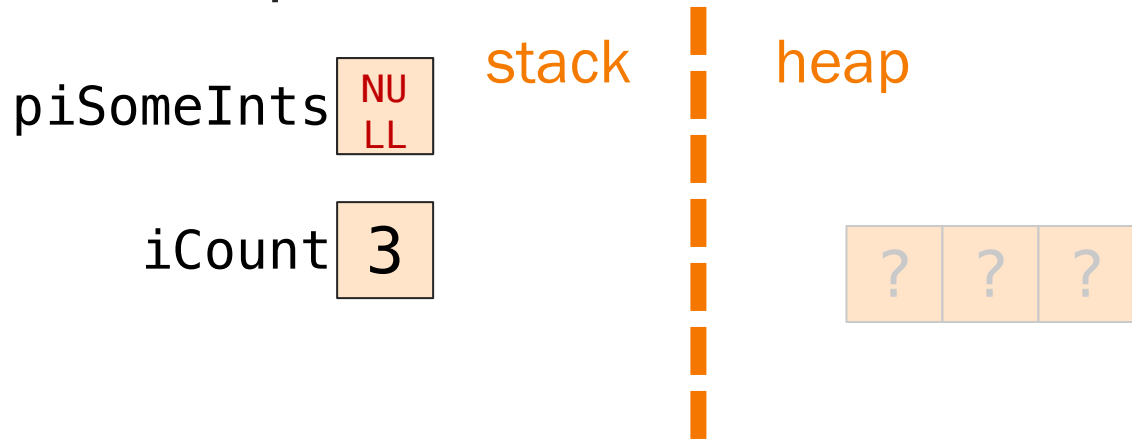



What could go wrong: realloc

```
int iCount;
int *piSomeInts, *piMoreInts;
printf("How many ints?");
scanf("%d", &iCount);
piSomeInts = calloc(iCount, sizeof(int));
piSomeInts =
    realloc(piSomeInts, (iCount+1)*sizeof(int));
if(piSomeInts == NULL)...
```

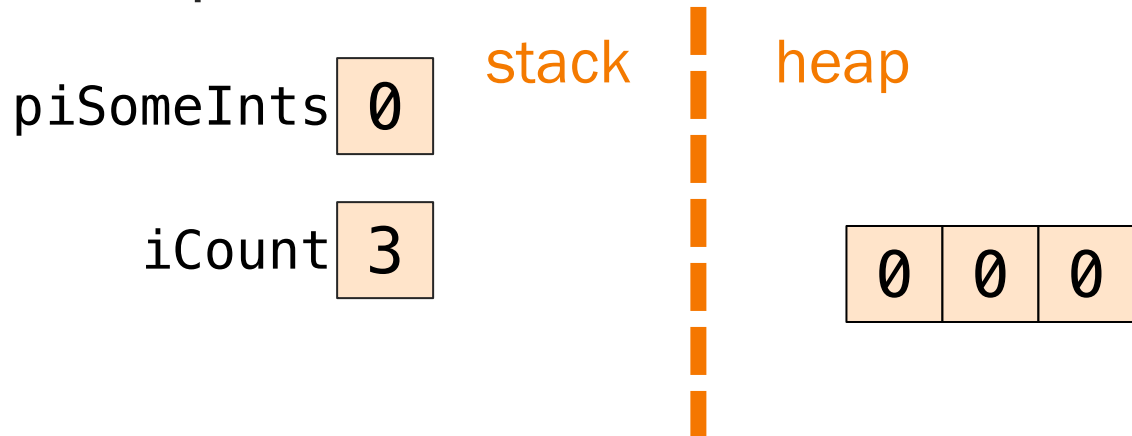
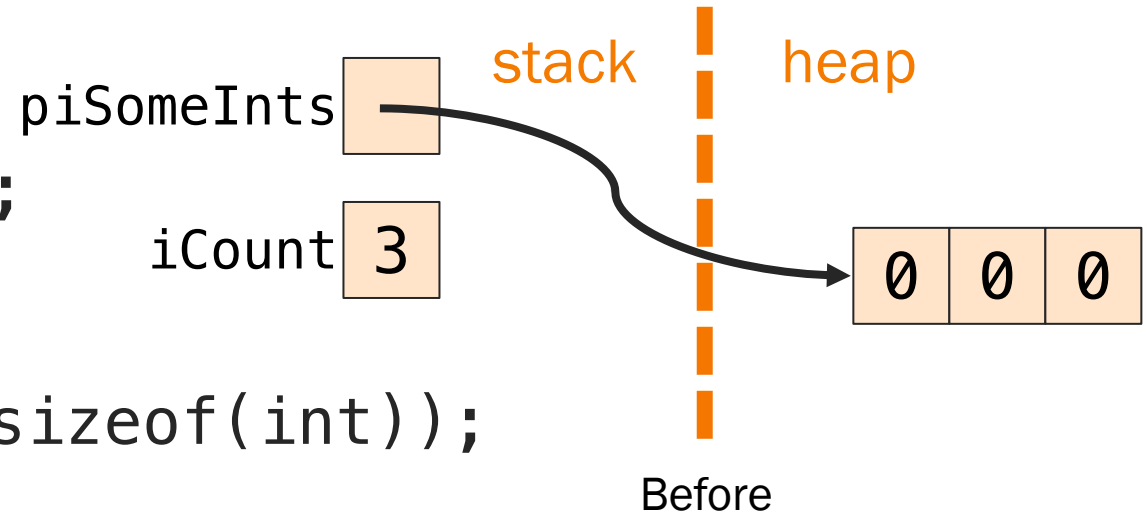

After:
If realloc returns NULL,
Memory Leak
NULL pointer dereference if not checked



What could go *really* wrong: realloc

```
int iCount;  
int *piSomeInts, *piMoreInts;  
printf("How many ints?");  
scanf("%d", &iCount);  
piSomeInts = calloc(iCount, sizeof(int));  
realloc(piSomeInts, (iCount+1)*sizeof(int));  
if(piSomeInts == NULL)...
```

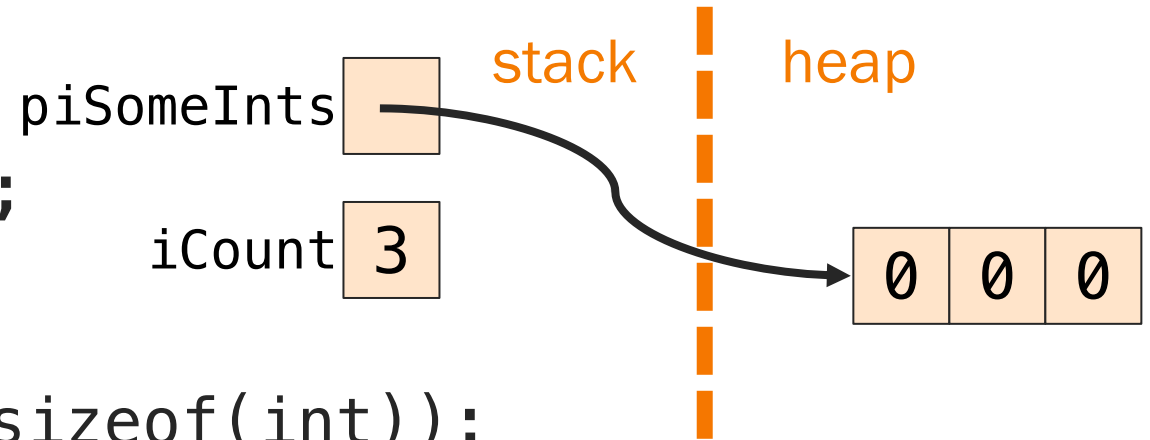

Before

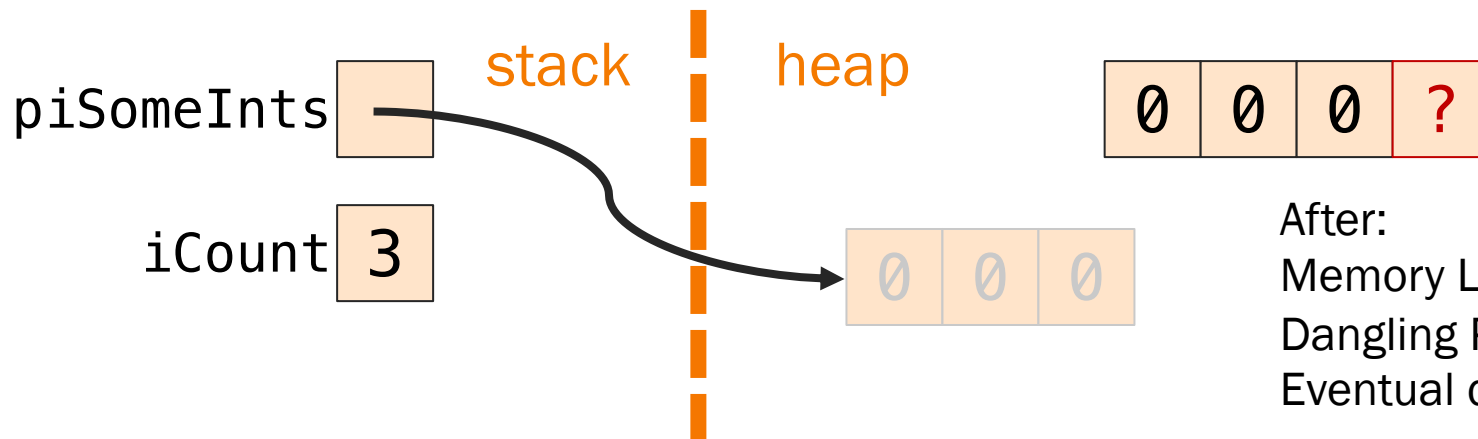

After:
Memory Leak,
Dangling Pointer,
Eventual double free.



Catch the Most Common Bug

Yes, even more common than

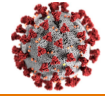

```
newCopy = malloc(strlen(oldCopy));  
strcpy(newCopy, oldCopy);
```

Does this work?

A. Totally! (Wait, what's the title of this slide again?)

B. Nope! The bug is ...

B:

This allocates **1** too few bytes for newCopy, because strlen doesn't count the trailing '\0'.



Save a line?



```
newCopy = strcpy(malloc(strlen(oldCopy)+1), oldCopy);
```

Does this work?

- A. So *that's* why `strcpy` returns the destination! Sure!
- B. Eh, okay, but this is less clear.
- C. Nope!

C:

If `malloc` returns `NULL`, this fails the precondition for `strcpy`

(This was also an issue on the previous slide.)



Don't get ahead of yourself!

Assignment 2 does **NOT** use dynamic memory!

Assignments 3 and 4 will use it extensively.
The topic is fair game for the midterm.

But **DO NOT** use `{m, c, re}alloc + free` on A2!

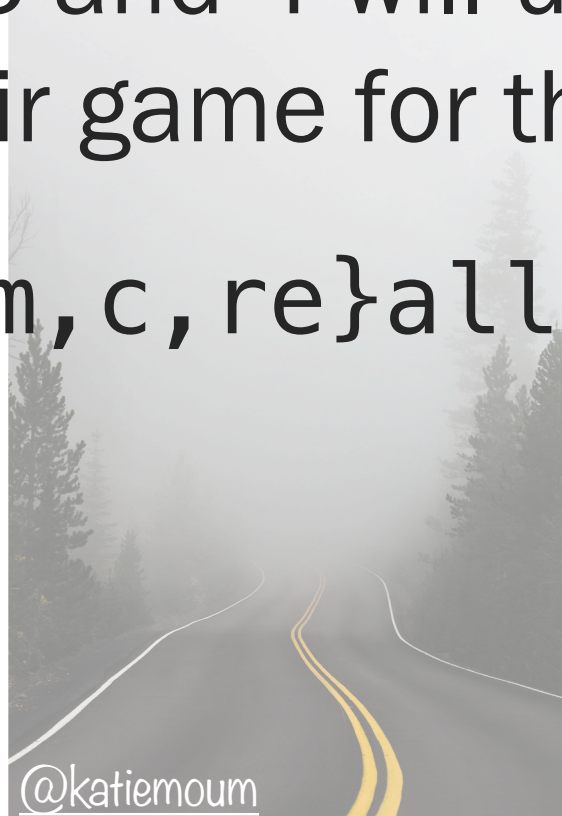

@katiemoum