

Princeton University
COS 217: Introduction to Programming Systems
Trace of teststack (Version 1)

```
int main(void)
```

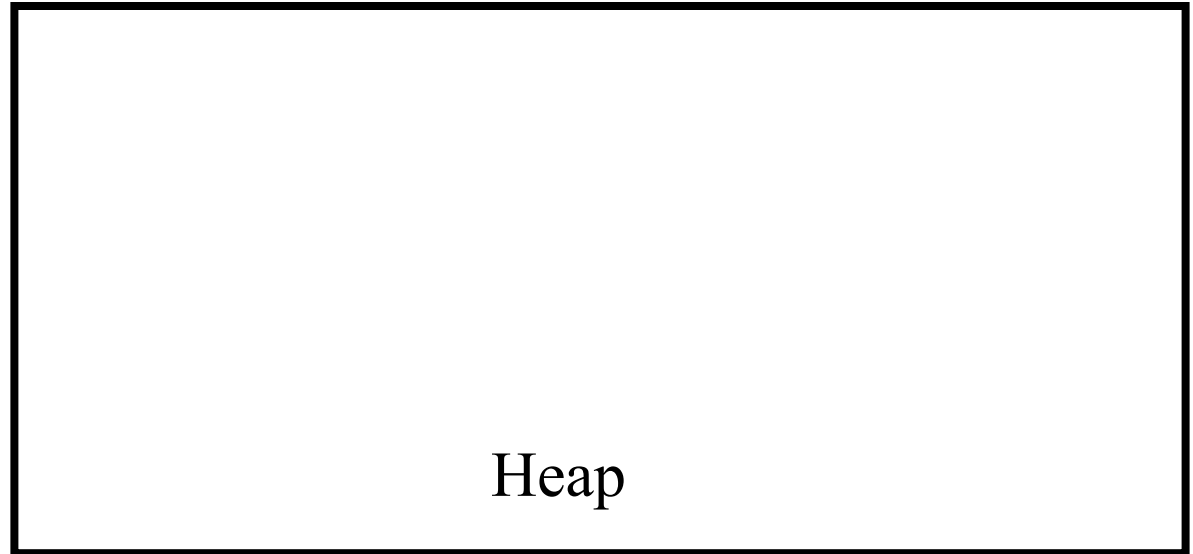
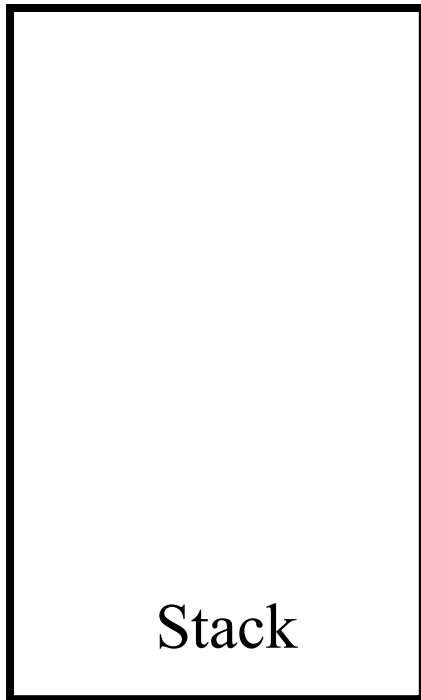

Princeton University
COS 217: Introduction to Programming Systems
Trace of teststack (Version 1)

```
struct Stack *psStack1;
```

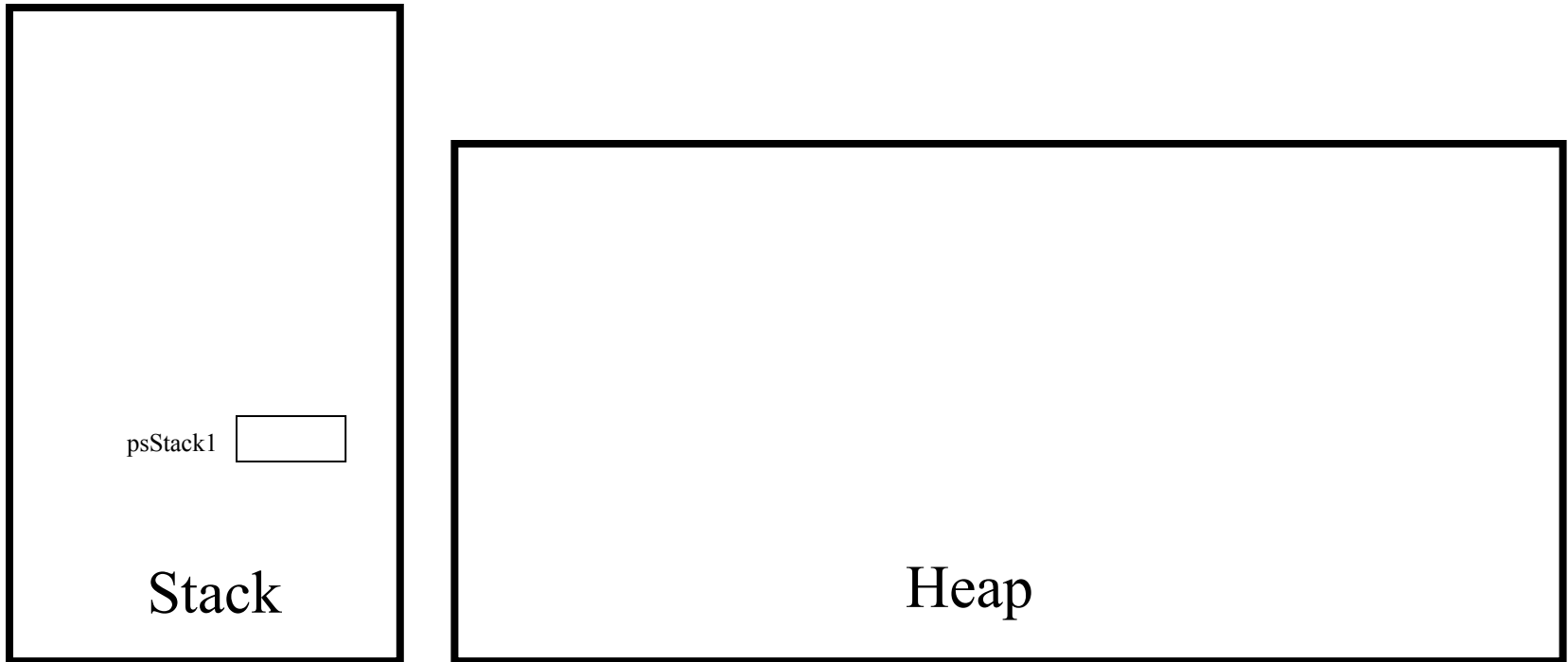

Princeton University
COS 217: Introduction to Programming Systems
Trace of teststack (Version 1)

```
struct Stack *psStack2;
```

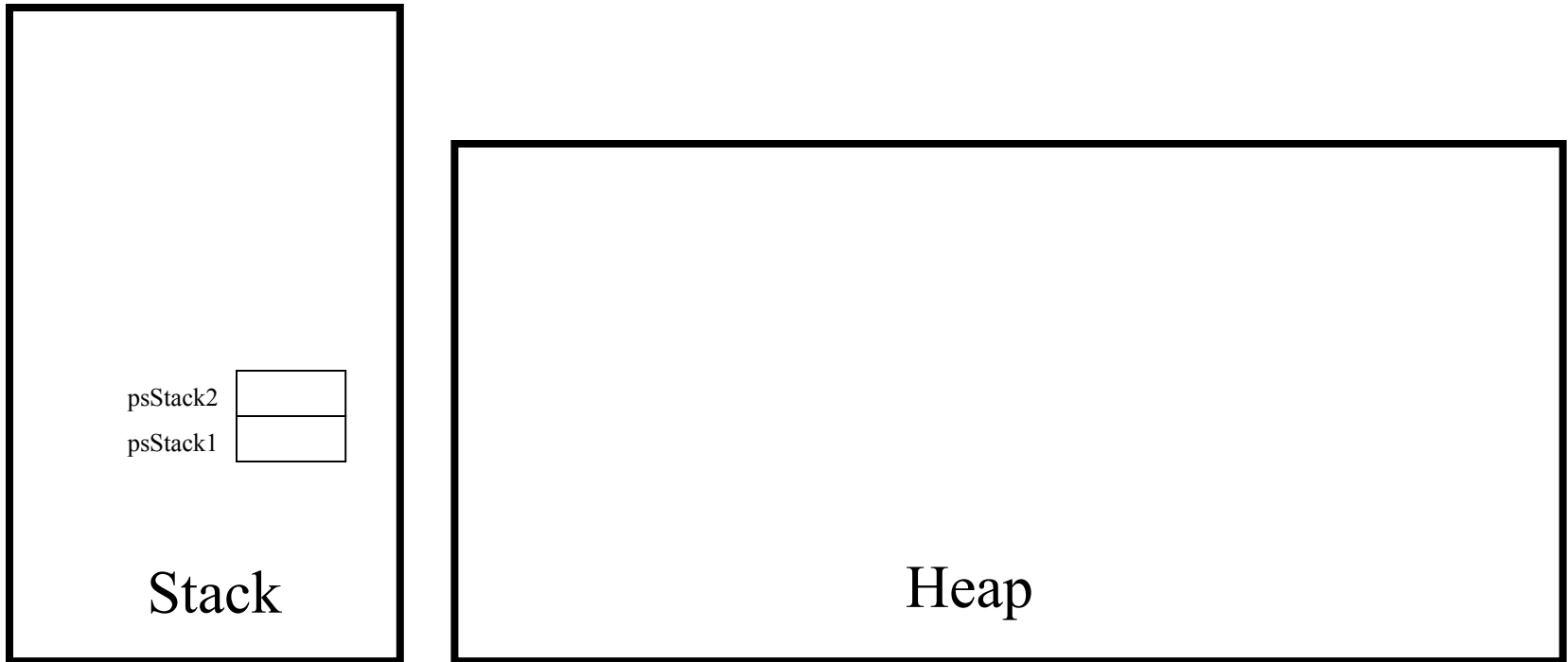

Princeton University
COS 217: Introduction to Programming Systems
Trace of teststack (Version 1)

```
int iSuccessful;
```

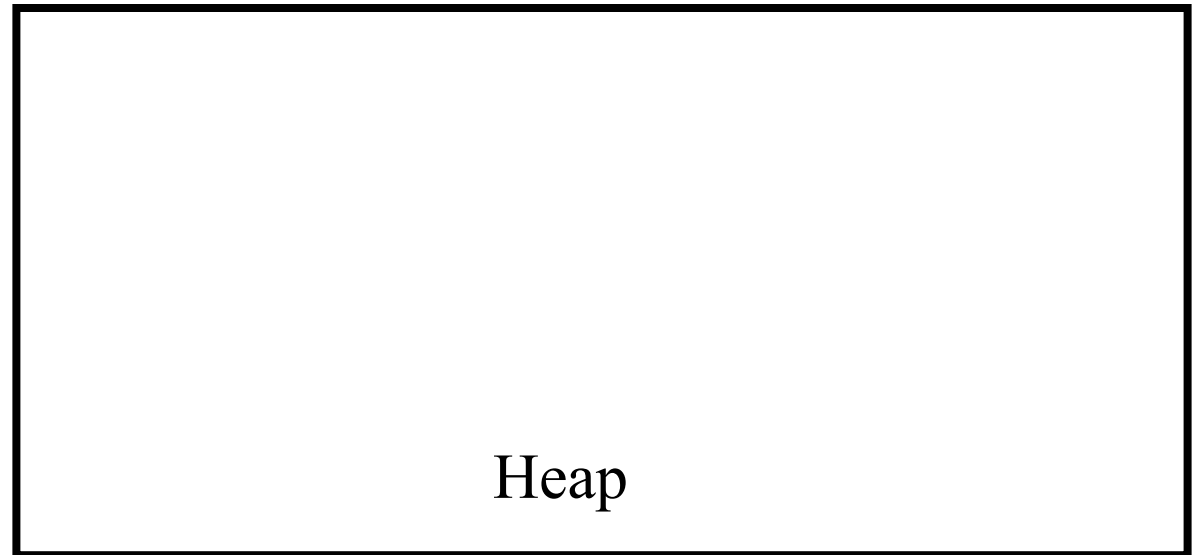
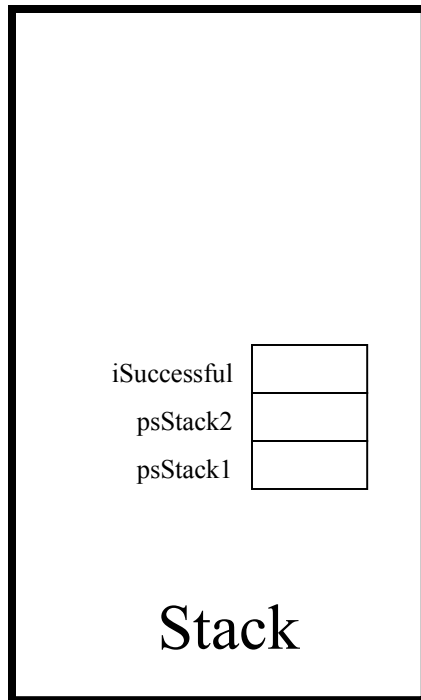

Princeton University
COS 217: Introduction to Programming Systems
Trace of teststack (Version 1)

```
psStack1 = Stack_new();
```

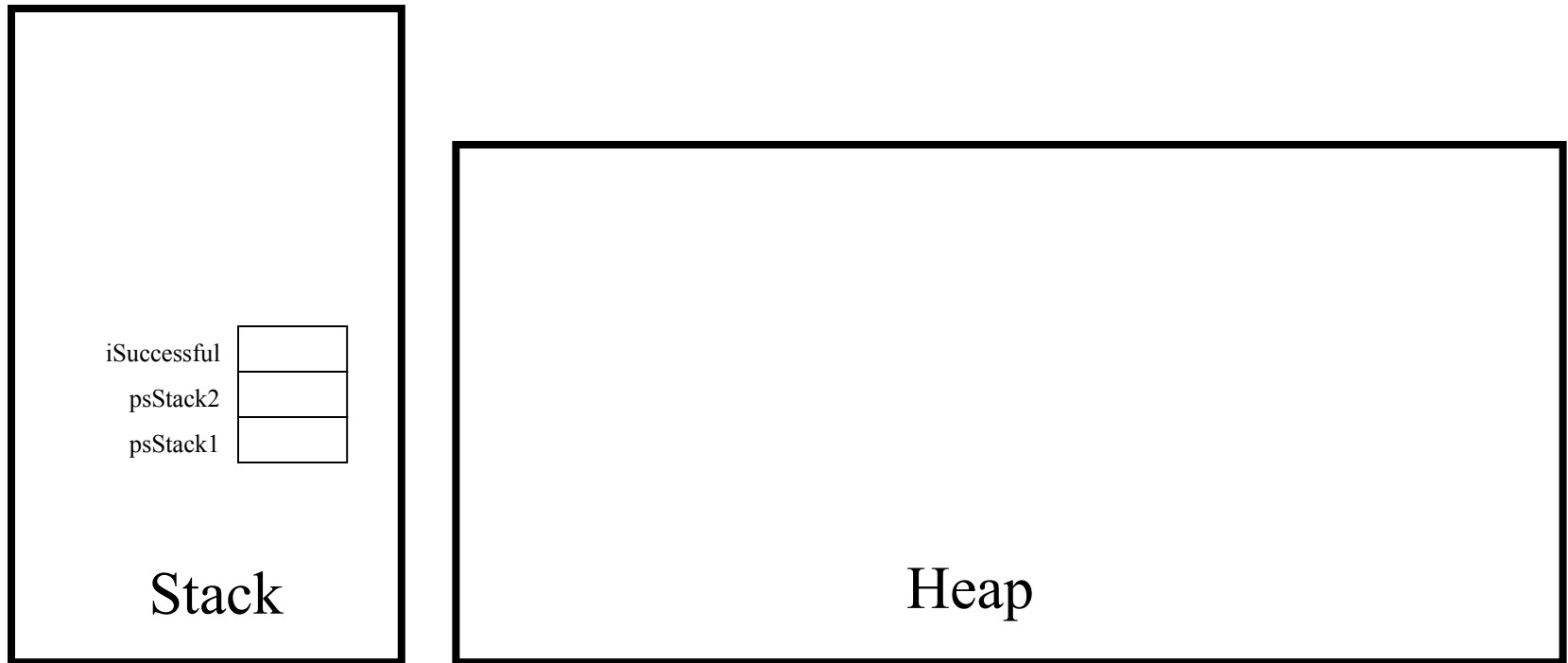

Princeton University
COS 217: Introduction to Programming Systems
Trace of teststack (Version 1)

```
struct Stack *psStack;
```

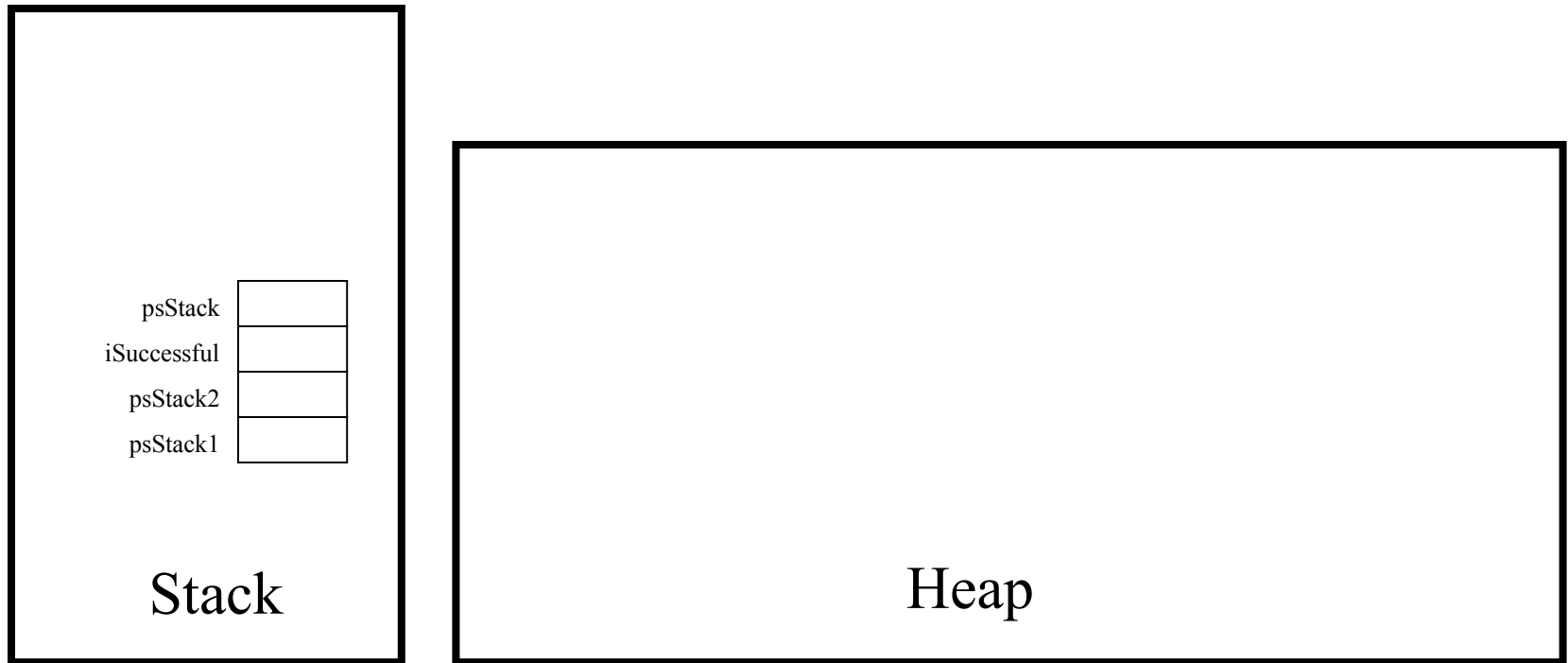

Princeton University
COS 217: Introduction to Programming Systems
Trace of teststack (Version 1)

```
psStack = (struct Stack*)malloc(sizeof(struct Stack));
```

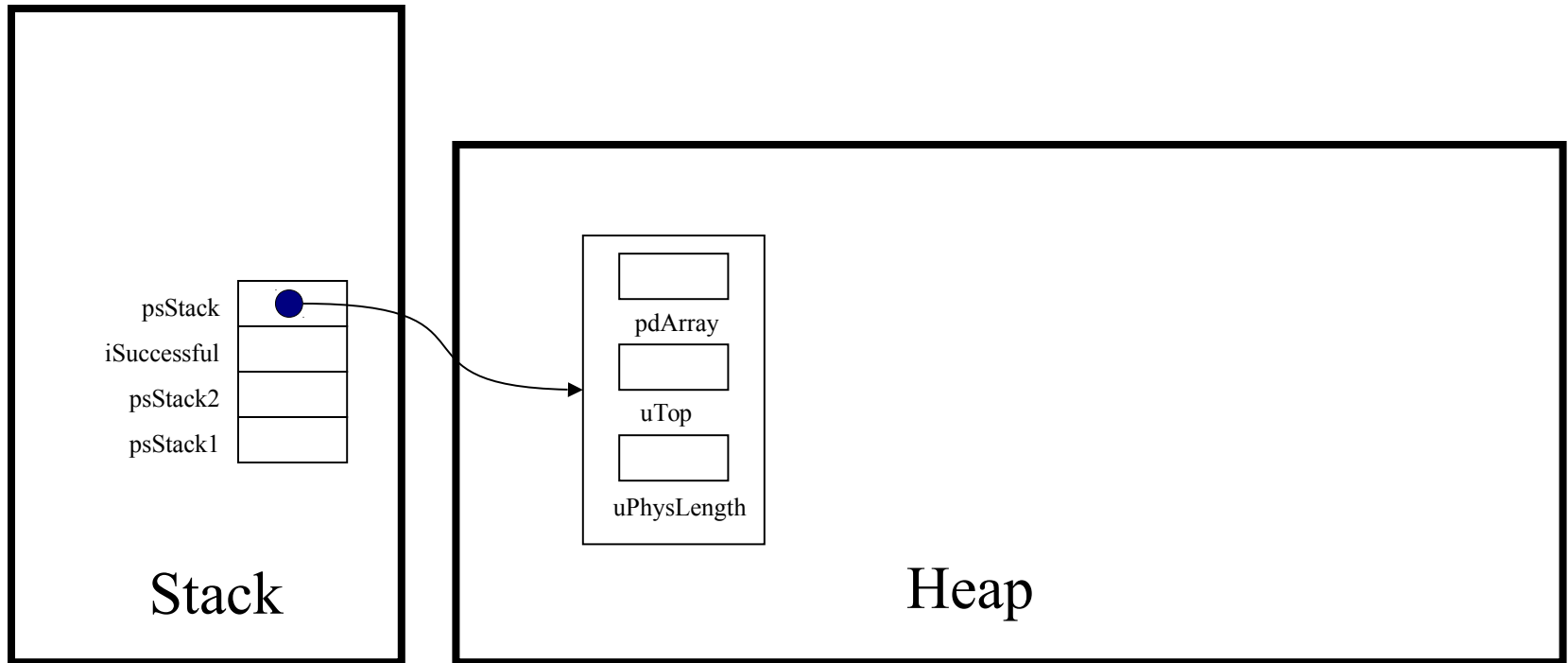

Princeton University
COS 217: Introduction to Programming Systems
Trace of teststack (Version 1)

```
if (psStack == NULL)
    return NULL;
```

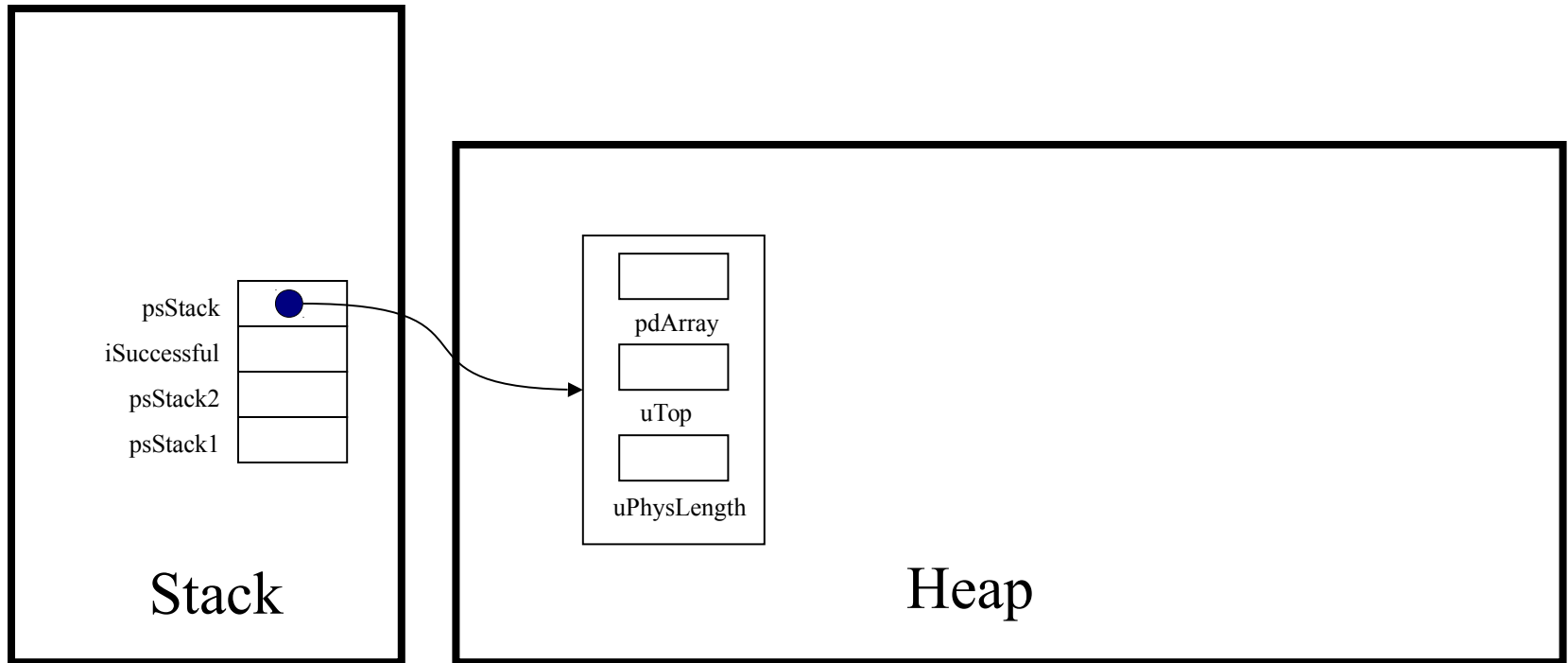

Princeton University
COS 217: Introduction to Programming Systems
Trace of teststack (Version 1)

```
psStack->pdArray = (double*)calloc(INITIAL_PHYS_LENGTH, sizeof(double));
```

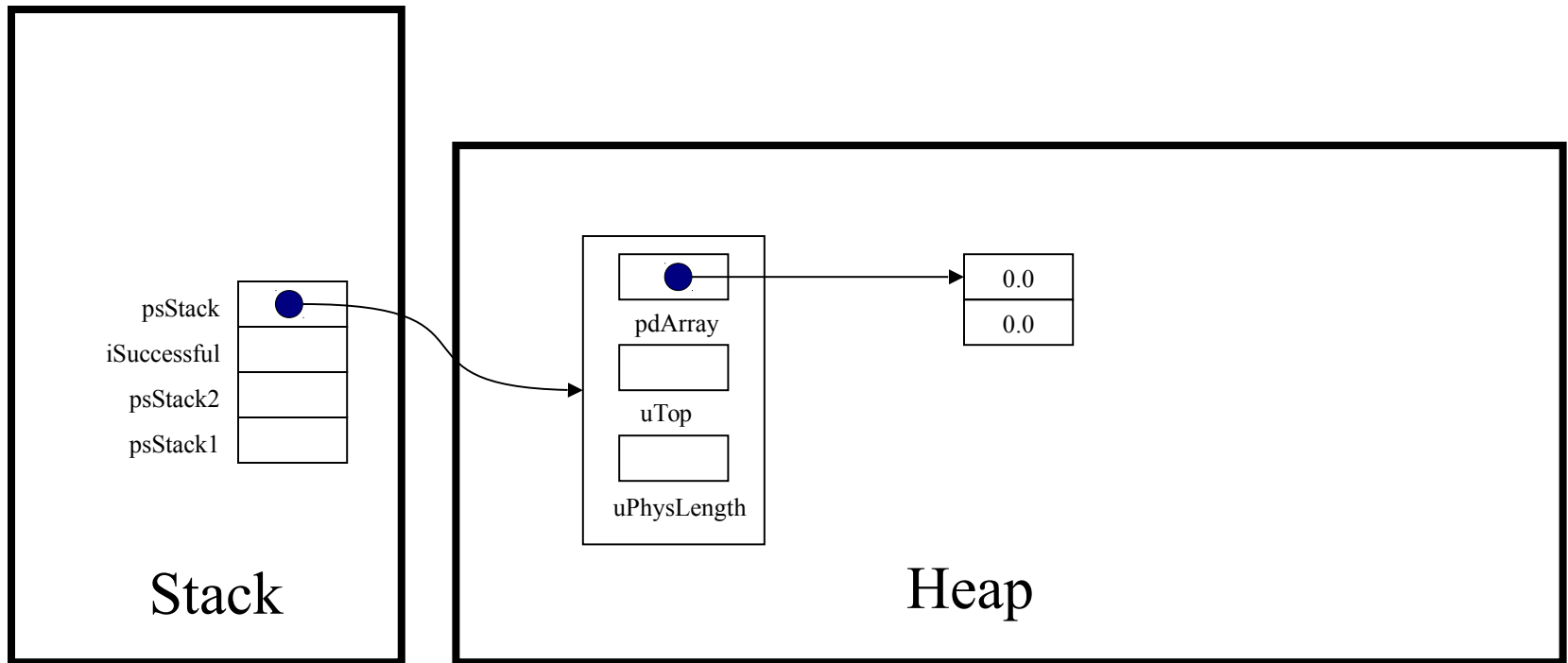

Princeton University
COS 217: Introduction to Programming Systems
Trace of teststack (Version 1)

```
if (psStack->pdArray == NULL)  
...
```

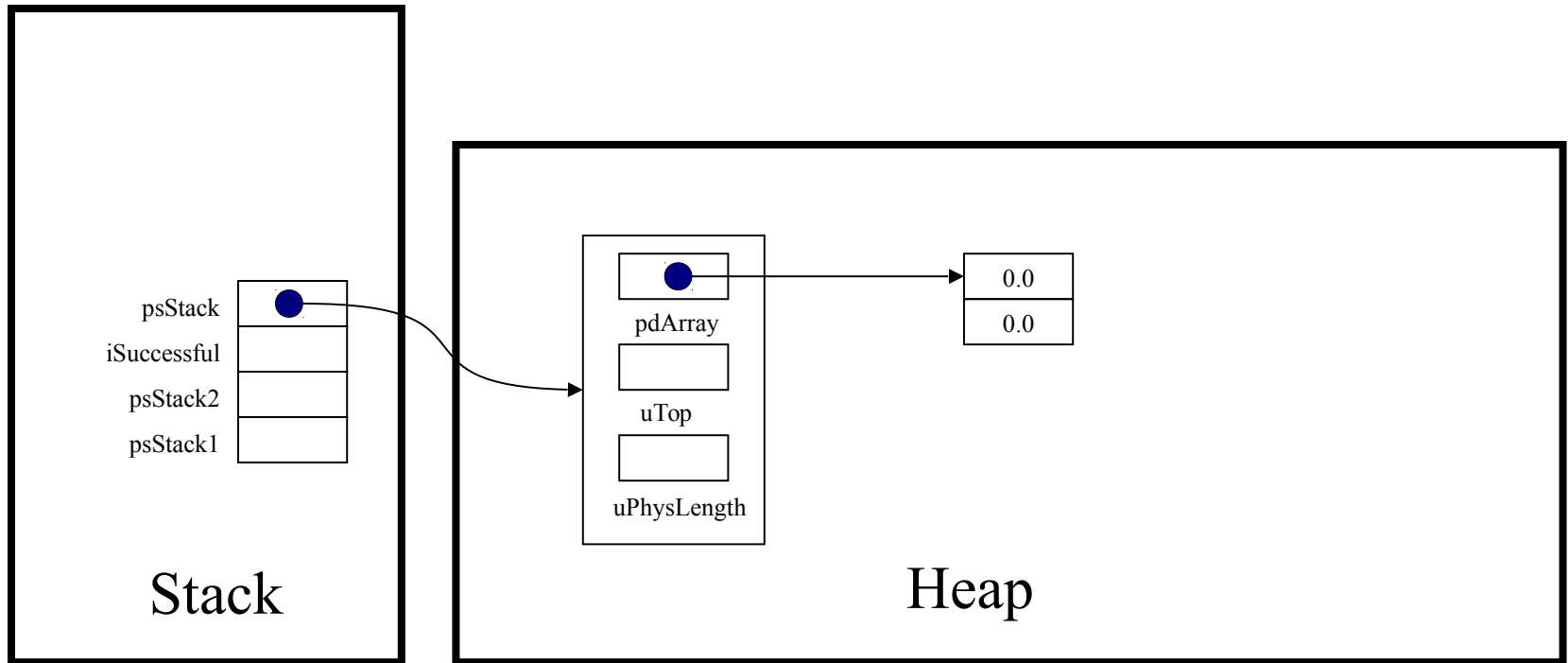

Princeton University
COS 217: Introduction to Programming Systems
Trace of teststack (Version 1)

```
psStack->uTop = 0;
```

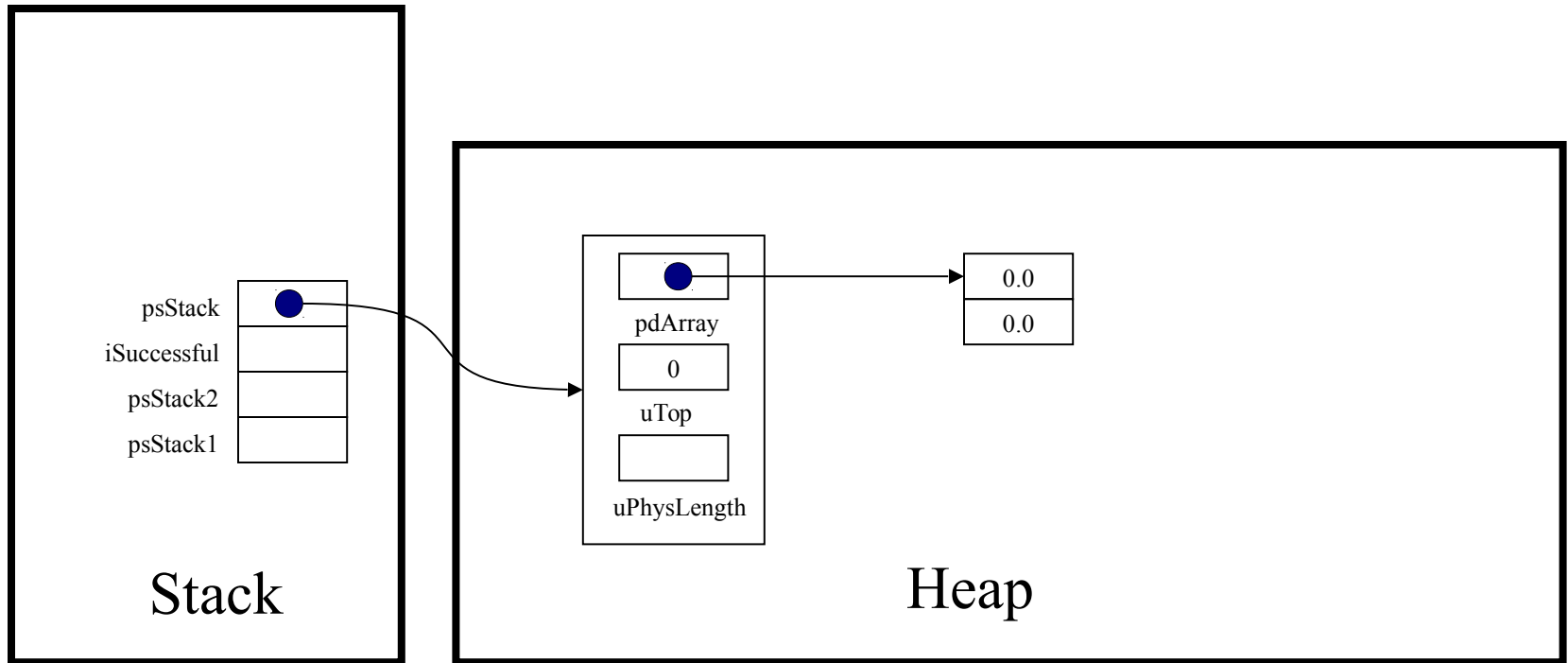

Princeton University
COS 217: Introduction to Programming Systems
Trace of teststack (Version 1)

```
psStack->uPhysLength = INITIAL_PHYS_LENGTH;
```

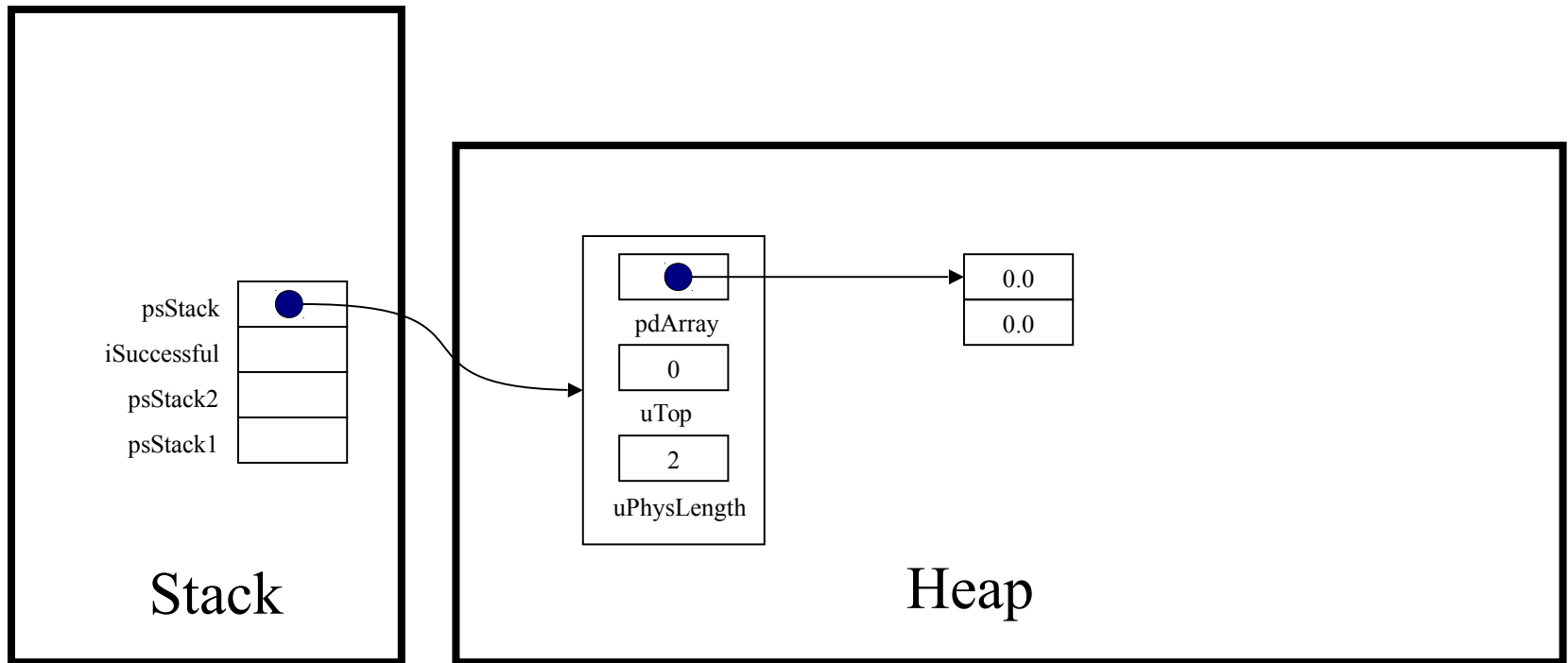

Princeton University
COS 217: Introduction to Programming Systems
Trace of teststack (Version 1)

```
return psStack;
```

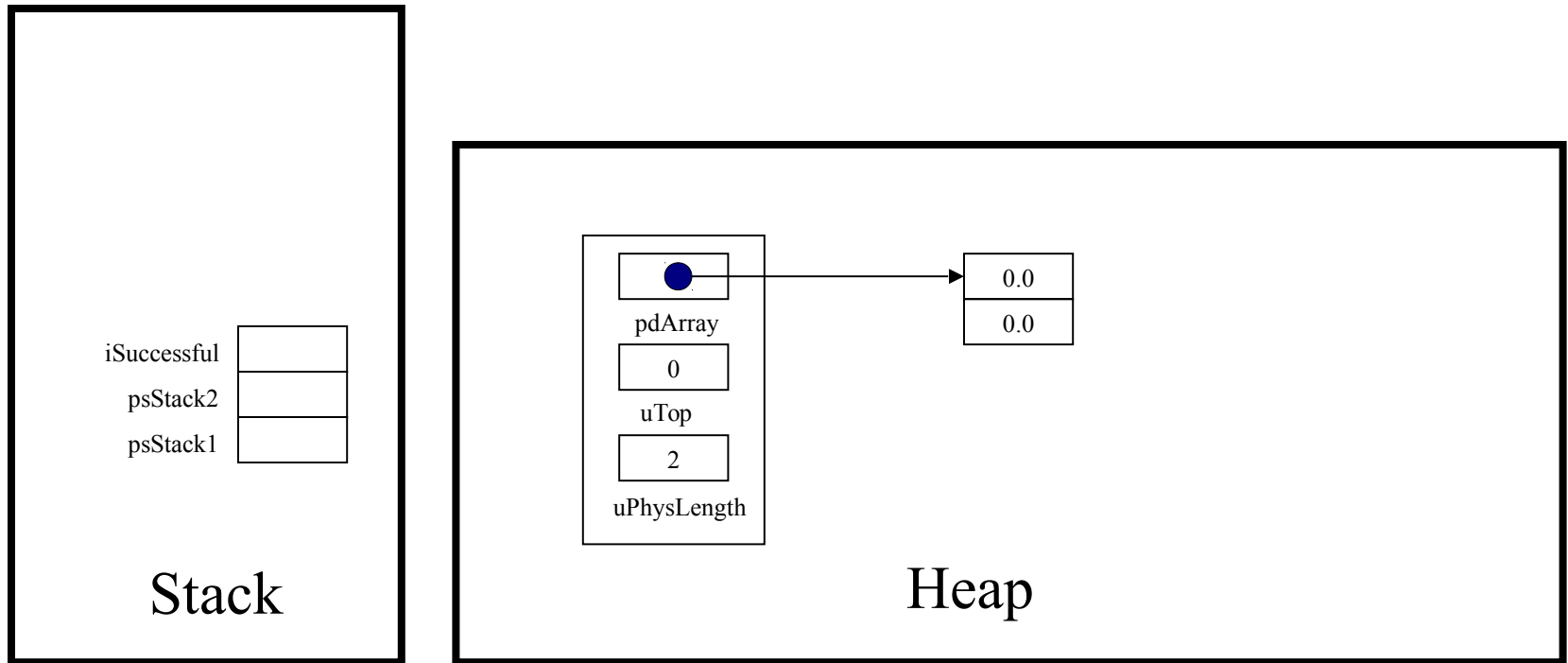

Princeton University
COS 217: Introduction to Programming Systems
Trace of teststack (Version 1)

```
psStack1 = Stack_new();
```

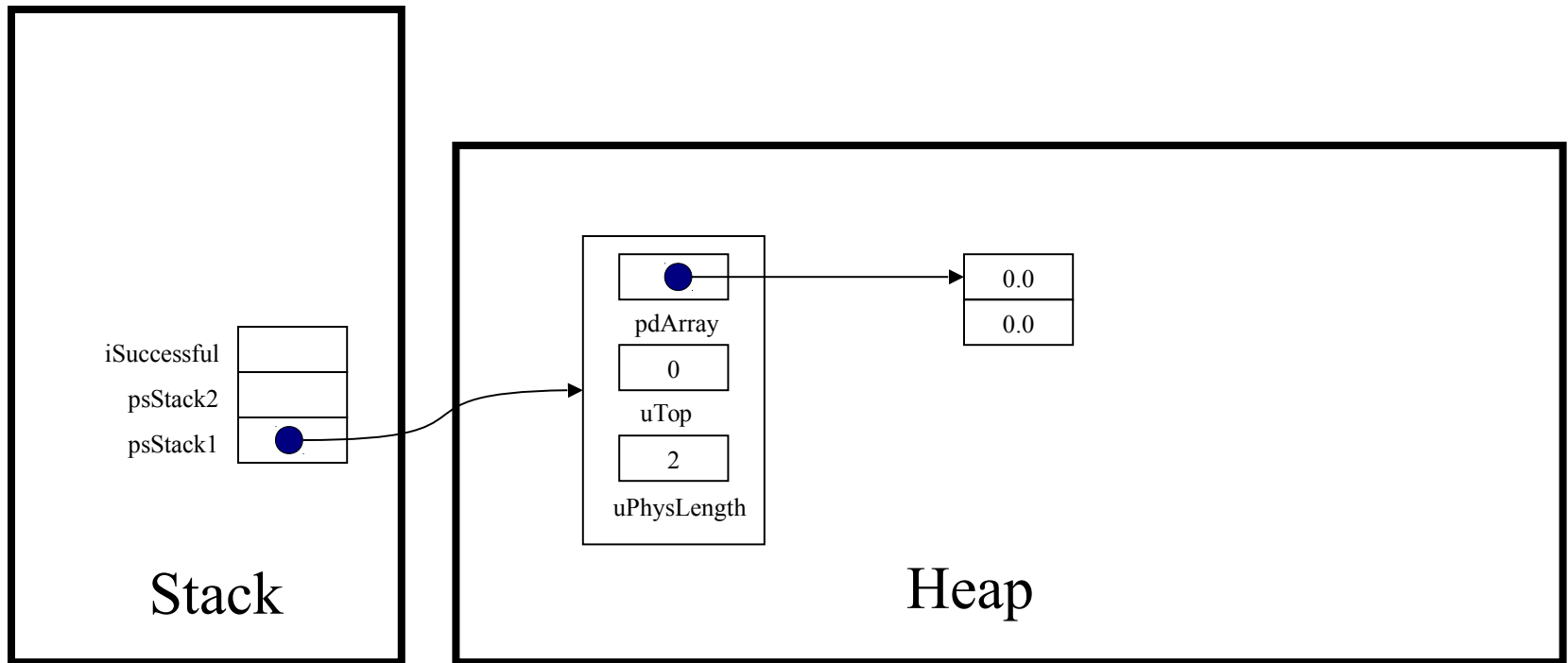

Princeton University
COS 217: Introduction to Programming Systems
Trace of teststack (Version 1)

```
if (psStack1 == NULL) handleMemoryError();
```

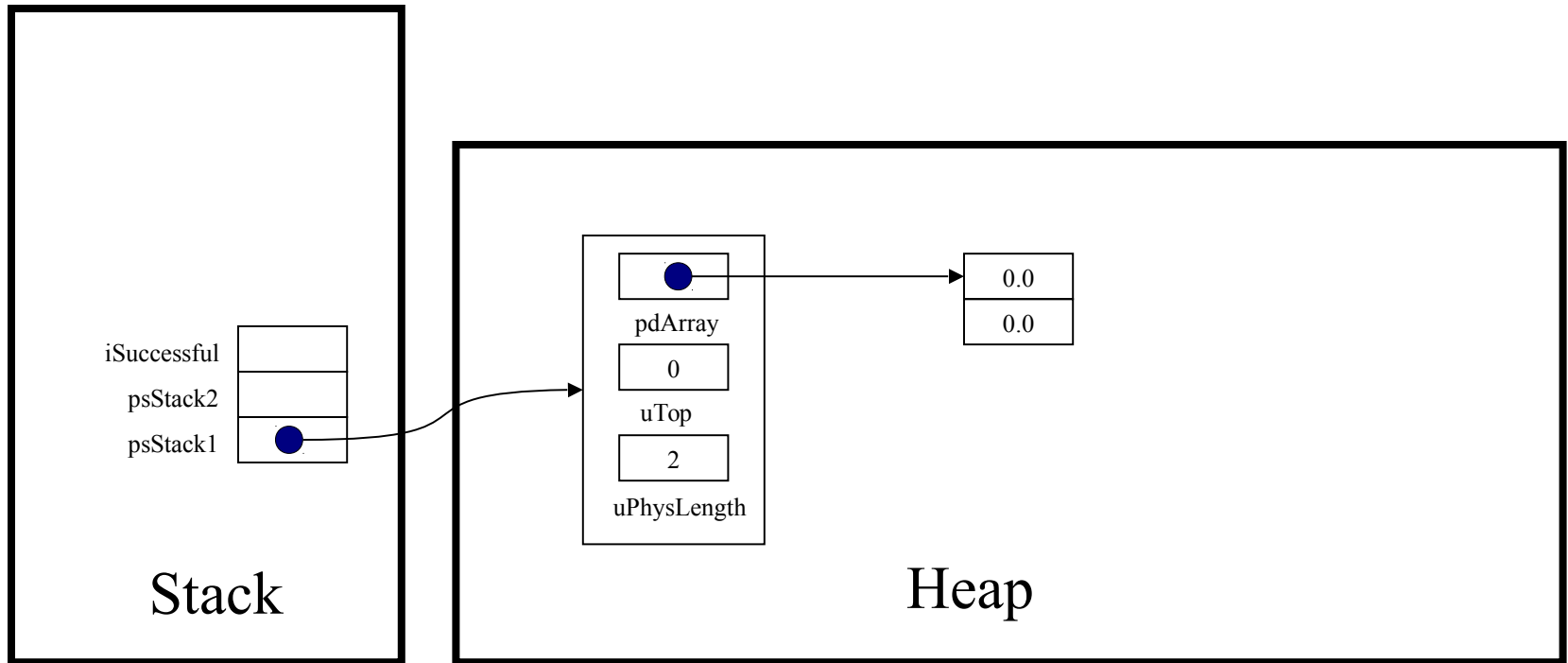

Princeton University
COS 217: Introduction to Programming Systems
Trace of teststack (Version 1)

```
iSuccessful = Stack_push(psStack1, 1.1);
```

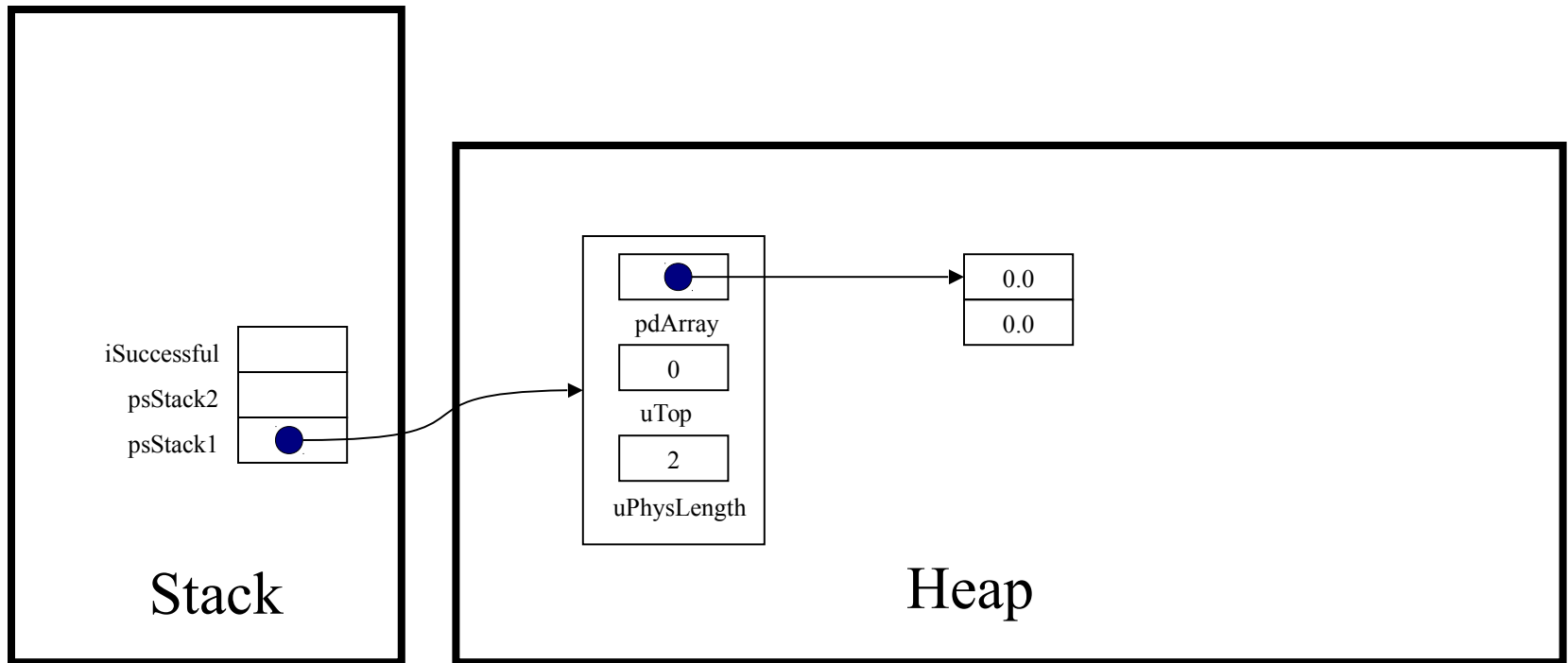

Princeton University
COS 217: Introduction to Programming Systems
Trace of teststack (Version 1)

```
int Stack_push(struct Stack *psStack, double dItem)
```

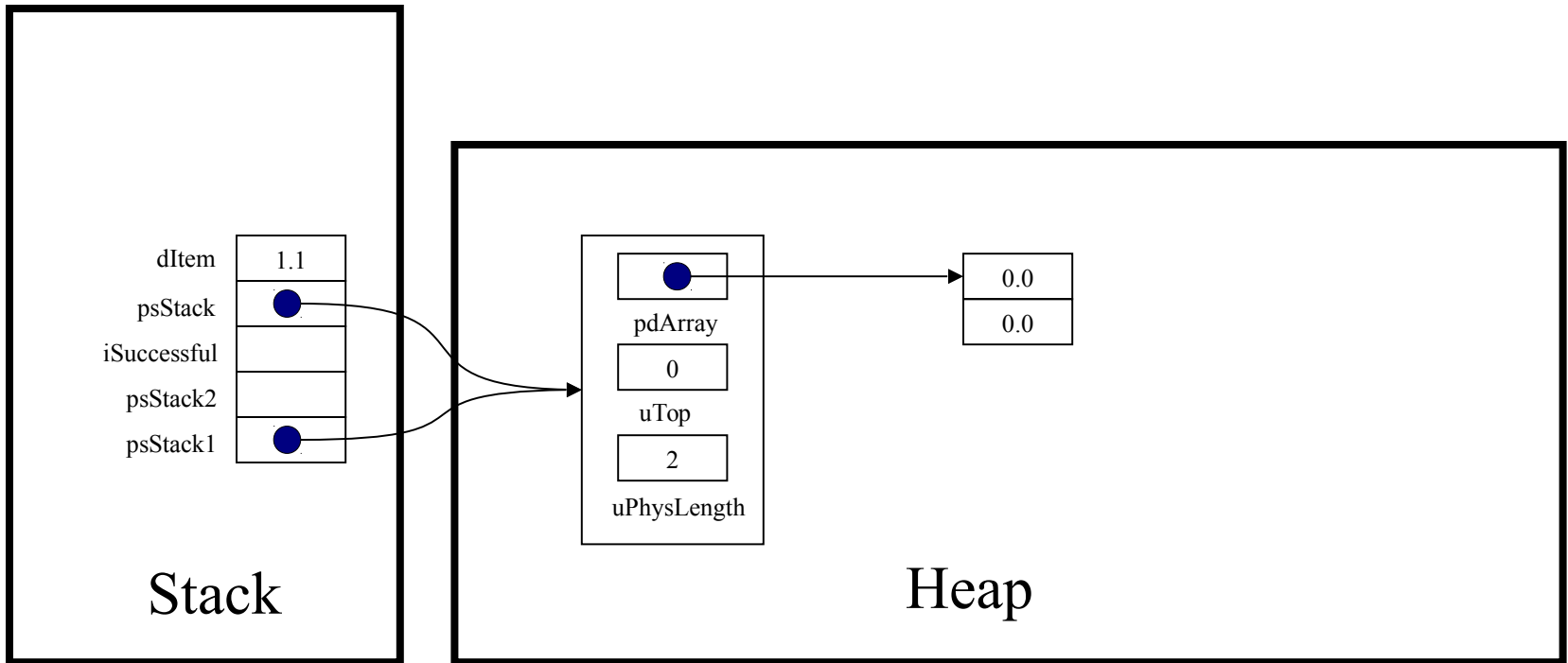

Princeton University
COS 217: Introduction to Programming Systems
Trace of teststack (Version 1)

```
int iSuccessful;
```

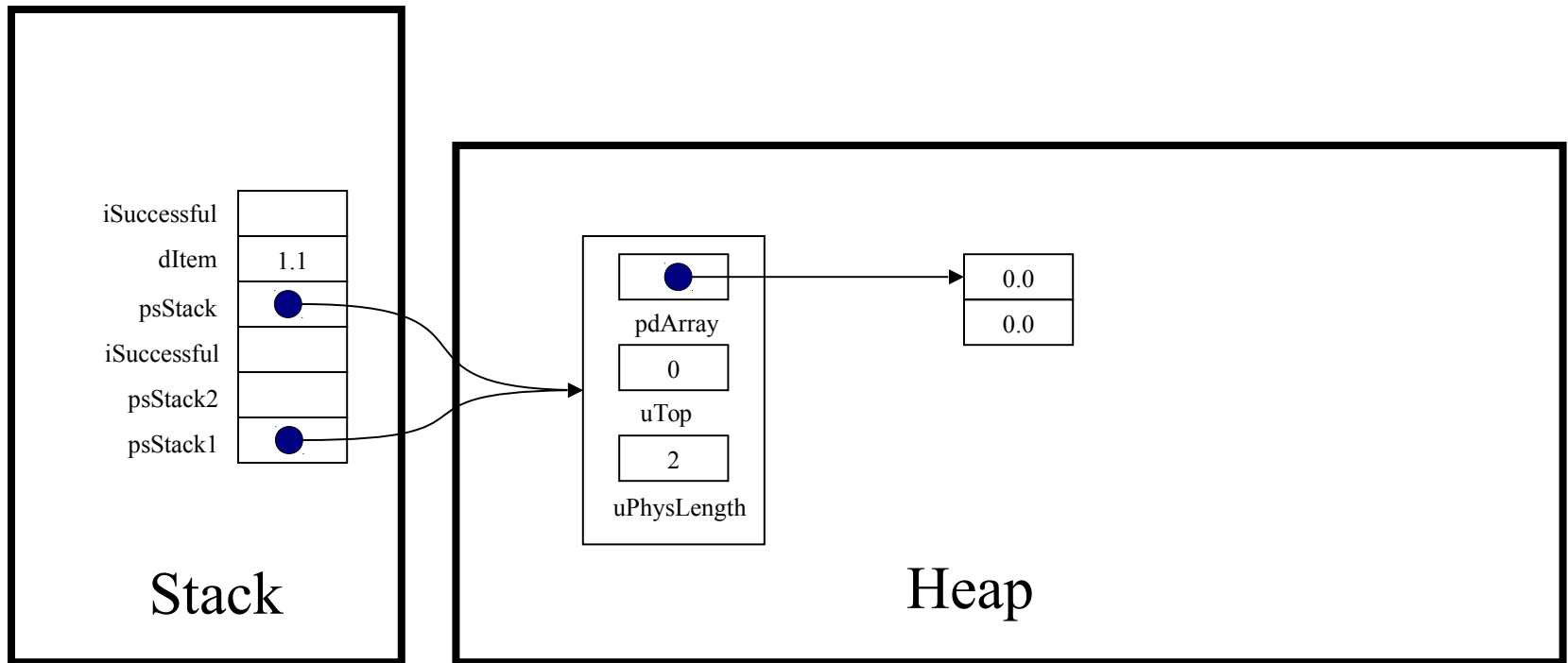

Princeton University
COS 217: Introduction to Programming Systems
Trace of teststack (Version 1)

```
assert (psStack != NULL);
```

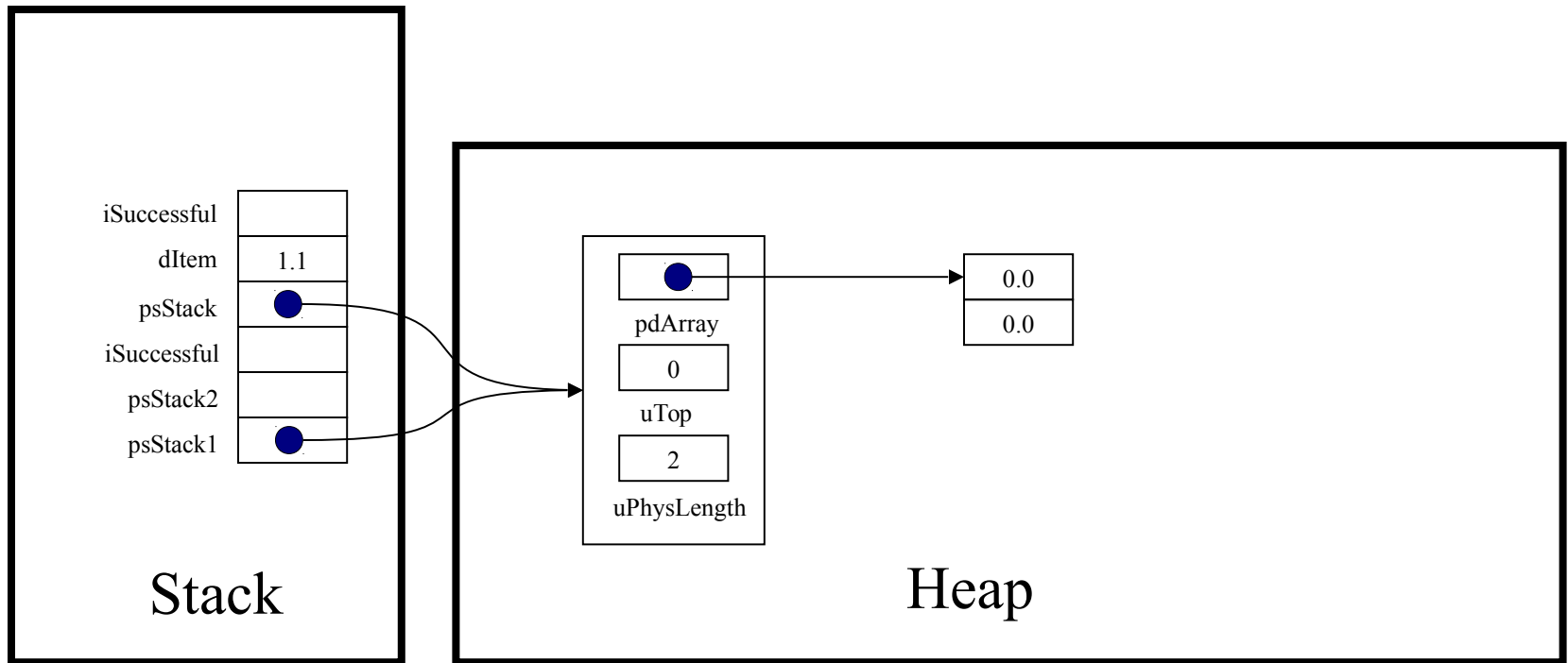

Princeton University
COS 217: Introduction to Programming Systems
Trace of teststack (Version 1)

```
if (psStack->uTop == psStack->uPhysLength)  
...
```

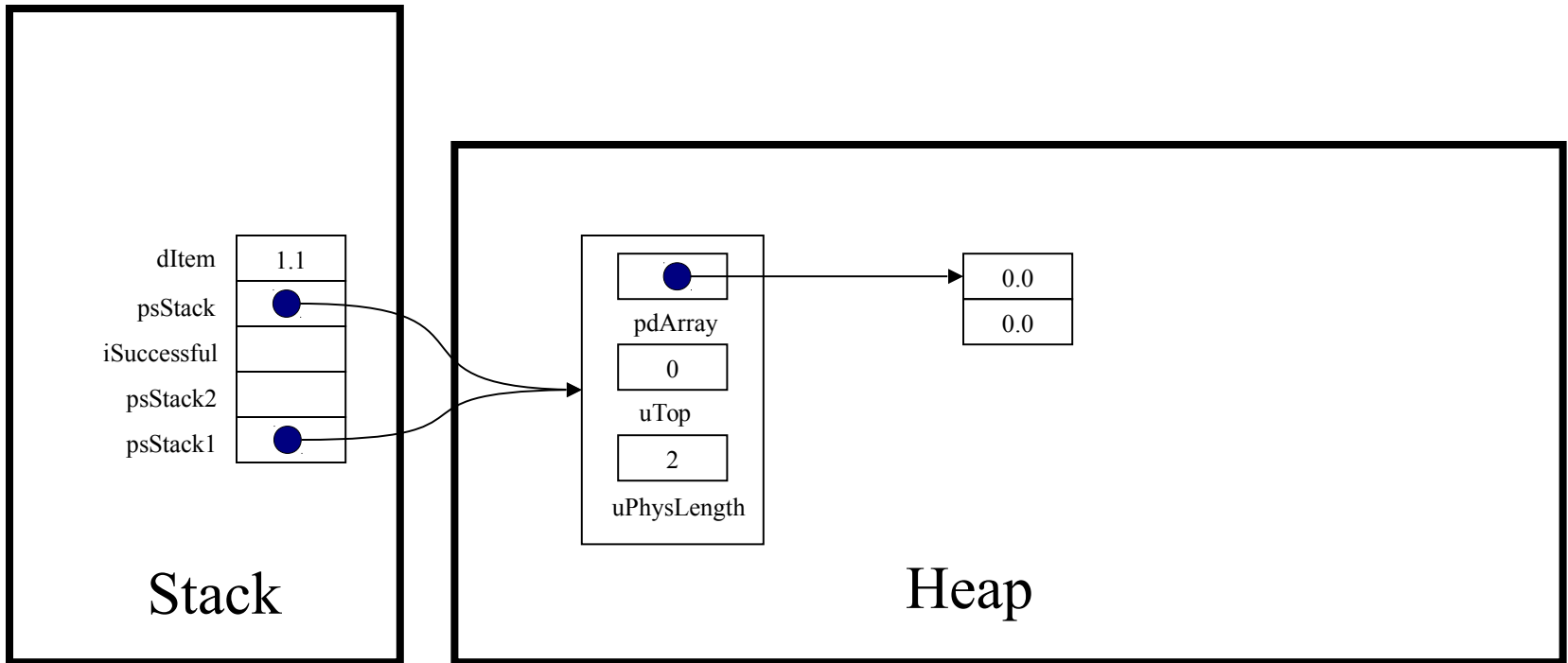

Princeton University
COS 217: Introduction to Programming Systems
Trace of teststack (Version 1)

```
(psStack->pdArray)[psStack->uTop] = dItem;
```

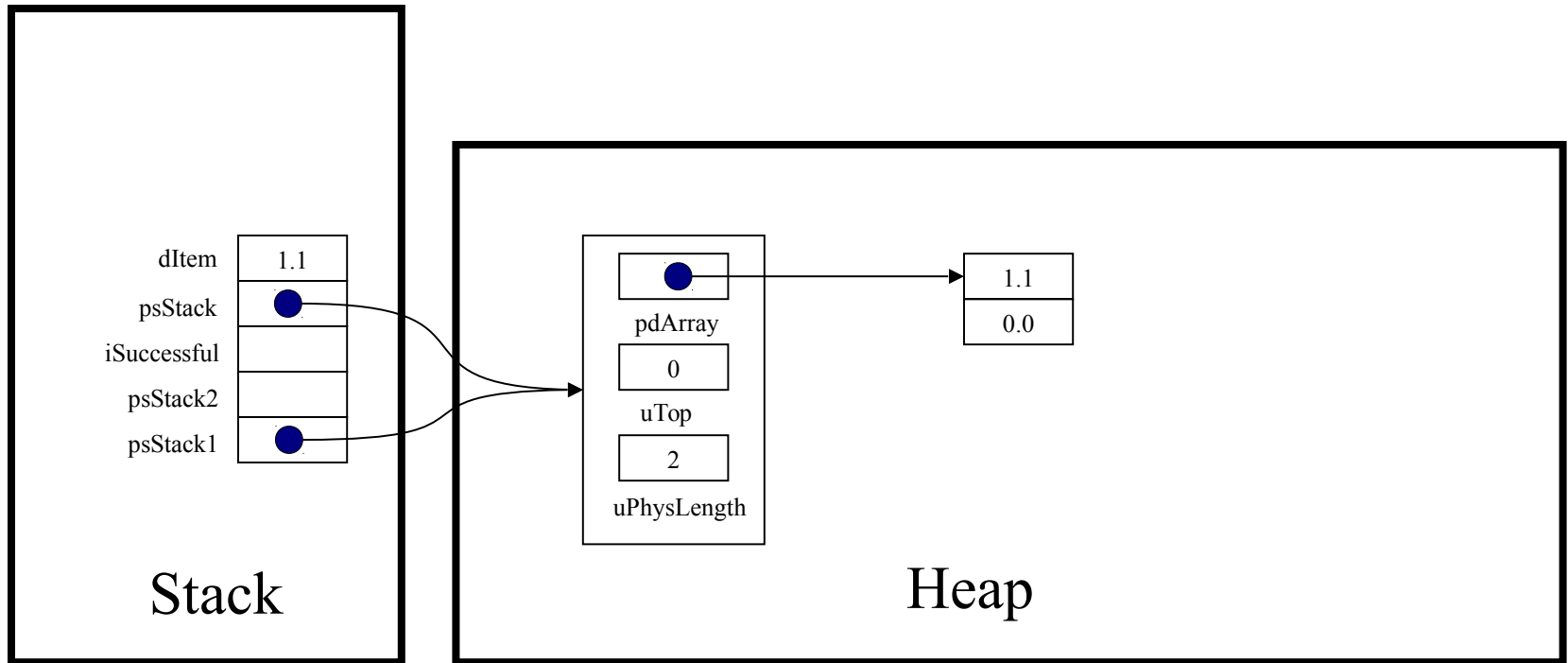

Princeton University
COS 217: Introduction to Programming Systems
Trace of teststack (Version 1)

```
(psStack->uTop) ++;
```

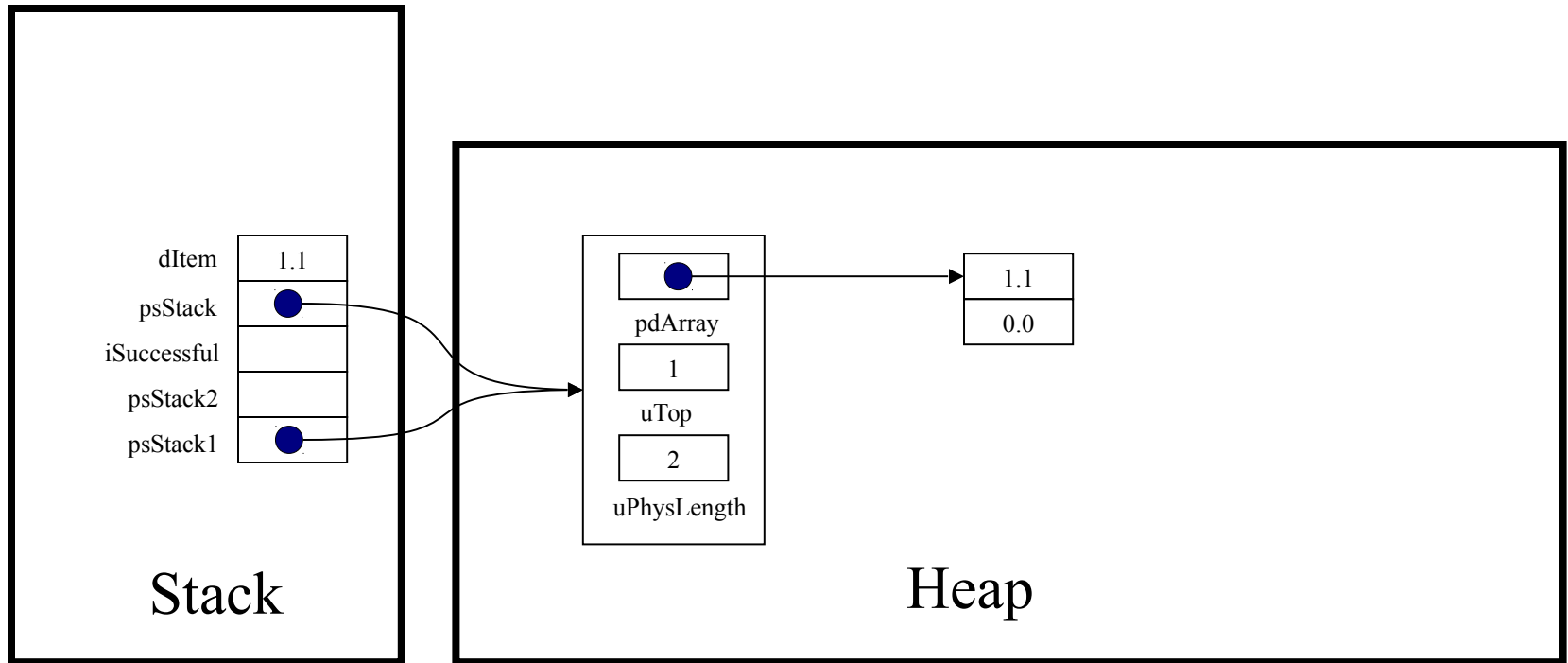

Princeton University
COS 217: Introduction to Programming Systems
Trace of teststack (Version 1)

```
return 1;
```

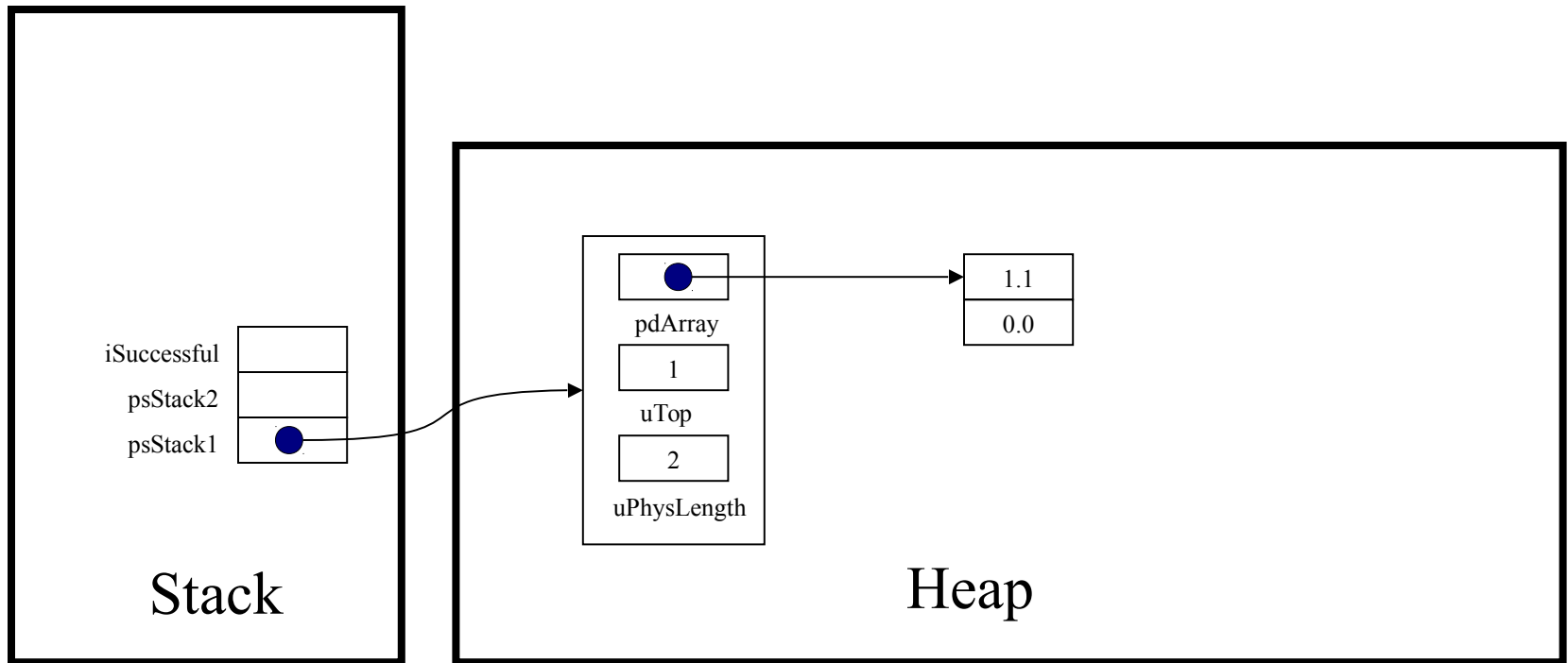

Princeton University
COS 217: Introduction to Programming Systems
Trace of teststack (Version 1)

```
iSuccessful = Stack_push(psStack1, 1.1);
```

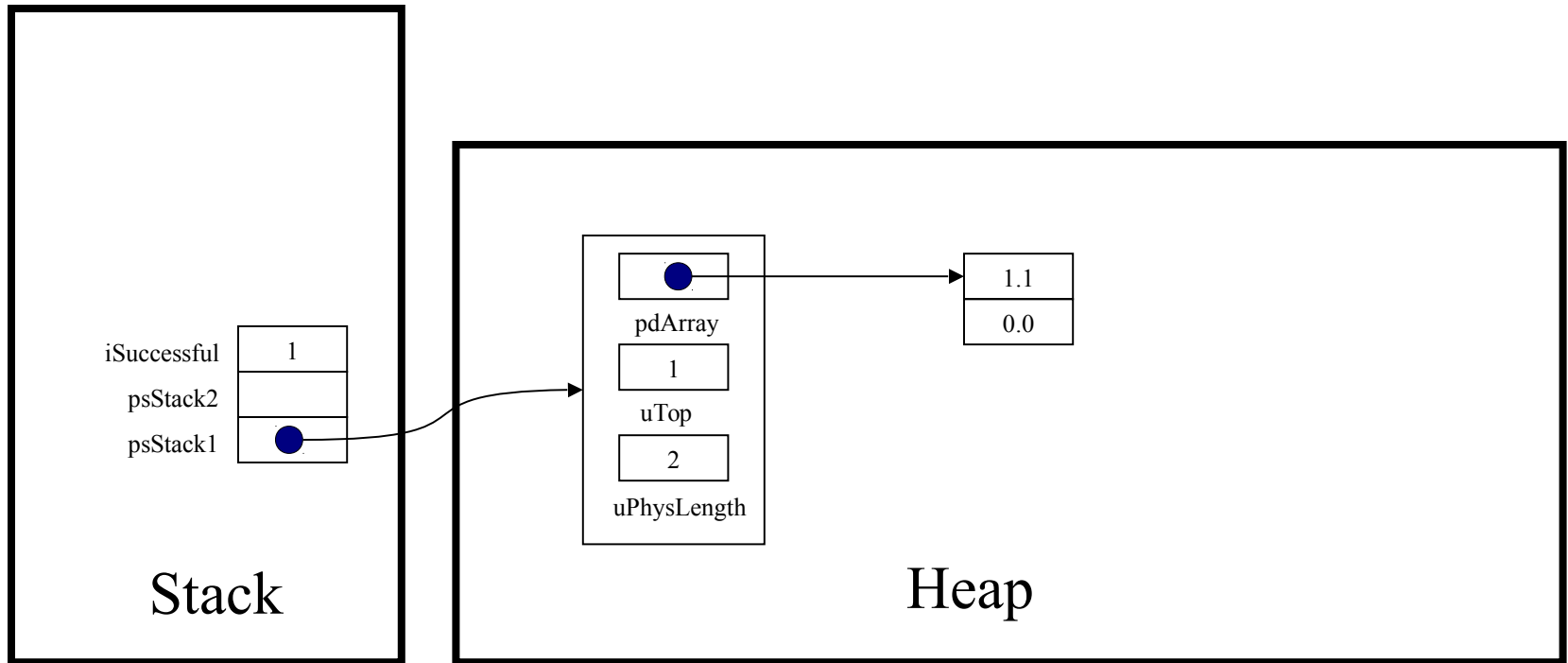

Princeton University
COS 217: Introduction to Programming Systems
Trace of teststack (Version 1)

```
if (! iSuccessful) handleMemoryError();
```

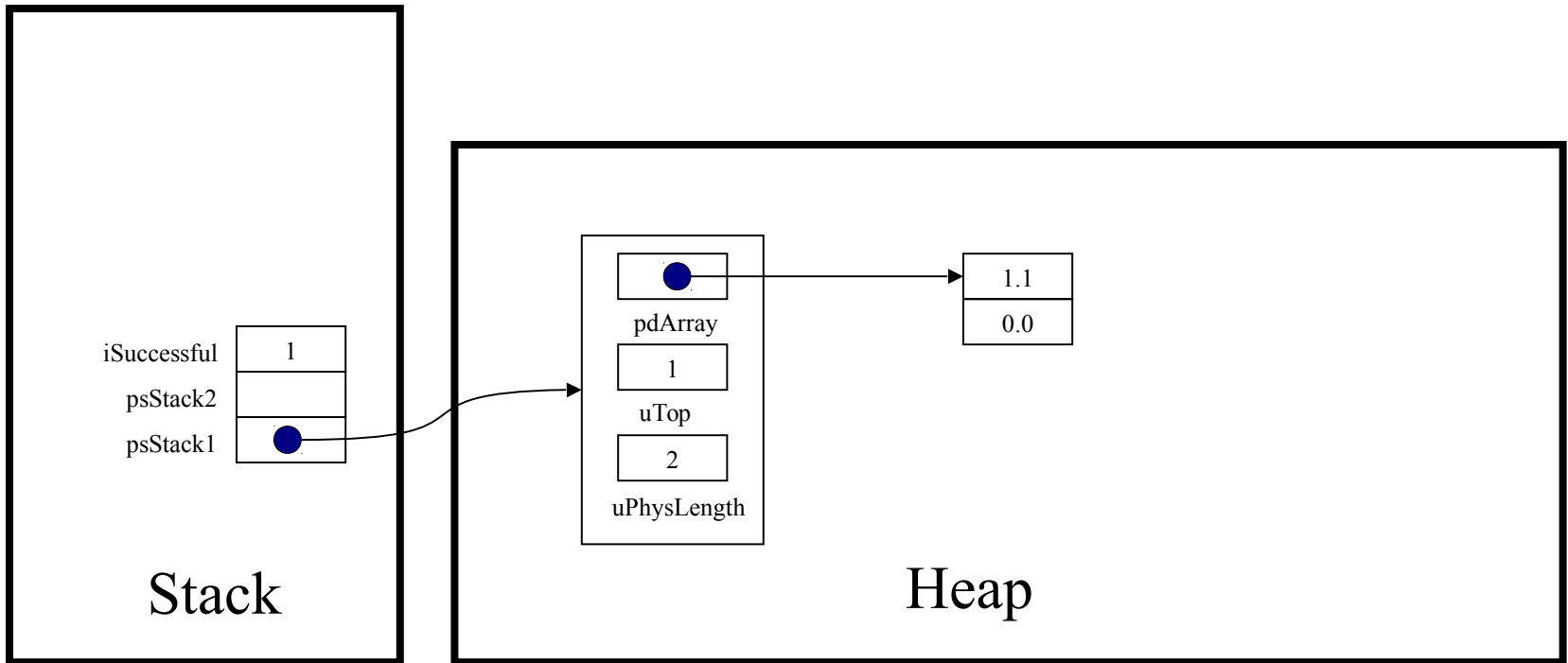

Princeton University
COS 217: Introduction to Programming Systems
Trace of teststack (Version 1)

```
iSuccessful = Stack_push(psStack1, 2.2);
```

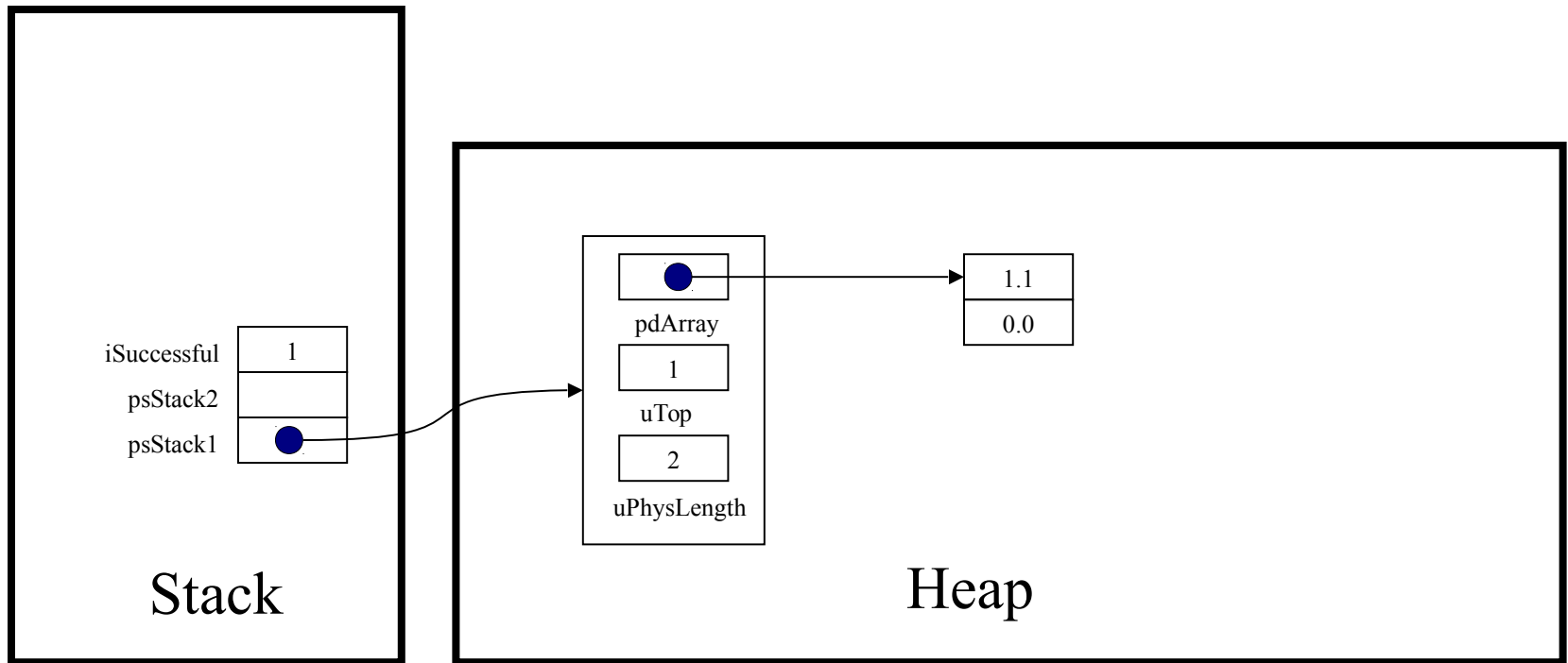

Princeton University
COS 217: Introduction to Programming Systems
Trace of teststack (Version 1)

```
int Stack_push(struct Stack *psStack, double dItem)
```

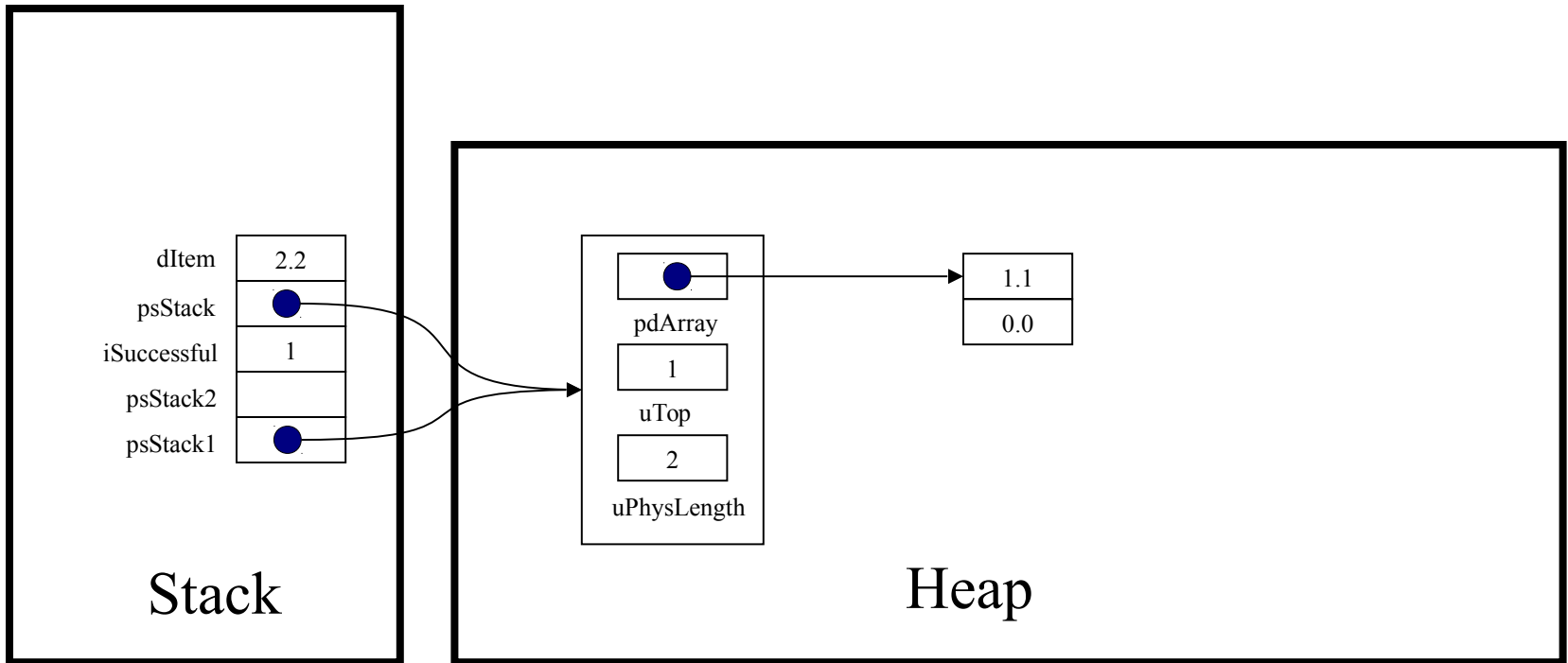

Princeton University
COS 217: Introduction to Programming Systems
Trace of teststack (Version 1)

```
int iSuccessful;
```

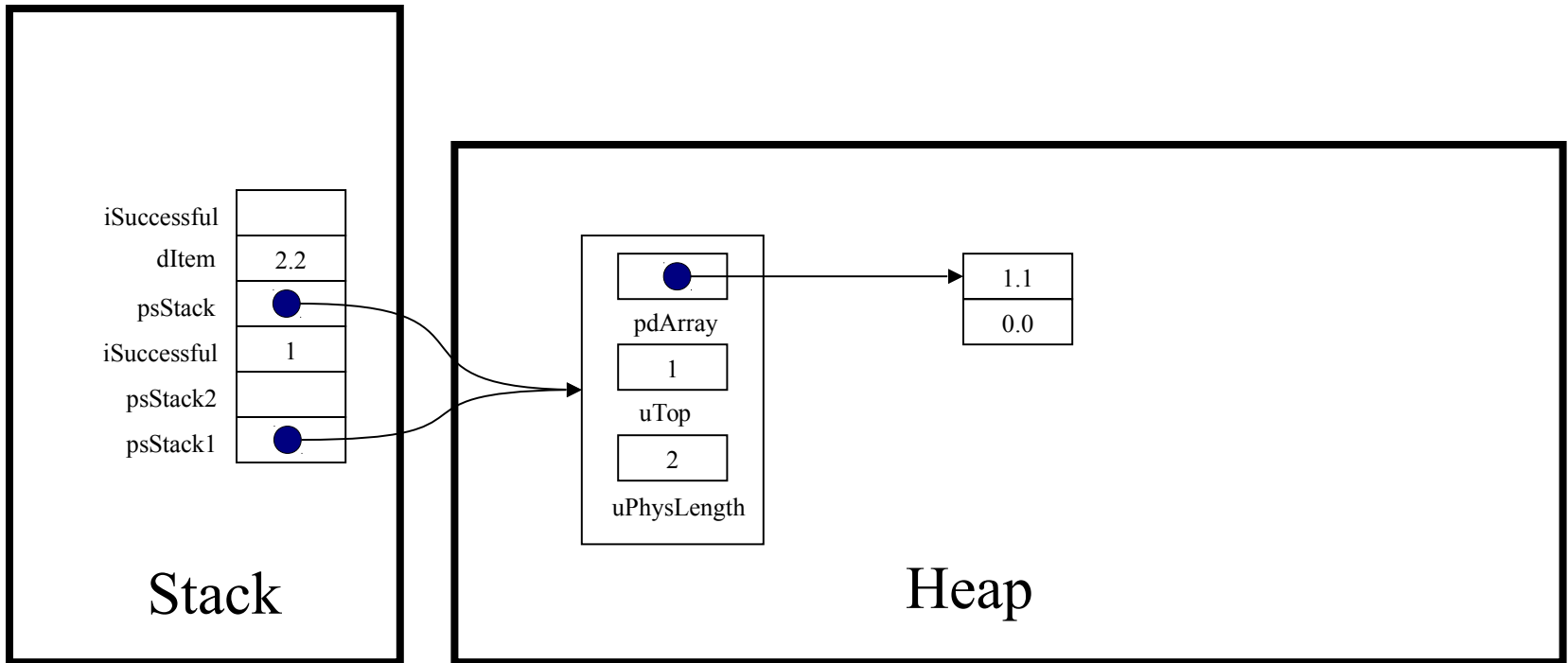

Princeton University
COS 217: Introduction to Programming Systems
Trace of teststack (Version 1)

```
assert (psStack != NULL);
```

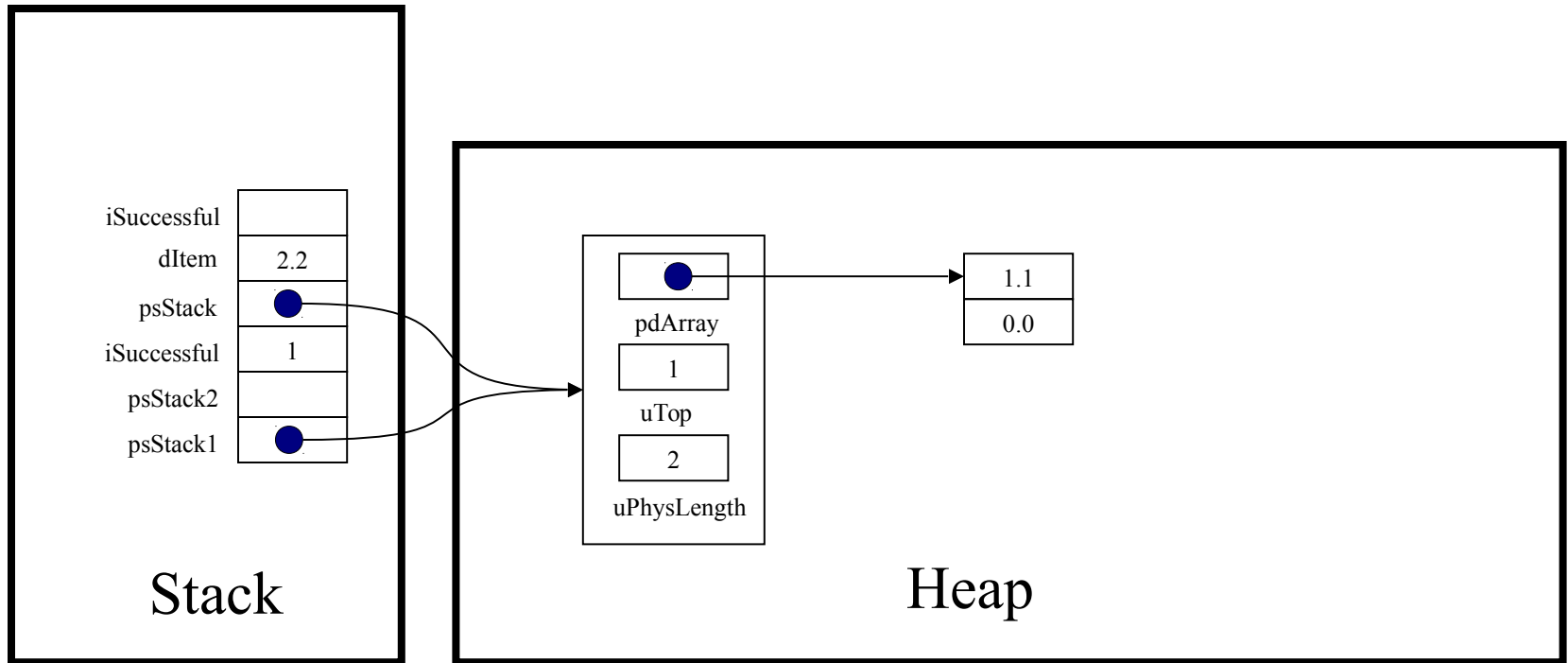

Princeton University
COS 217: Introduction to Programming Systems
Trace of teststack (Version 1)

```
if (psStack->uTop == psStack->uPhysLength)  
...
```

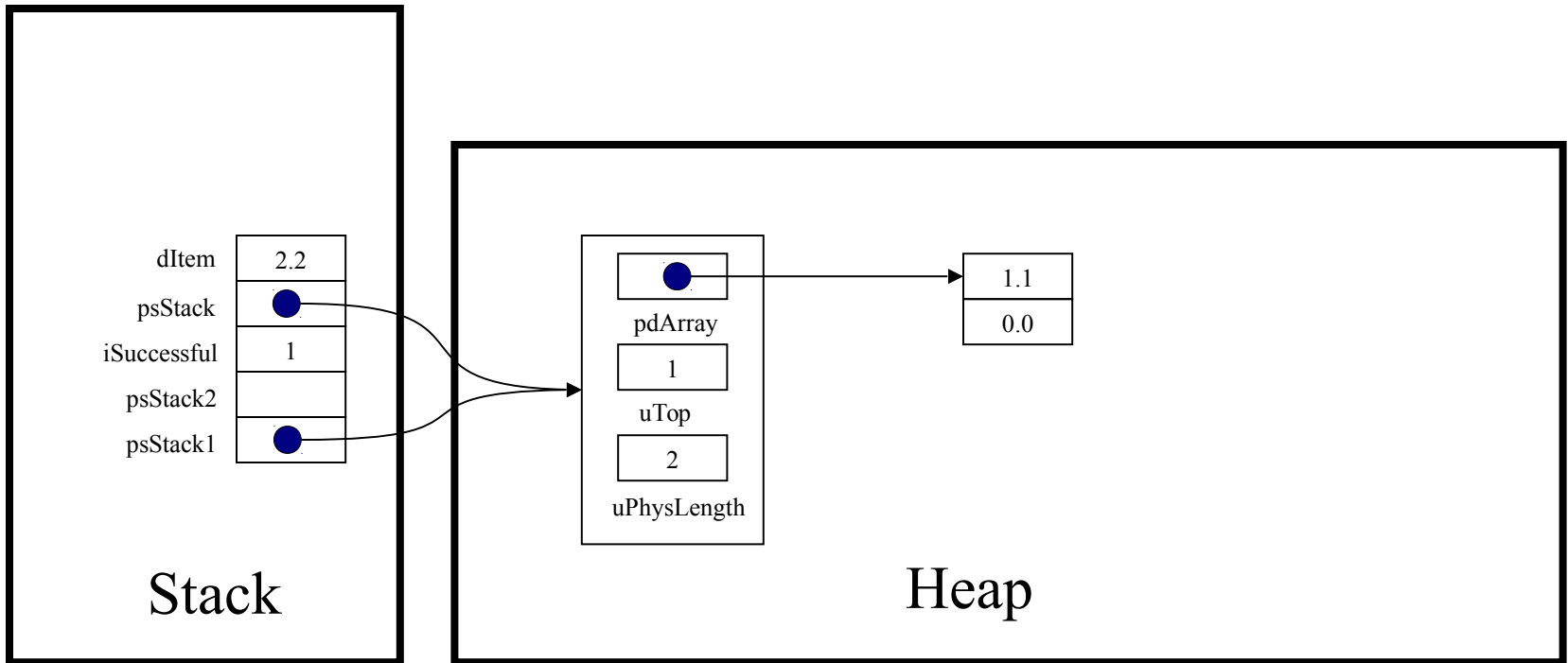

Princeton University
COS 217: Introduction to Programming Systems
Trace of teststack (Version 1)

```
(psStack->pdArray)[psStack->uTop] = dItem;
```

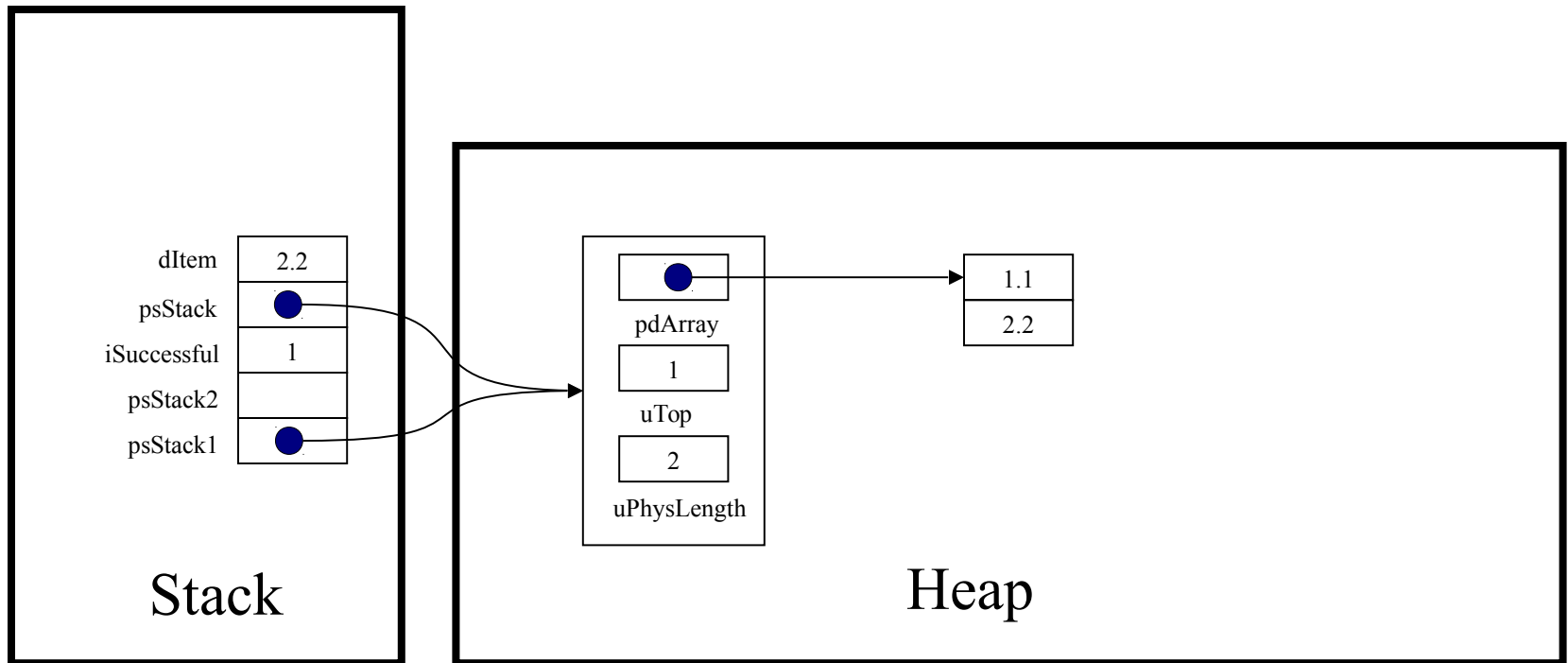

Princeton University
COS 217: Introduction to Programming Systems
Trace of teststack (Version 1)

```
(psStack->uTop) ++;
```

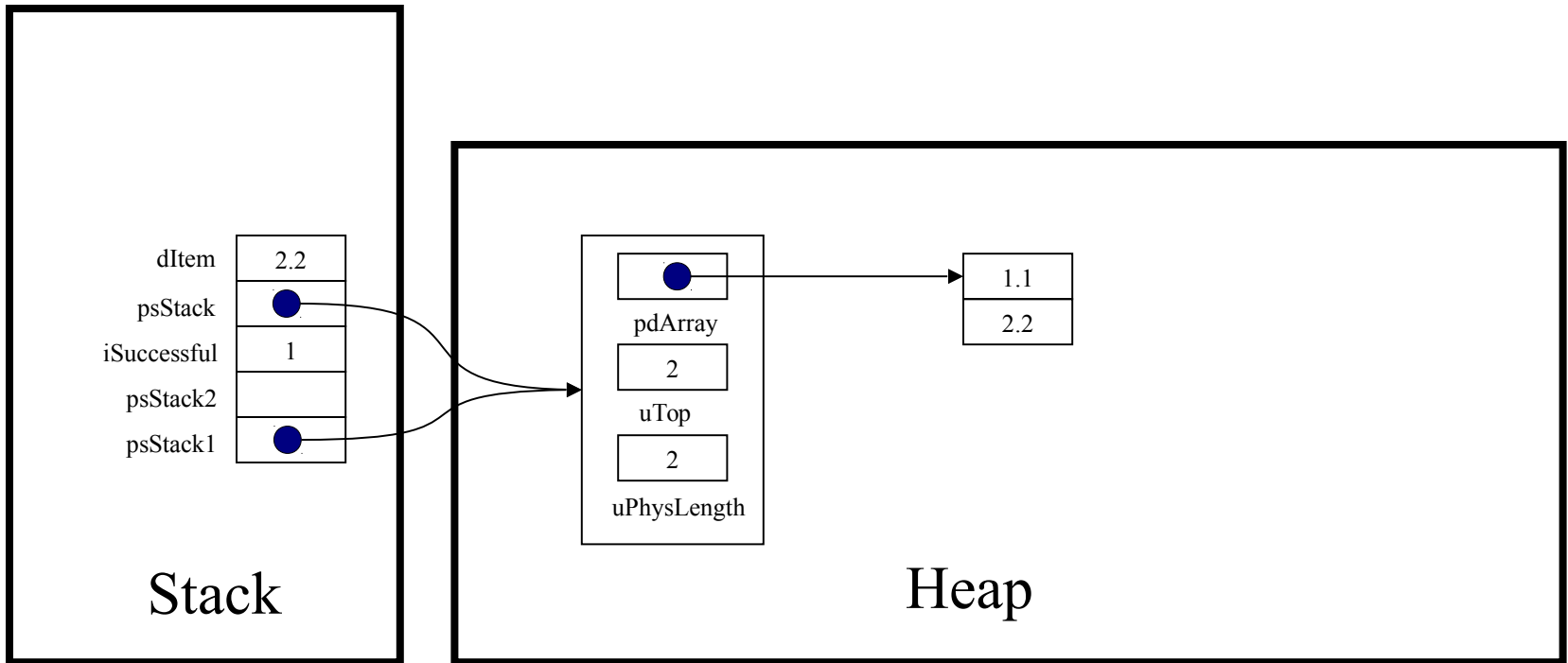

Princeton University
COS 217: Introduction to Programming Systems
Trace of teststack (Version 1)

```
return 1;
```

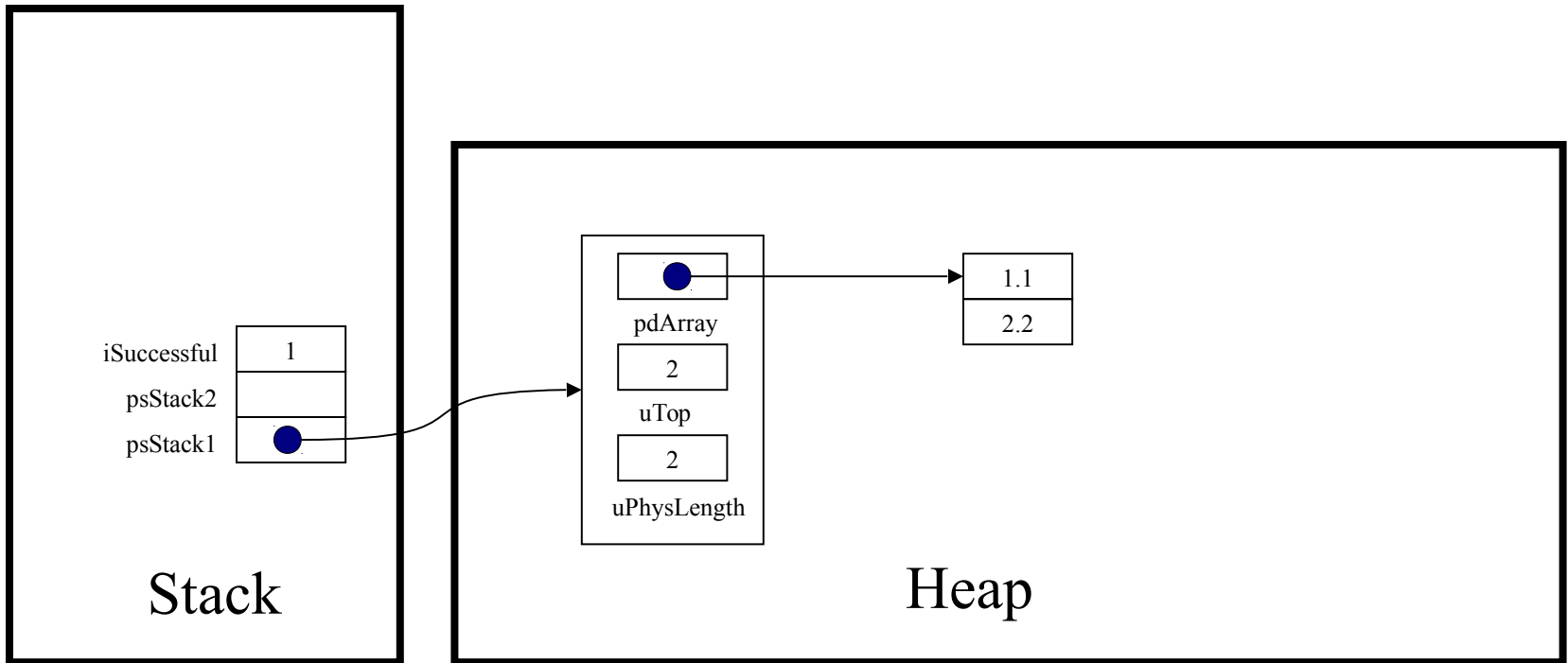

Princeton University
COS 217: Introduction to Programming Systems
Trace of teststack (Version 1)

```
iSuccessful = Stack_push(psStack1, 2.2);
```

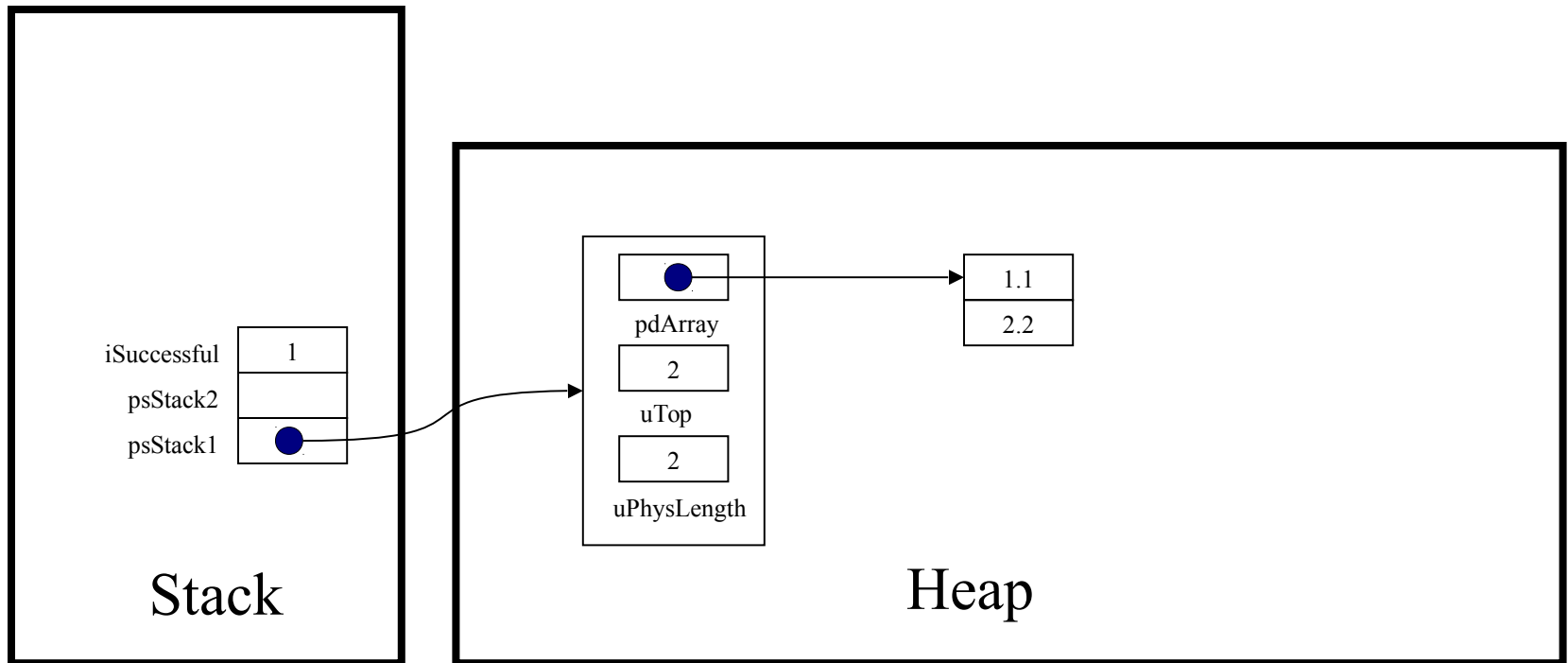

Princeton University
COS 217: Introduction to Programming Systems
Trace of teststack (Version 1)

```
if (! iSuccessful) handleMemoryError();
```

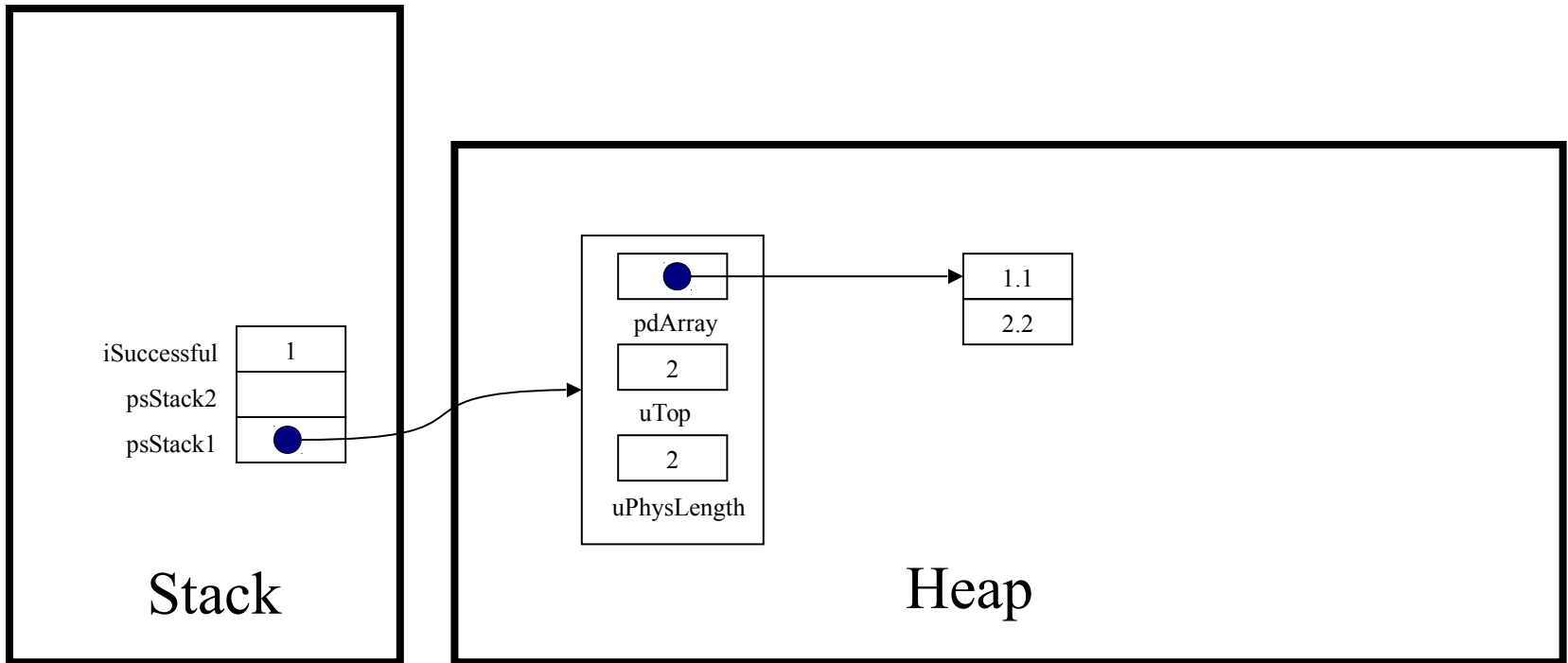

Princeton University
COS 217: Introduction to Programming Systems
Trace of teststack (Version 1)

```
iSuccessful = Stack_push(psStack1, 3.3);
```

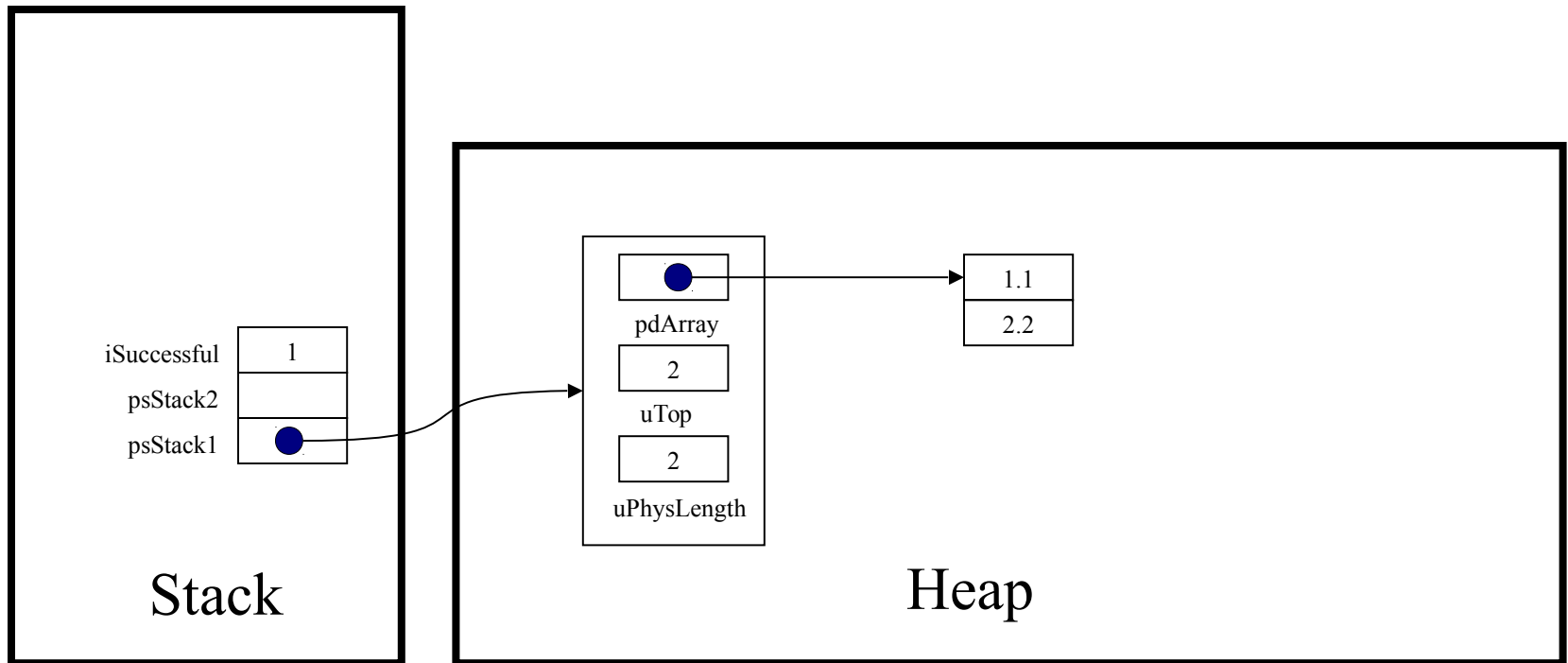

Princeton University
COS 217: Introduction to Programming Systems
Trace of teststack (Version 1)

```
int Stack_push(struct Stack *psStack, double dItem)
```

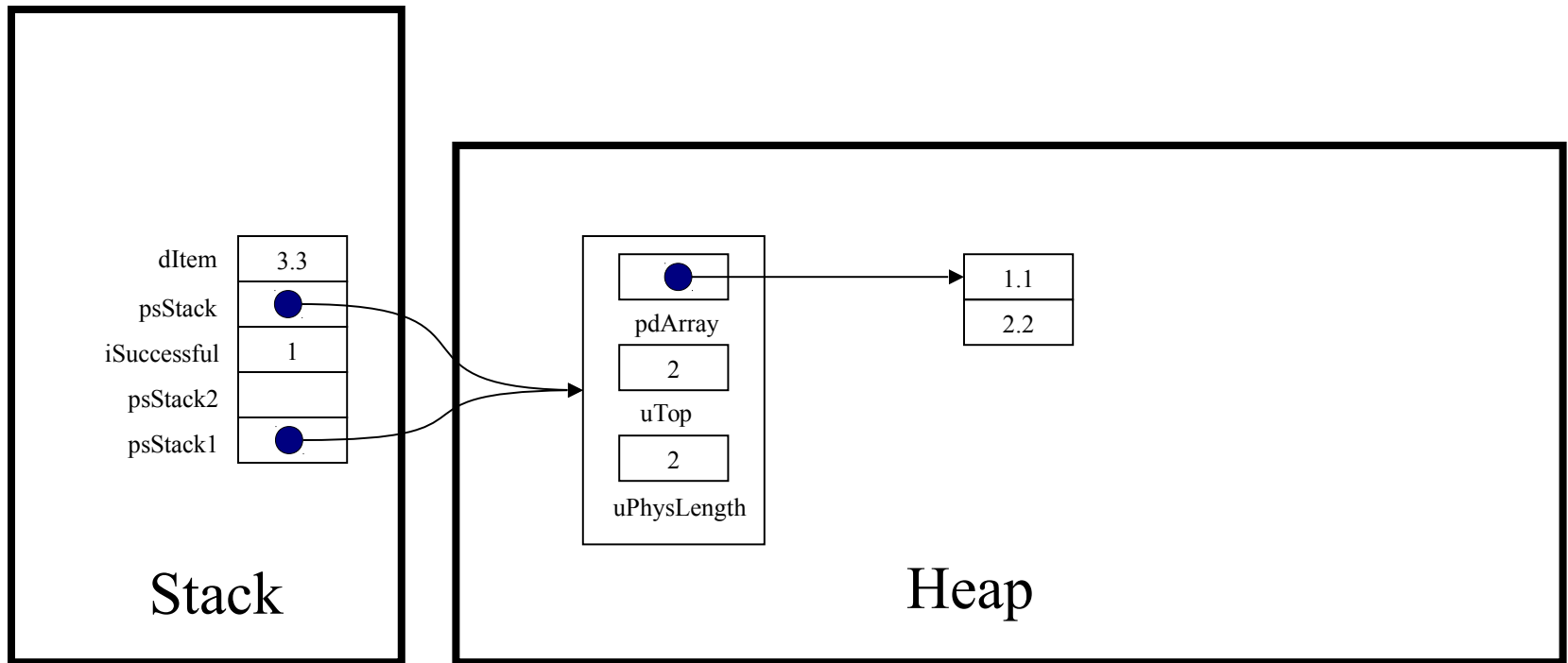

Princeton University
COS 217: Introduction to Programming Systems
Trace of teststack (Version 1)

```
int iSuccessful;
```

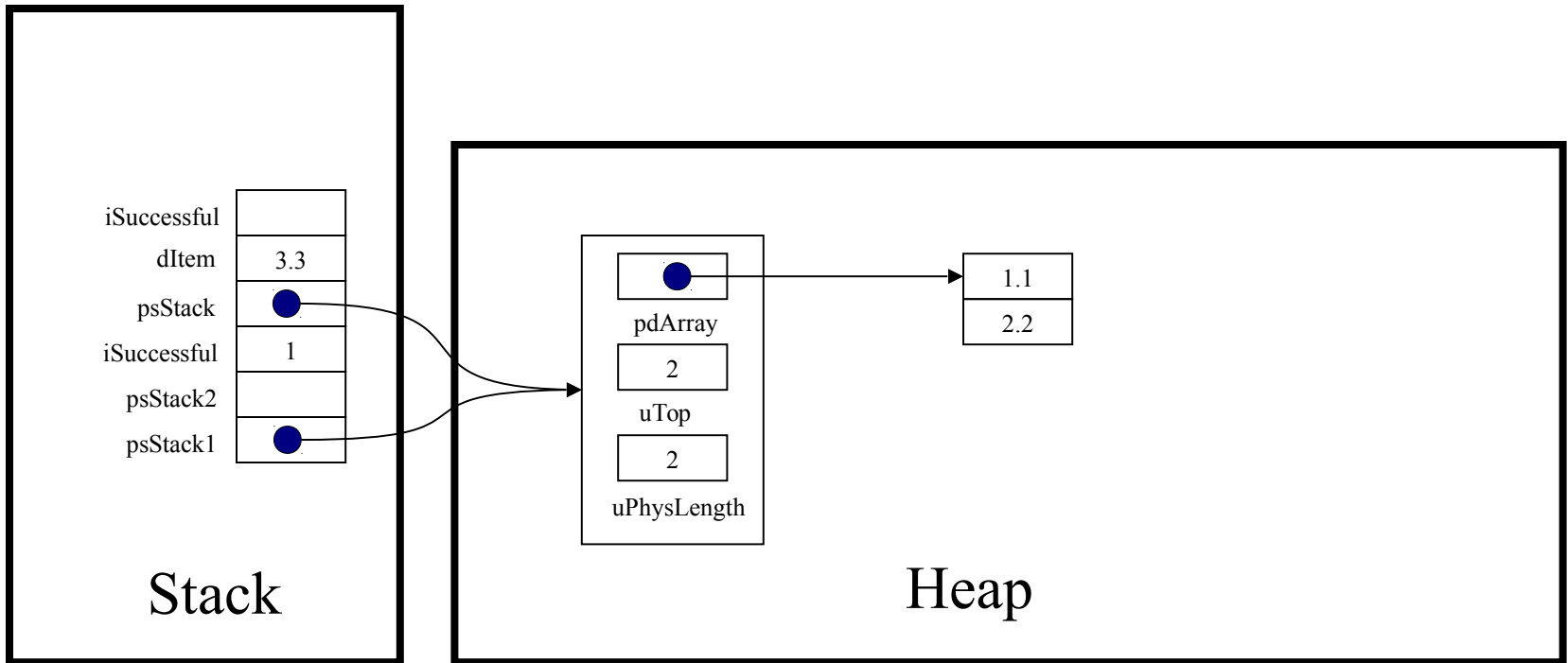

Princeton University
COS 217: Introduction to Programming Systems
Trace of teststack (Version 1)

```
assert (psStack != NULL);
```

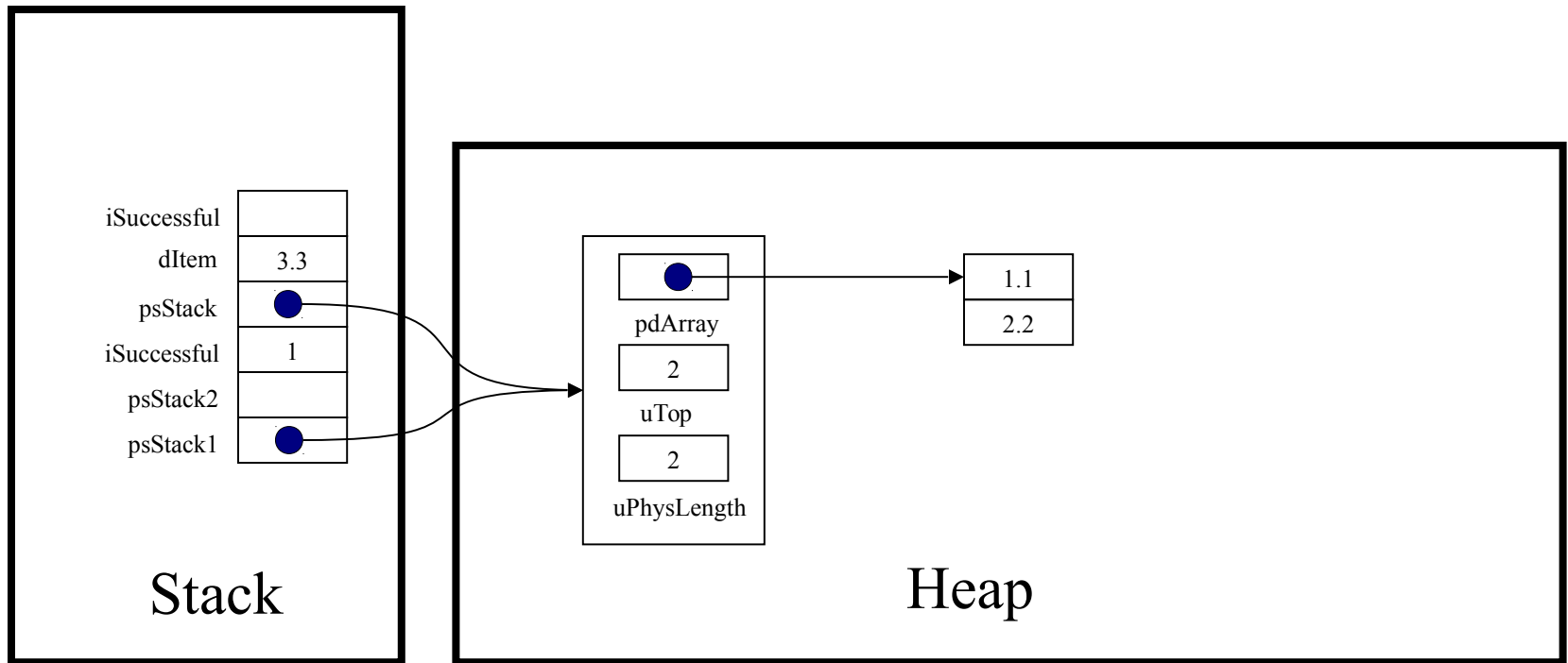

Princeton University
COS 217: Introduction to Programming Systems
Trace of teststack (Version 1)

```
if (psStack->uTop == psStack->uPhysLength)
```

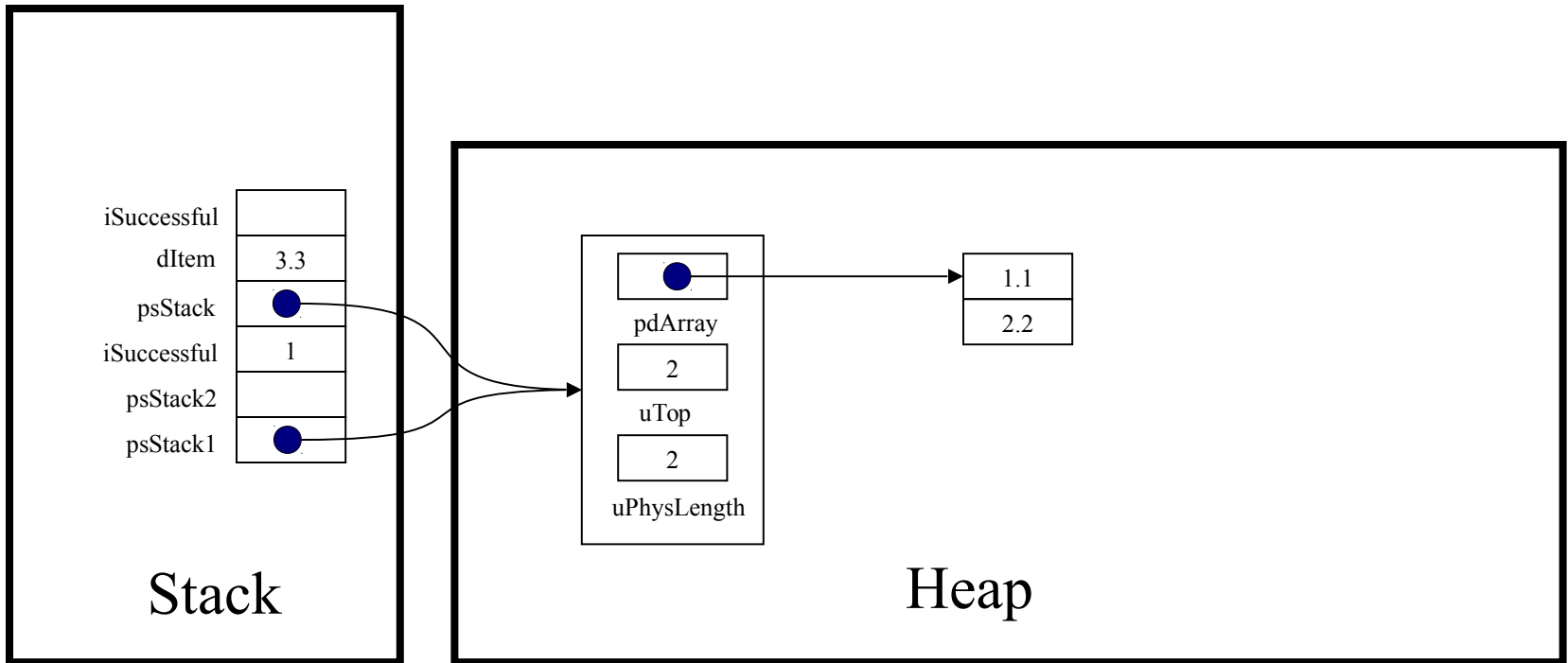

Princeton University
COS 217: Introduction to Programming Systems
Trace of teststack (Version 1)

```
iSuccessful = Stack_grow(psStack);
```

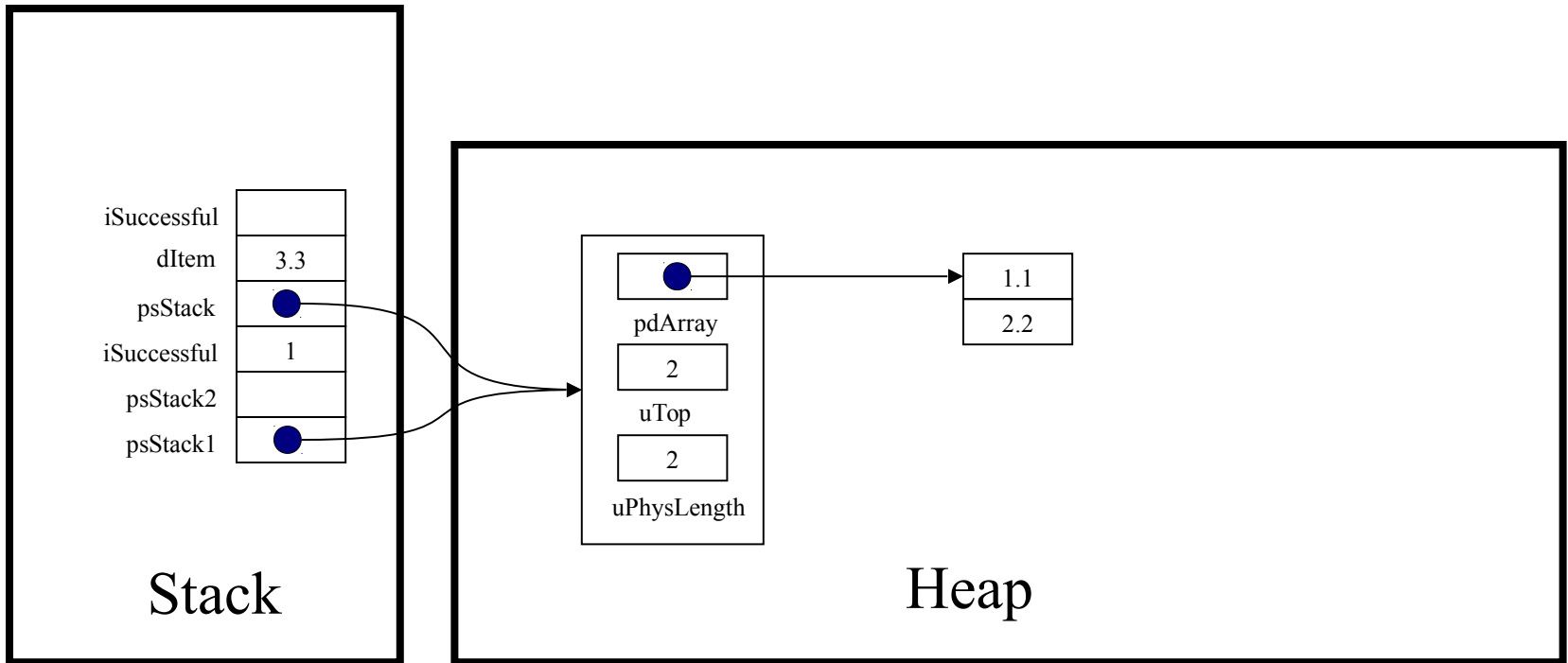

Princeton University
COS 217: Introduction to Programming Systems
Trace of teststack (Version 1)

```
static int Stack_grow(struct Stack *psStack)
```

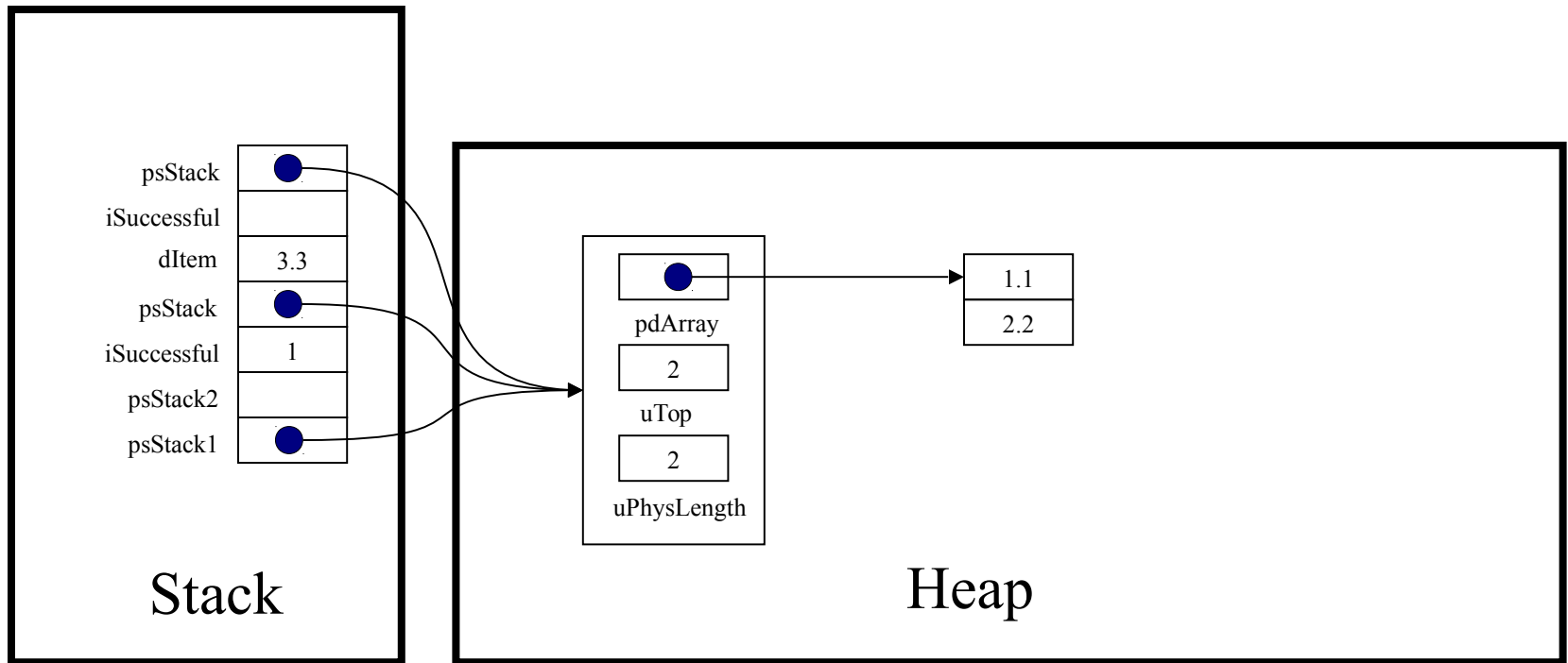

Princeton University
COS 217: Introduction to Programming Systems
Trace of teststack (Version 1)

```
size_t uNewPhysLength;
```

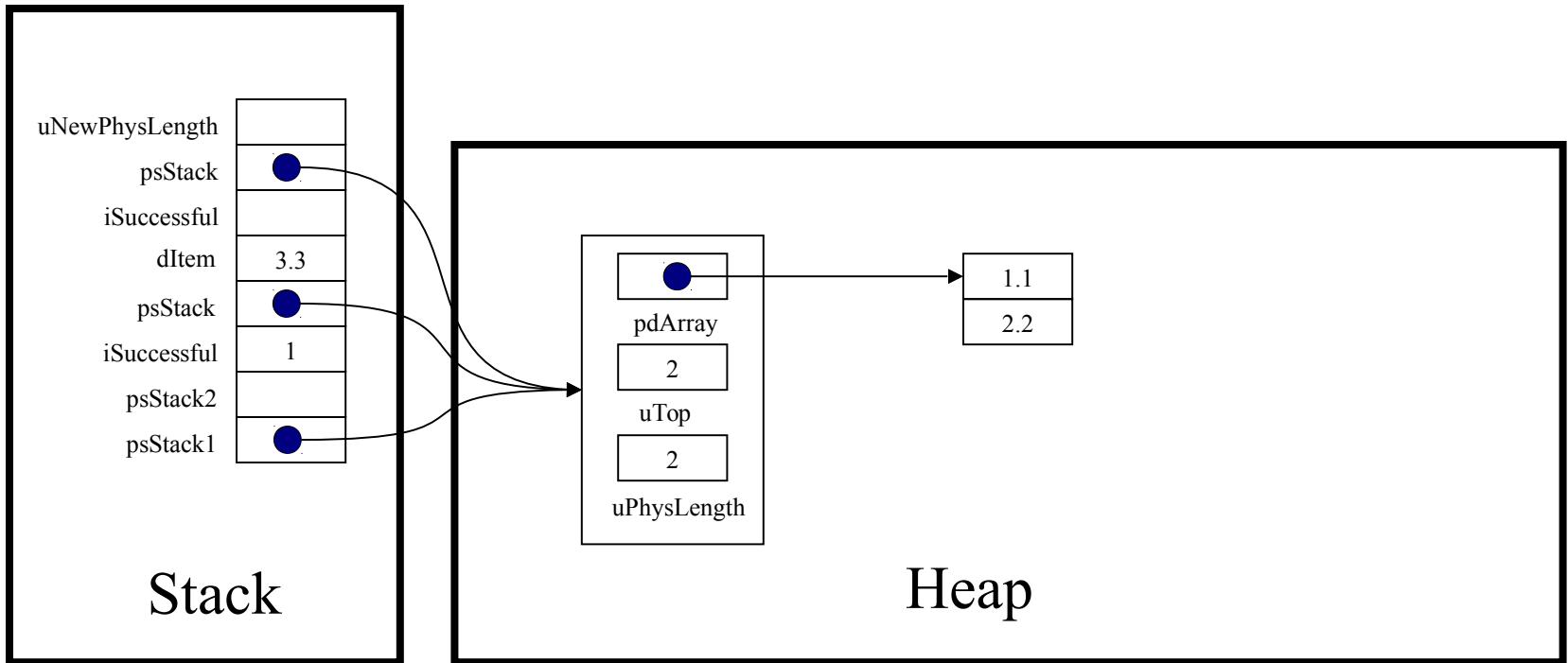

Princeton University
COS 217: Introduction to Programming Systems
Trace of teststack (Version 1)

```
double *pdNewArray;
```

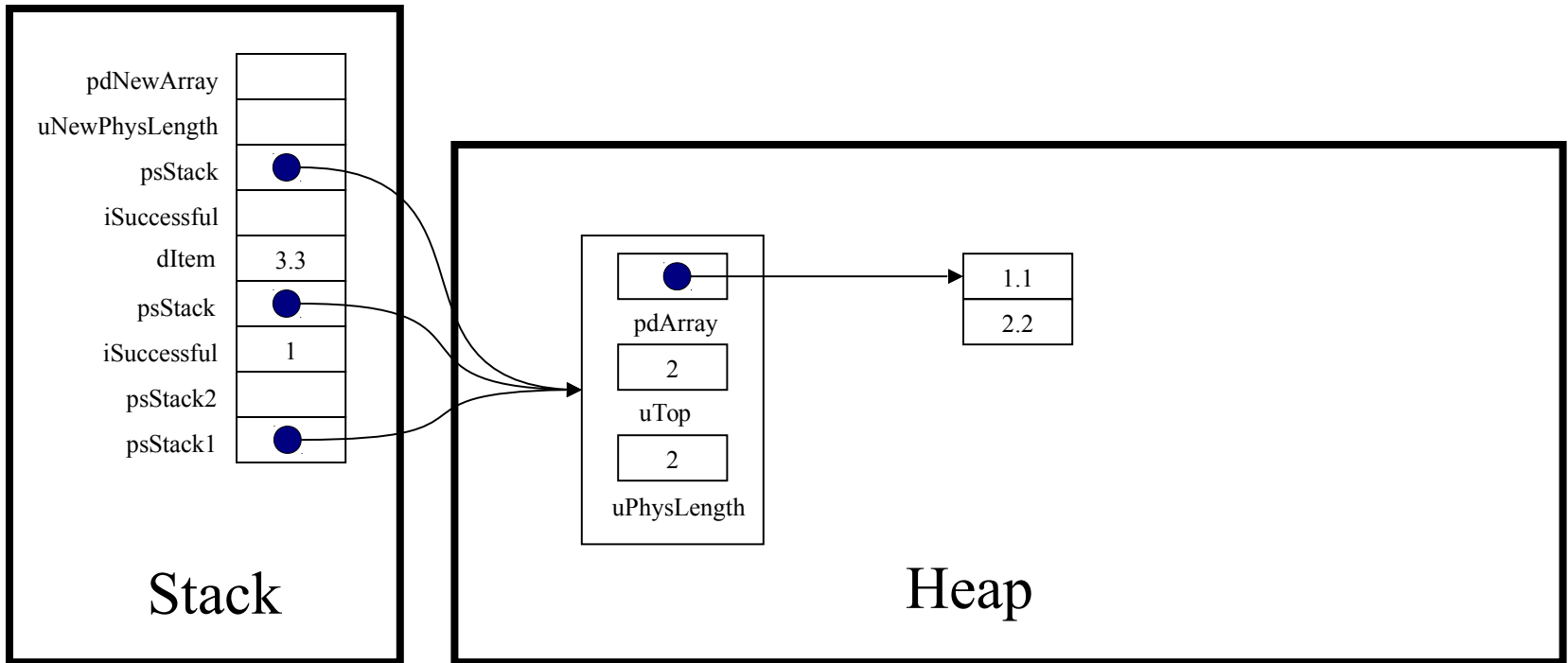

Princeton University
COS 217: Introduction to Programming Systems
Trace of teststack (Version 1)

```
assert (psStack != NULL);
```

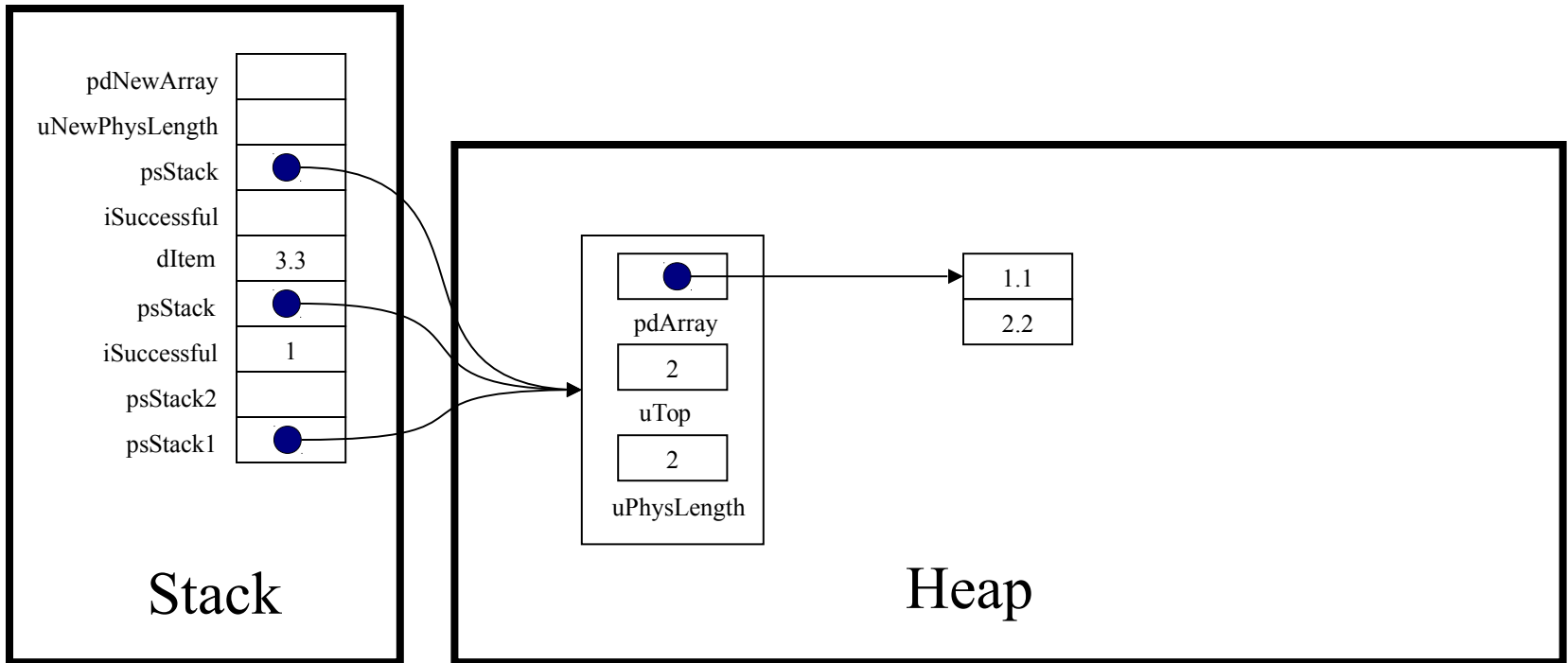

Princeton University
COS 217: Introduction to Programming Systems
Trace of teststack (Version 1)

```
uNewPhysLength = GROWTH_FACTOR * pcStack->uPhysLength;
```

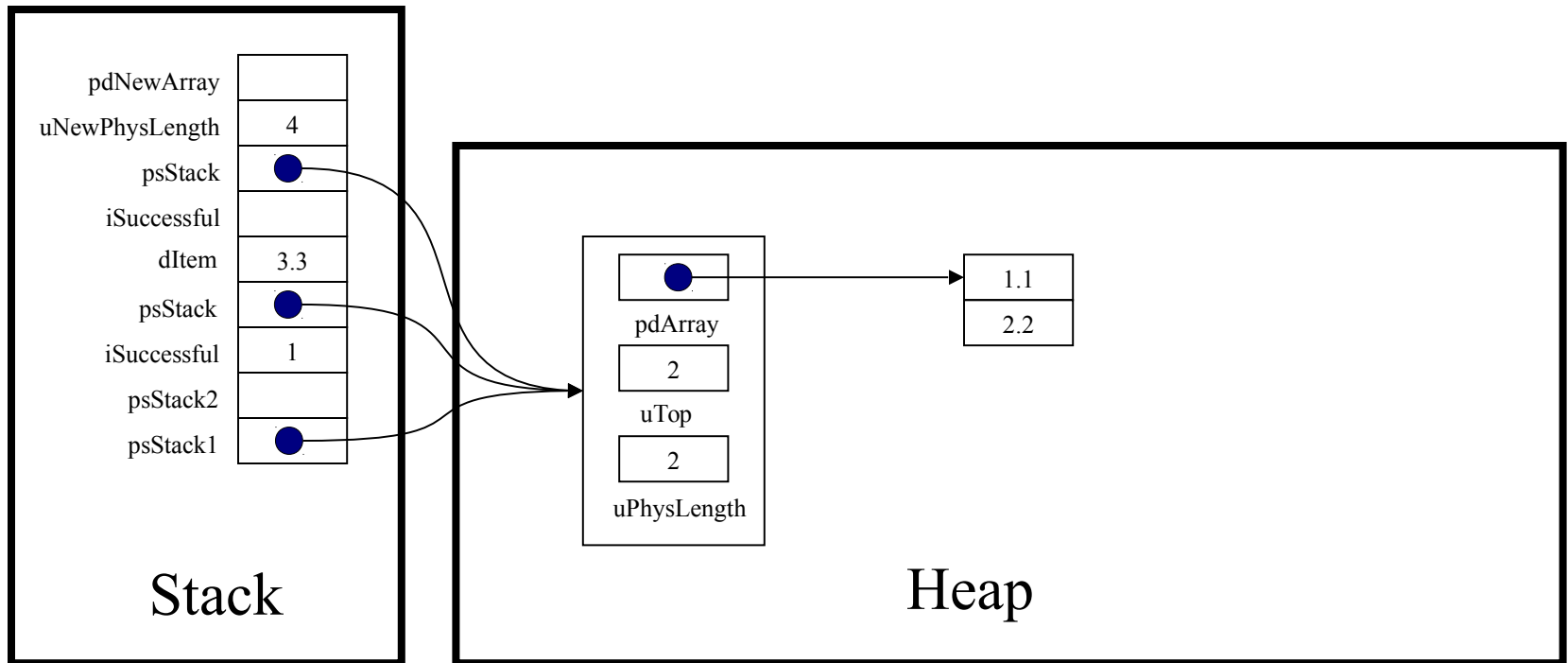

Princeton University
COS 217: Introduction to Programming Systems
Trace of teststack (Version 1)

```
pdNewArray = (double*)  
  realloc(psStack->pdArray, sizeof(double) * uNewPhysLength);
```

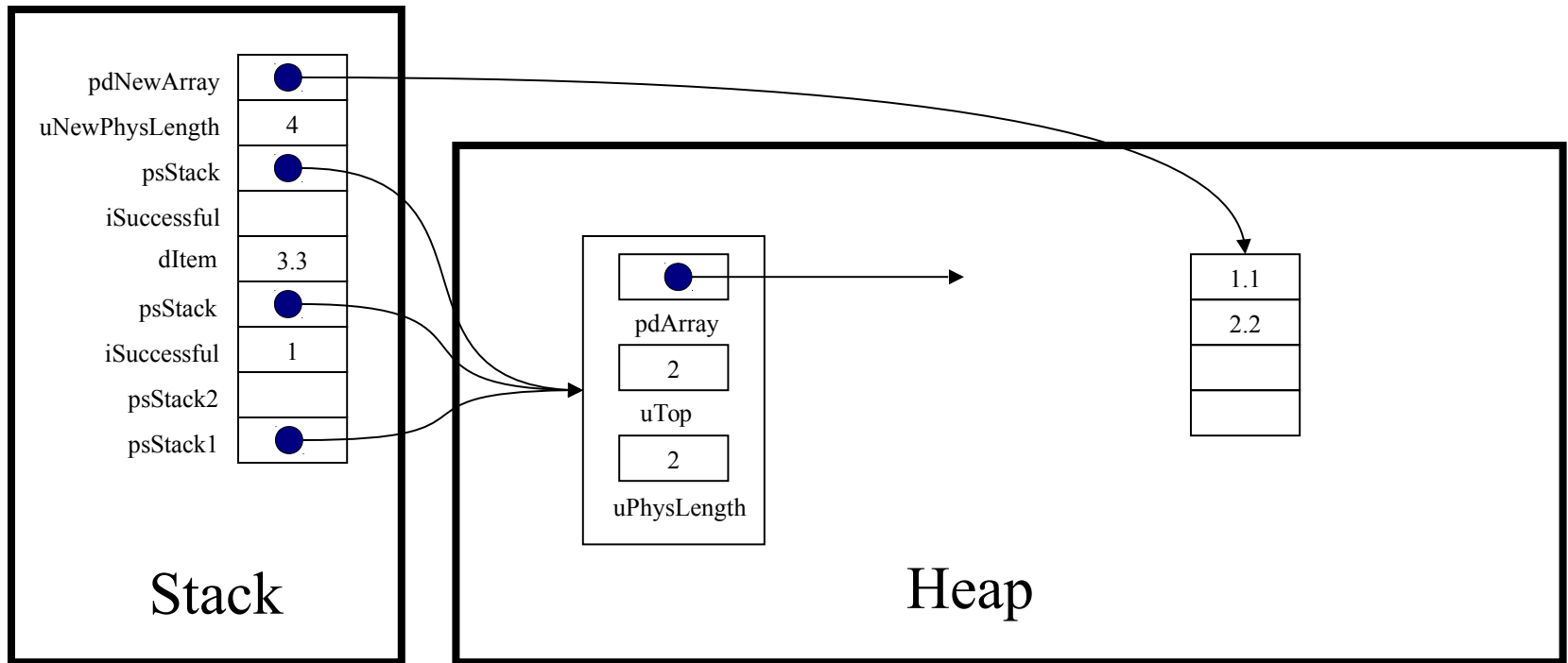

Princeton University
COS 217: Introduction to Programming Systems
Trace of teststack (Version 1)

```
if (pdNewArray == NULL)  
    return 0;
```

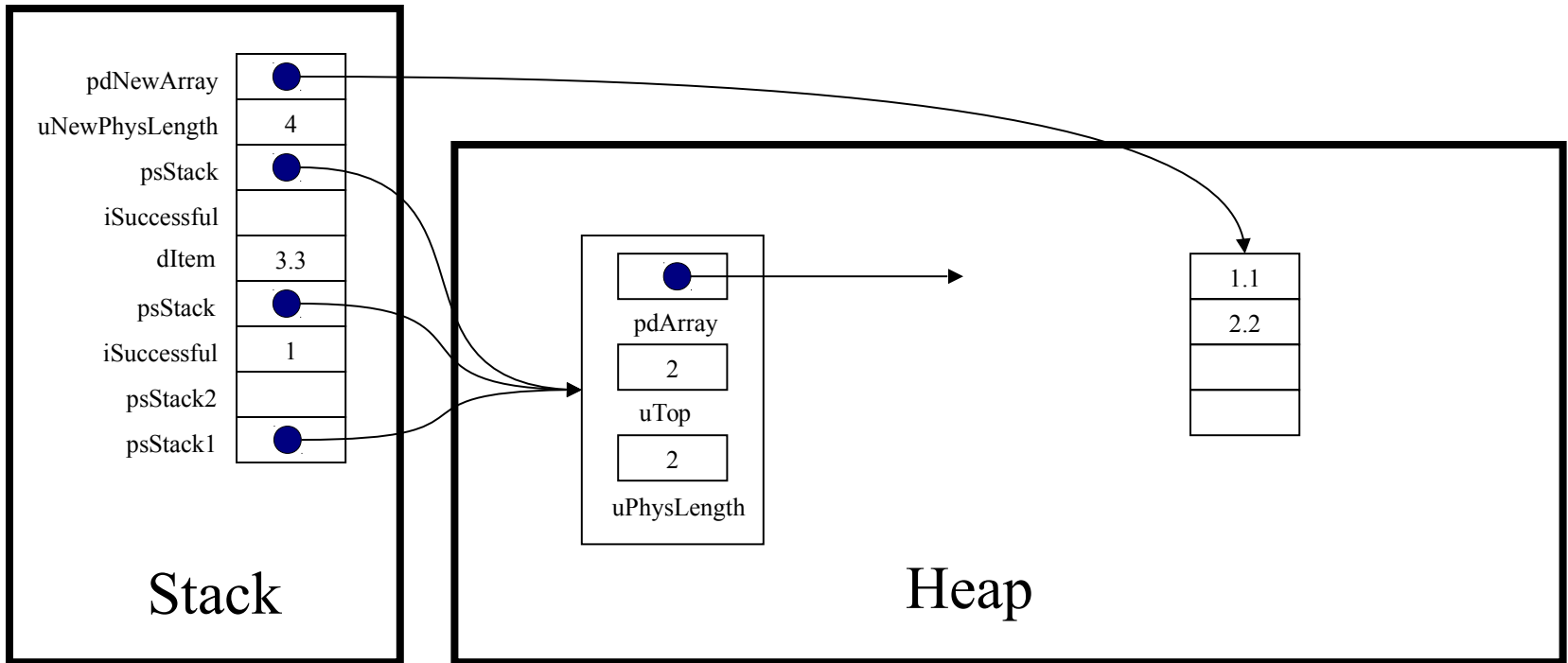

Princeton University
COS 217: Introduction to Programming Systems
Trace of teststack (Version 1)

```
psStack->uPhysLength = uNewPhysLength;
```

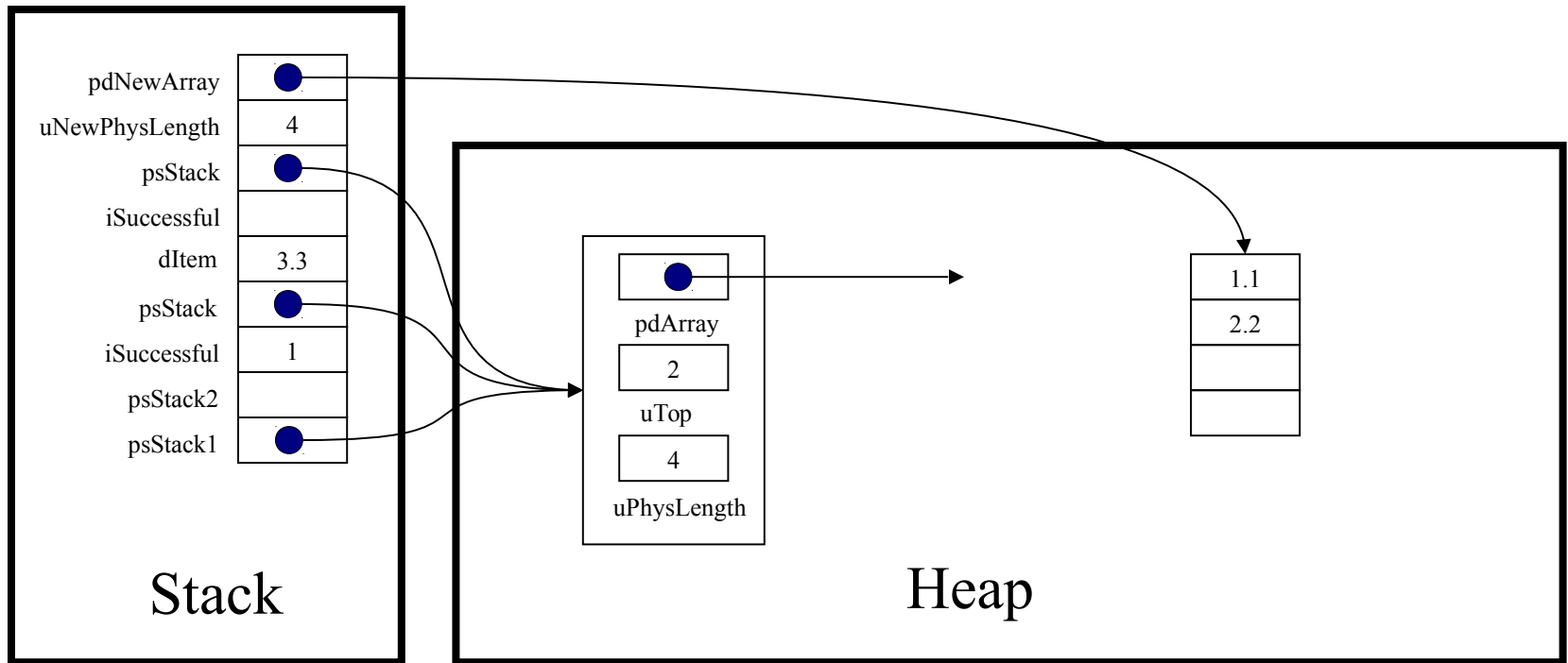

Princeton University
COS 217: Introduction to Programming Systems
Trace of teststack (Version 1)

```
psStack->pdArray = pdNewArray;
```

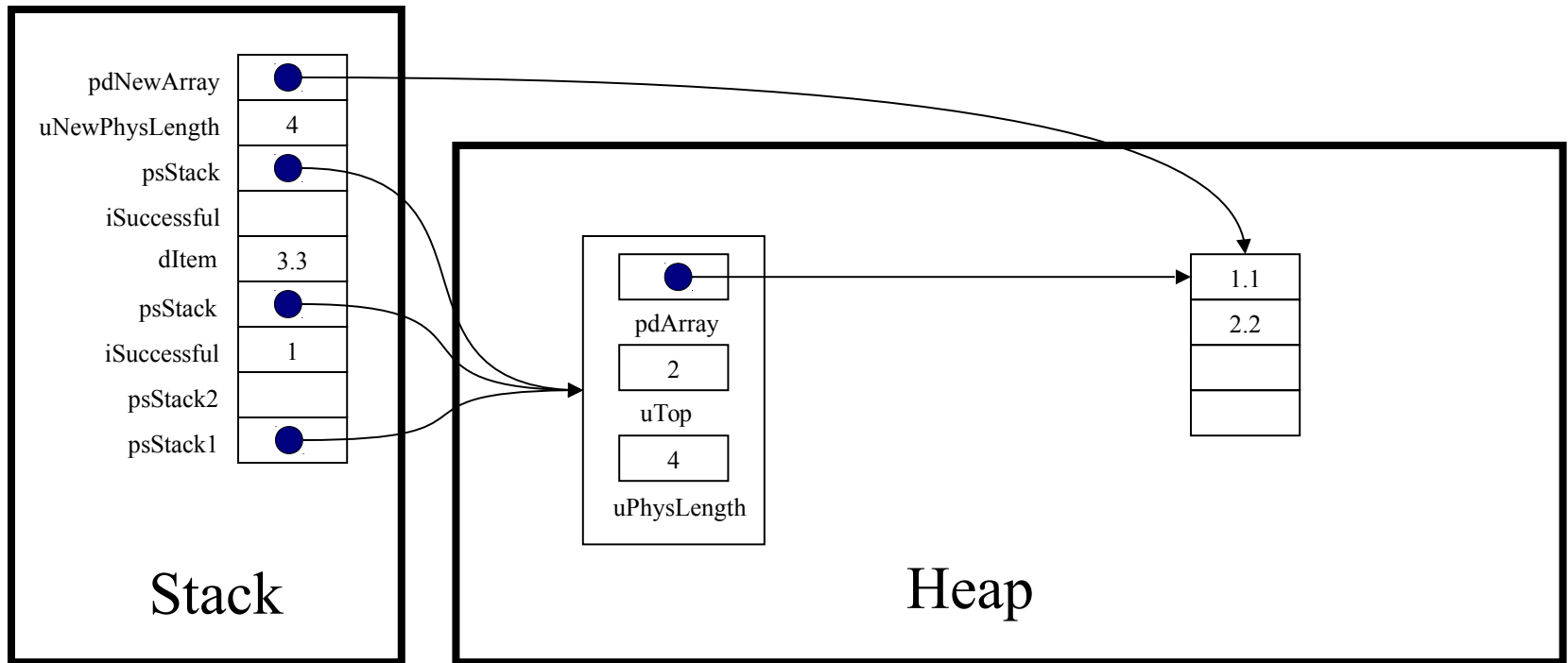

Princeton University
COS 217: Introduction to Programming Systems
Trace of teststack (Version 1)

```
return 1;
```

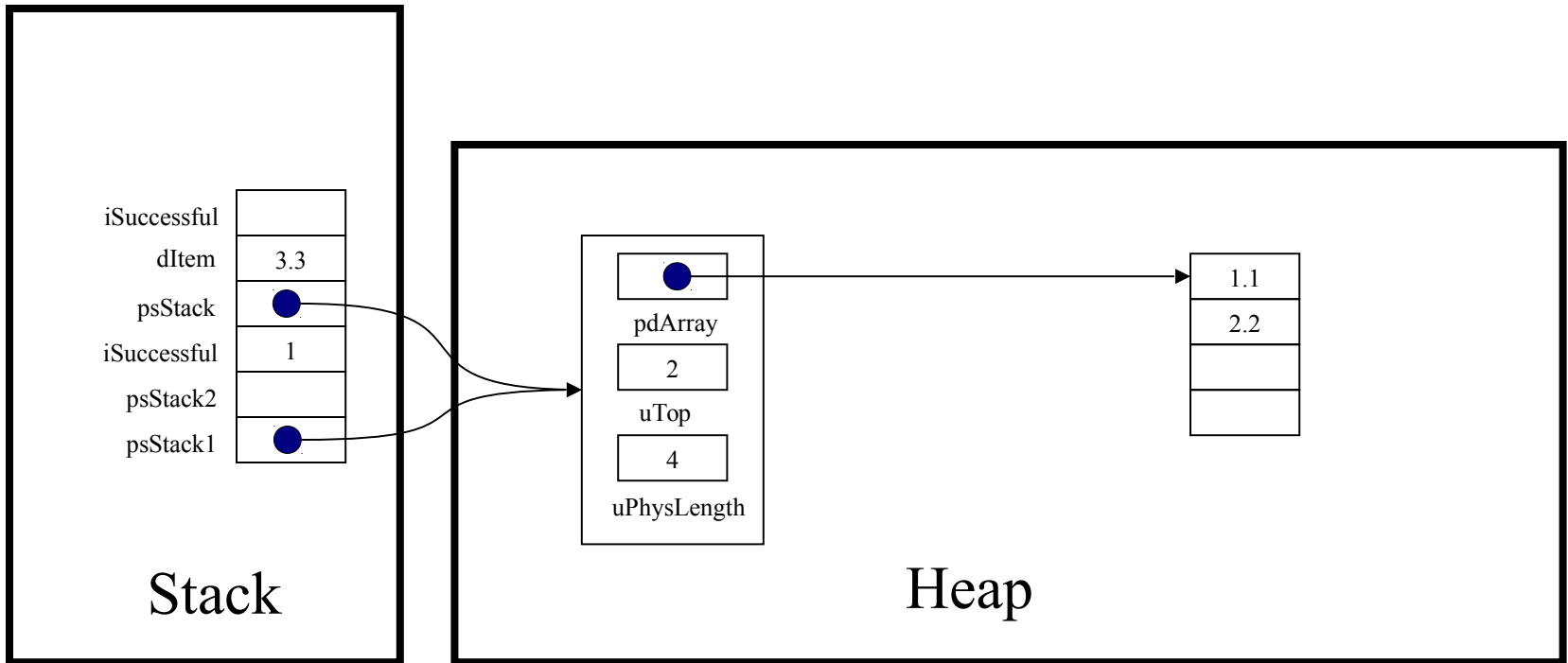

Princeton University
COS 217: Introduction to Programming Systems
Trace of teststack (Version 1)

```
iSuccessful = Stack_grow(psStack);
```

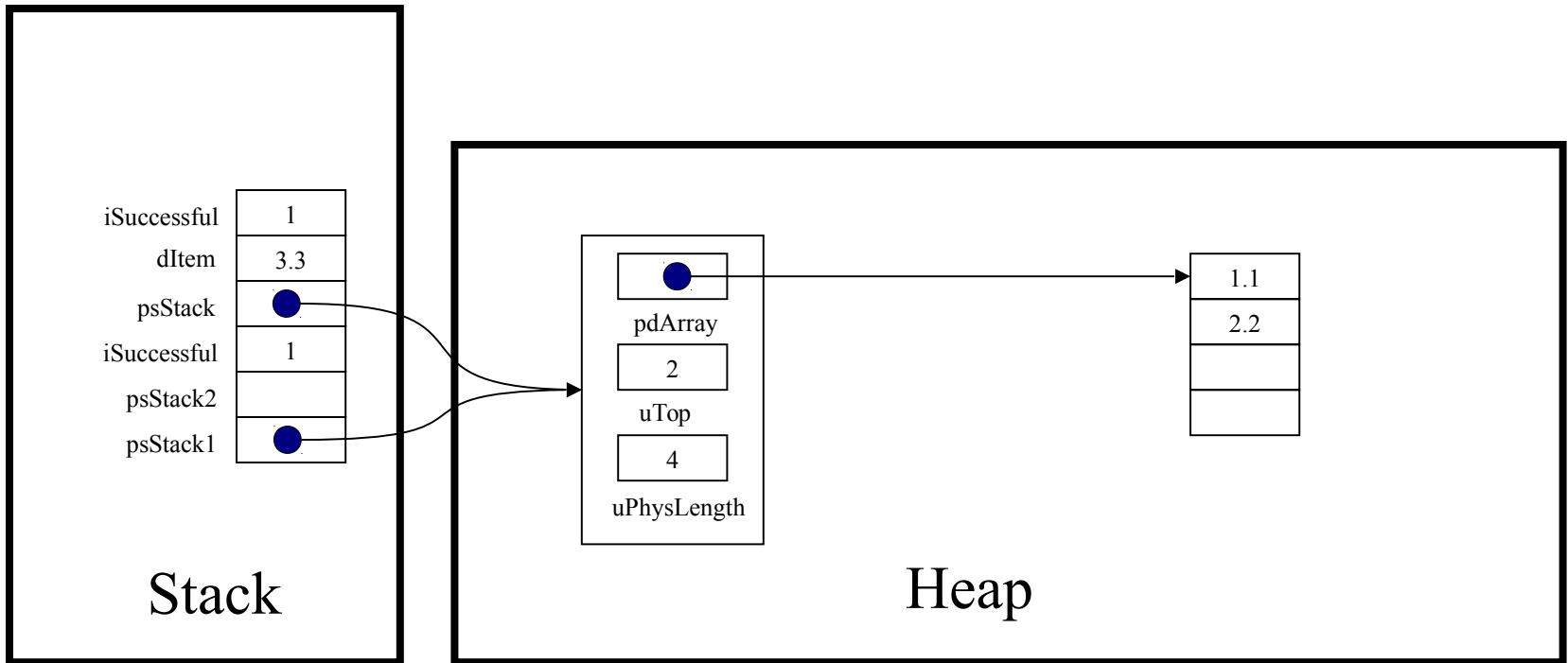

Princeton University
COS 217: Introduction to Programming Systems
Trace of teststack (Version 1)

```
if (! iSuccessful)  
    return 0;
```

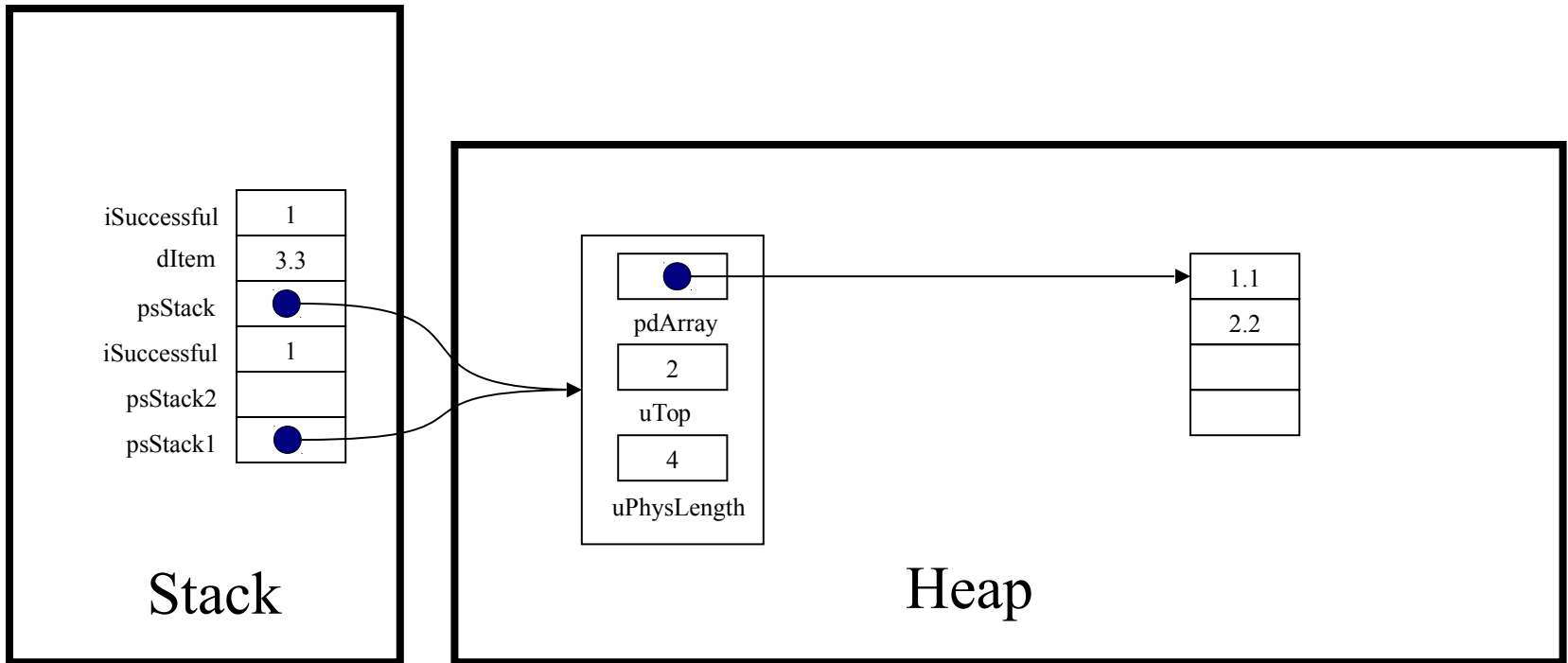

Princeton University
COS 217: Introduction to Programming Systems
Trace of teststack (Version 1)

```
(psStack->pdArray)[psStack->uTop] = dItem;
```

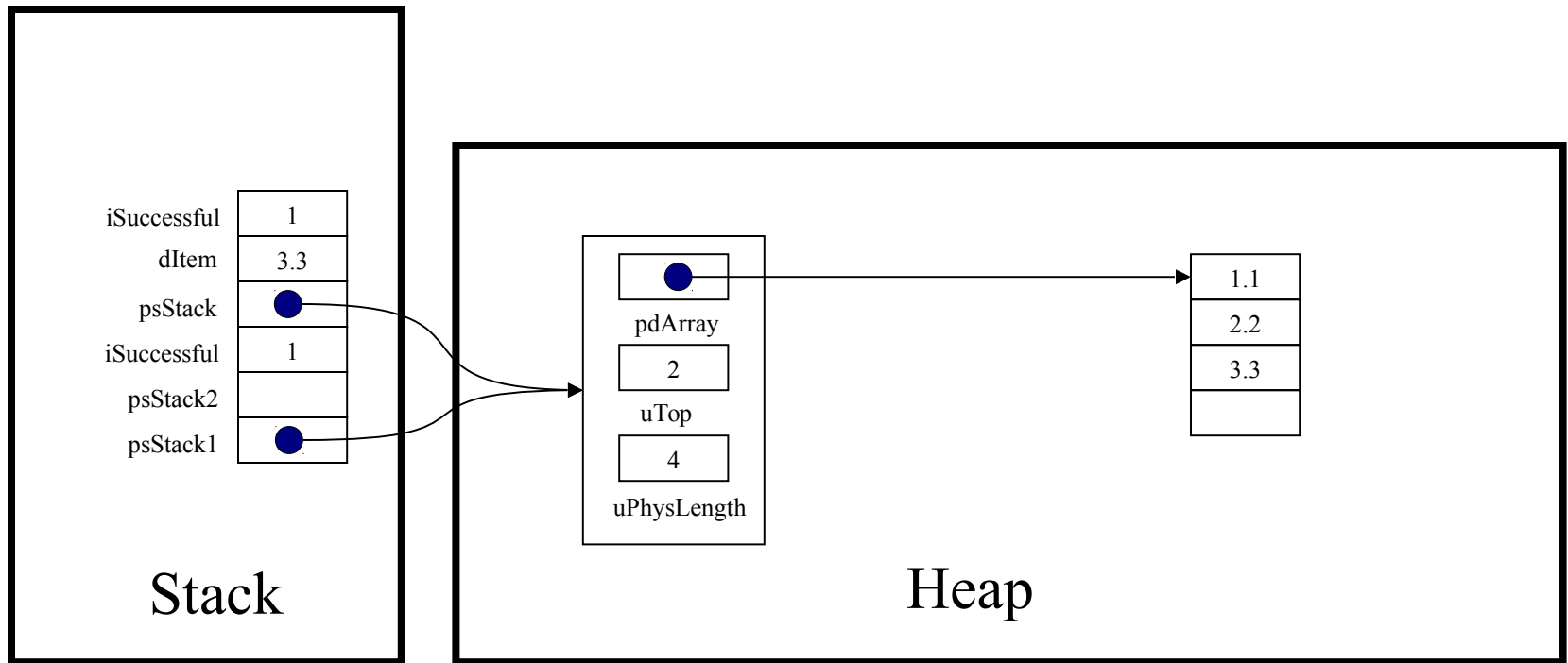

Princeton University
COS 217: Introduction to Programming Systems
Trace of teststack (Version 1)

```
(psStack->uTop) ++;
```

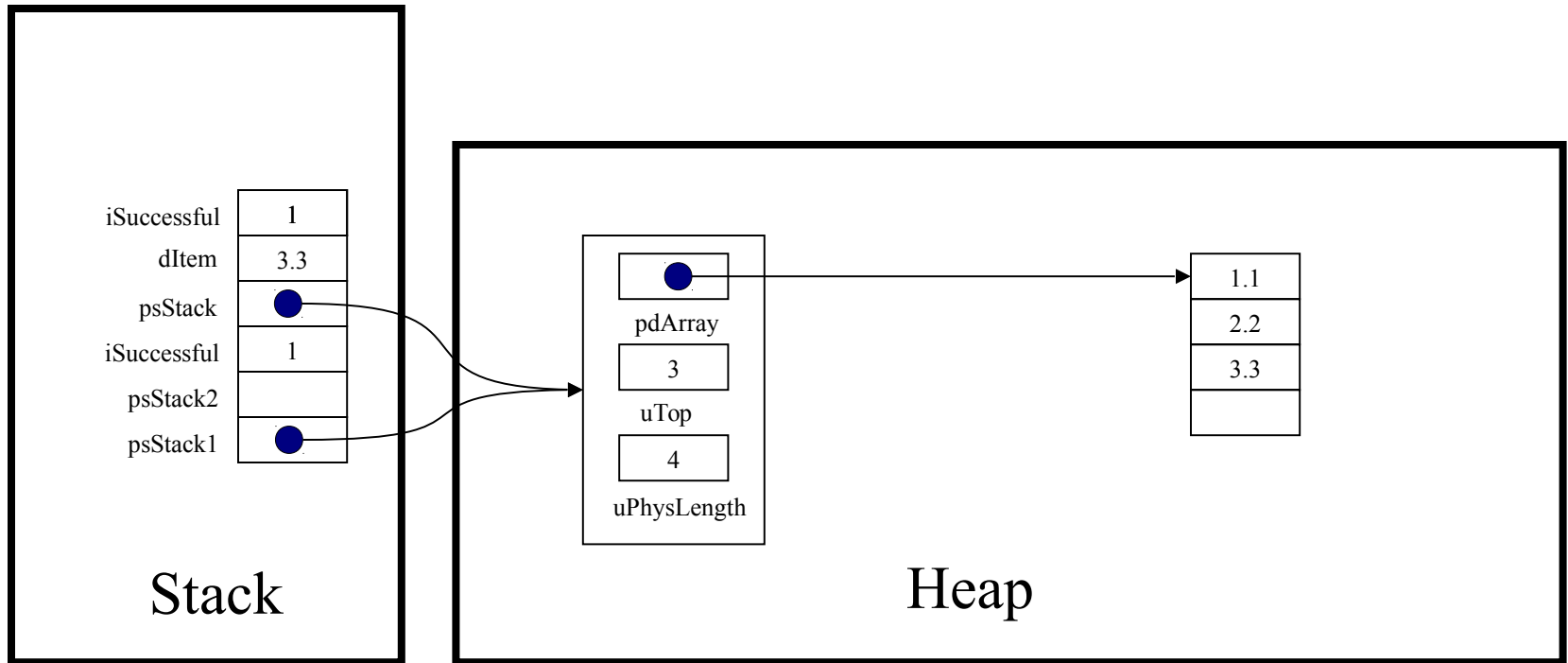

Princeton University
COS 217: Introduction to Programming Systems
Trace of teststack (Version 1)

```
return 1;
```

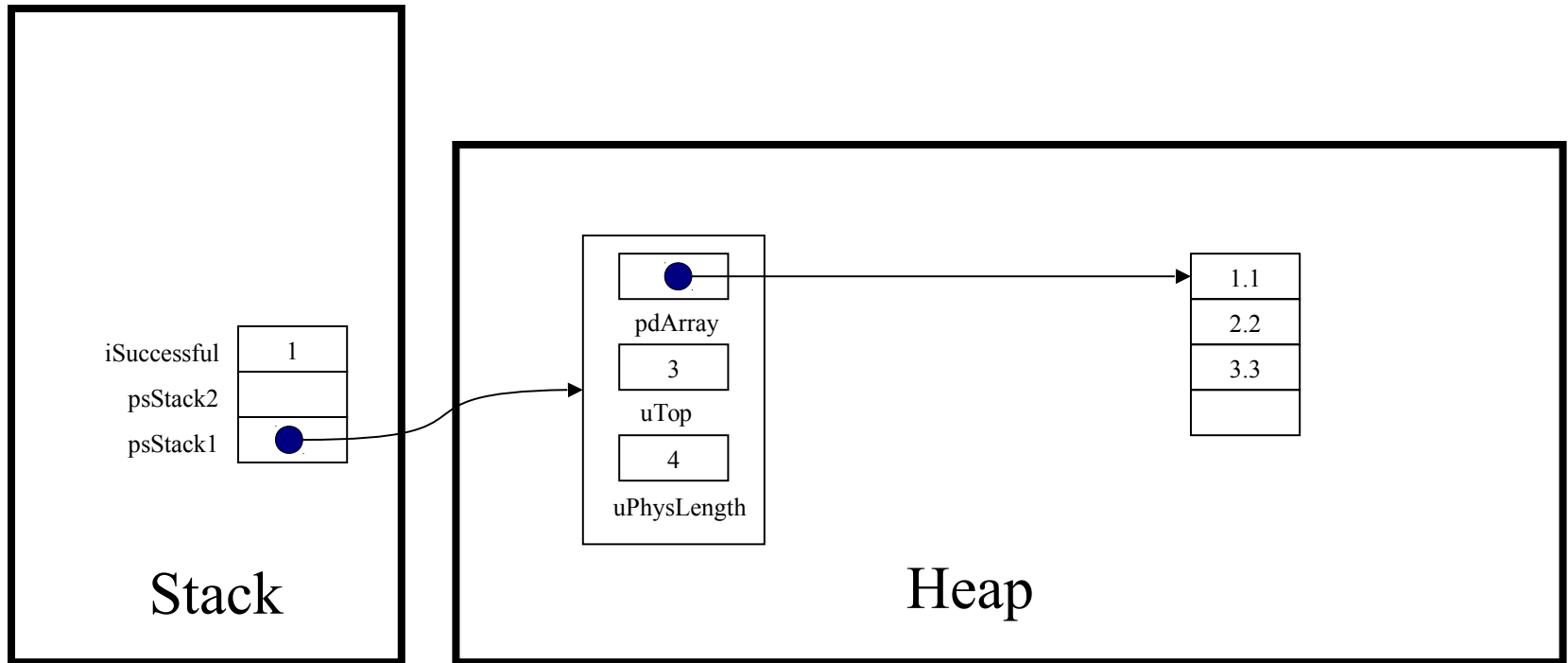

Princeton University
COS 217: Introduction to Programming Systems
Trace of teststack (Version 1)

```
iSuccessful = Stack_push(psStack1, 3.3);
```

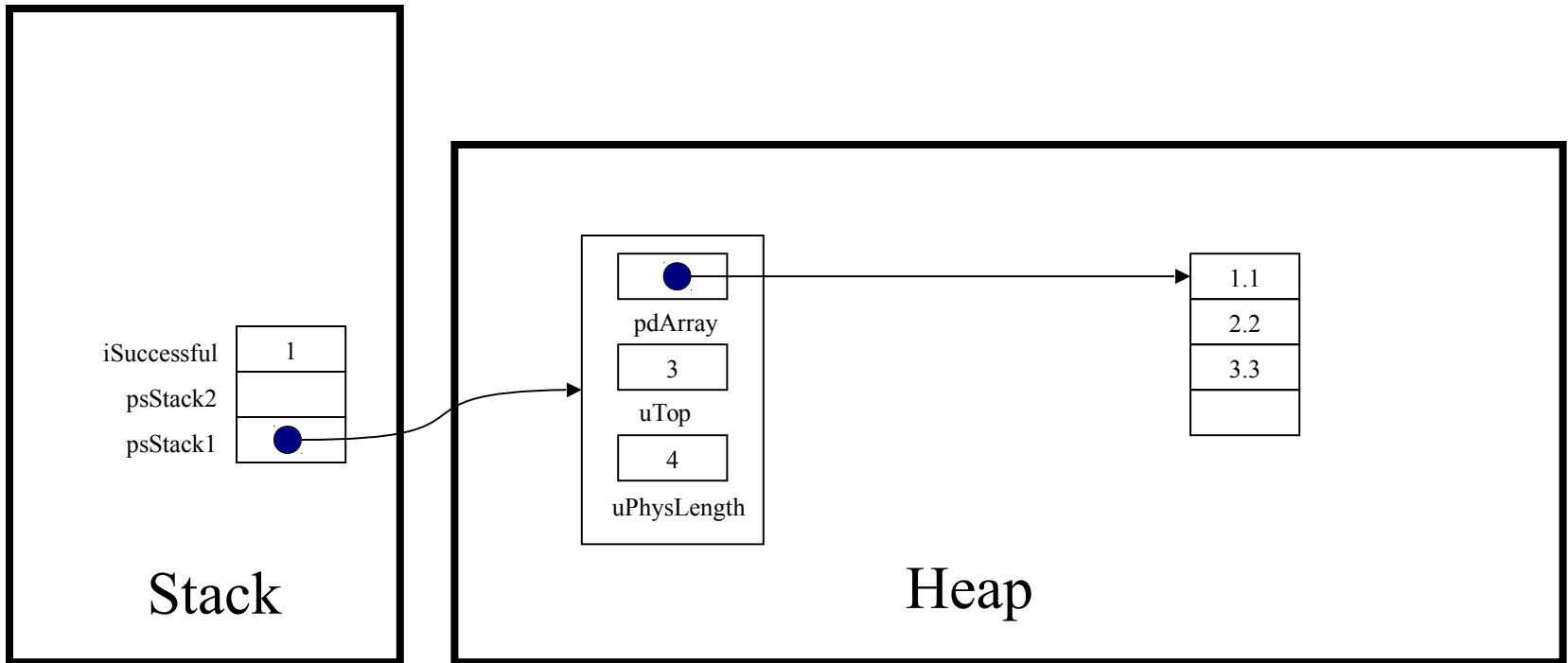

Princeton University
COS 217: Introduction to Programming Systems
Trace of teststack (Version 1)

```
if (! iSuccessful) handleMemoryError();
```

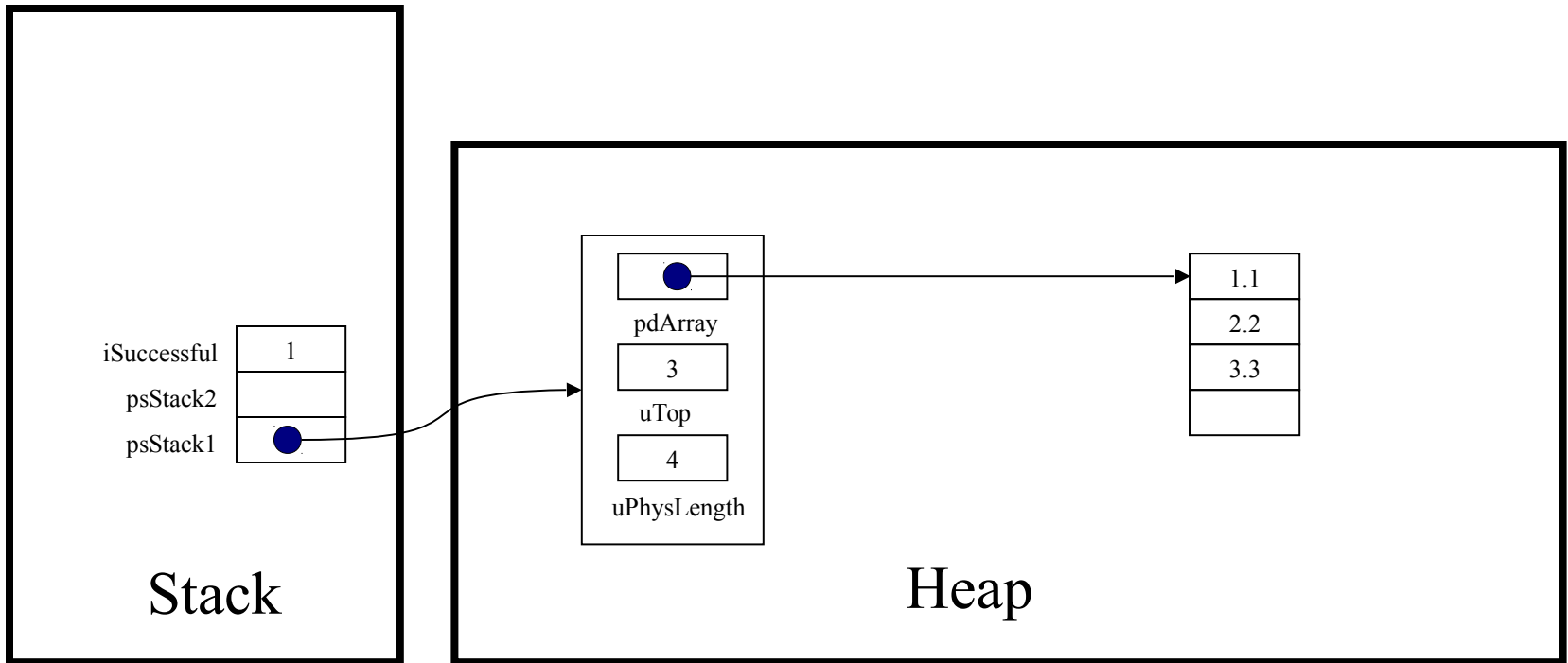

Princeton University
COS 217: Introduction to Programming Systems
Trace of teststack (Version 1)

```
while (! Stack_isEmpty(psStack1))  
    ...
```

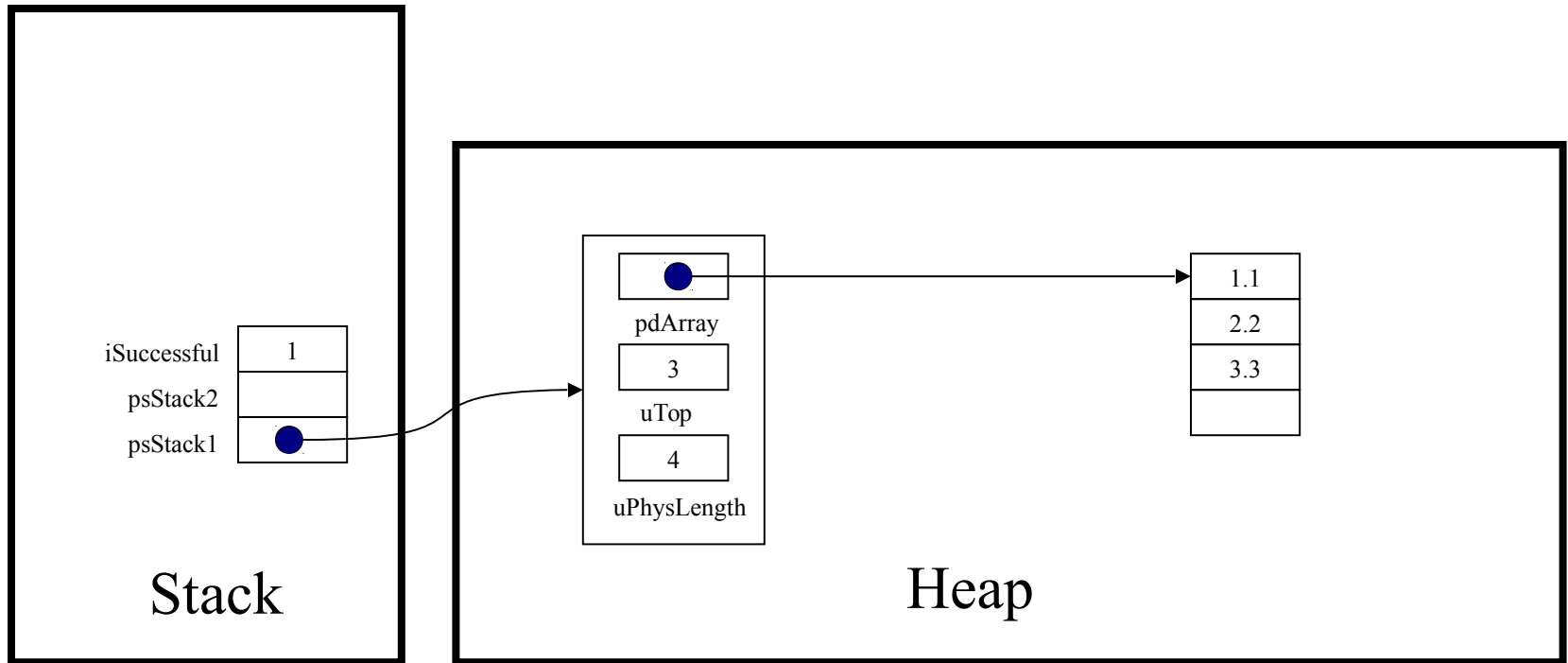

Princeton University
COS 217: Introduction to Programming Systems
Trace of teststack (Version 1)

```
int Stack_isEmpty(struct Stack *psStack)
```

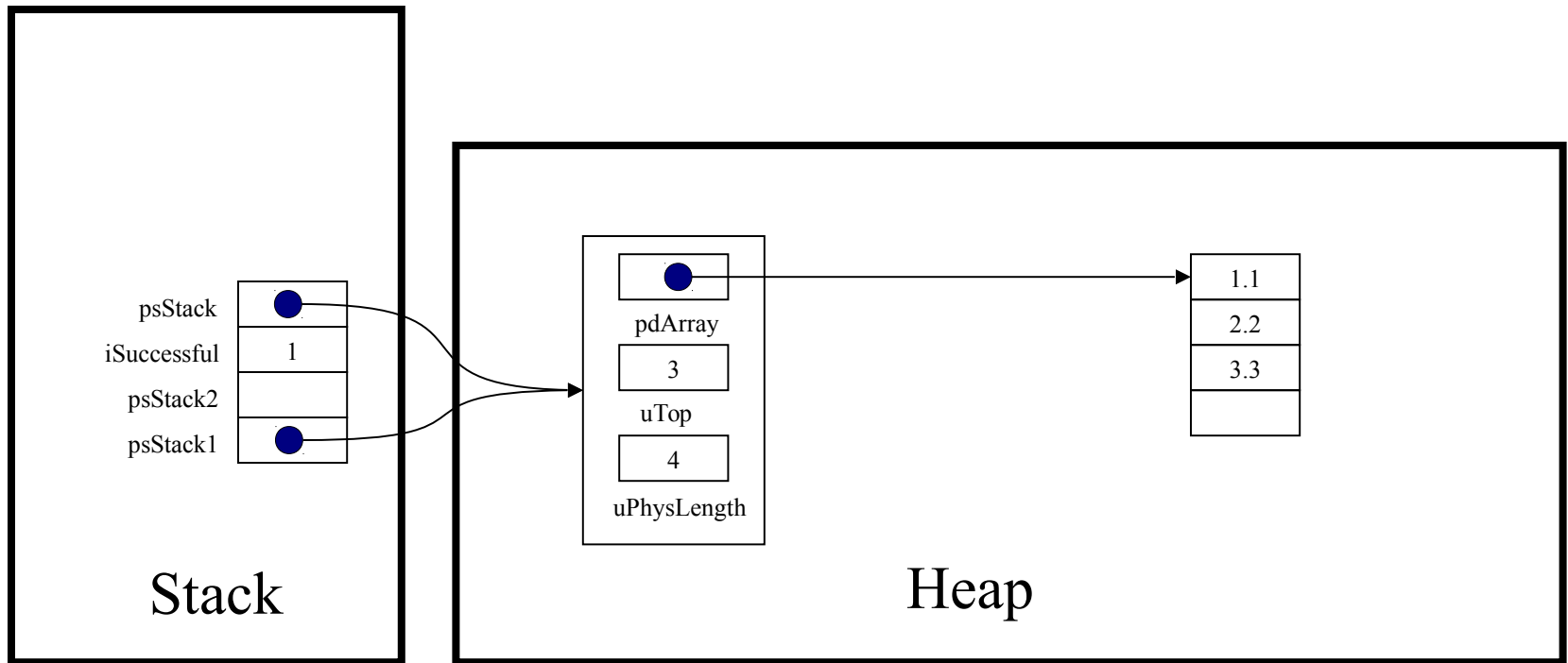

Princeton University
COS 217: Introduction to Programming Systems
Trace of teststack (Version 1)

```
assert (psStack != NULL);
```

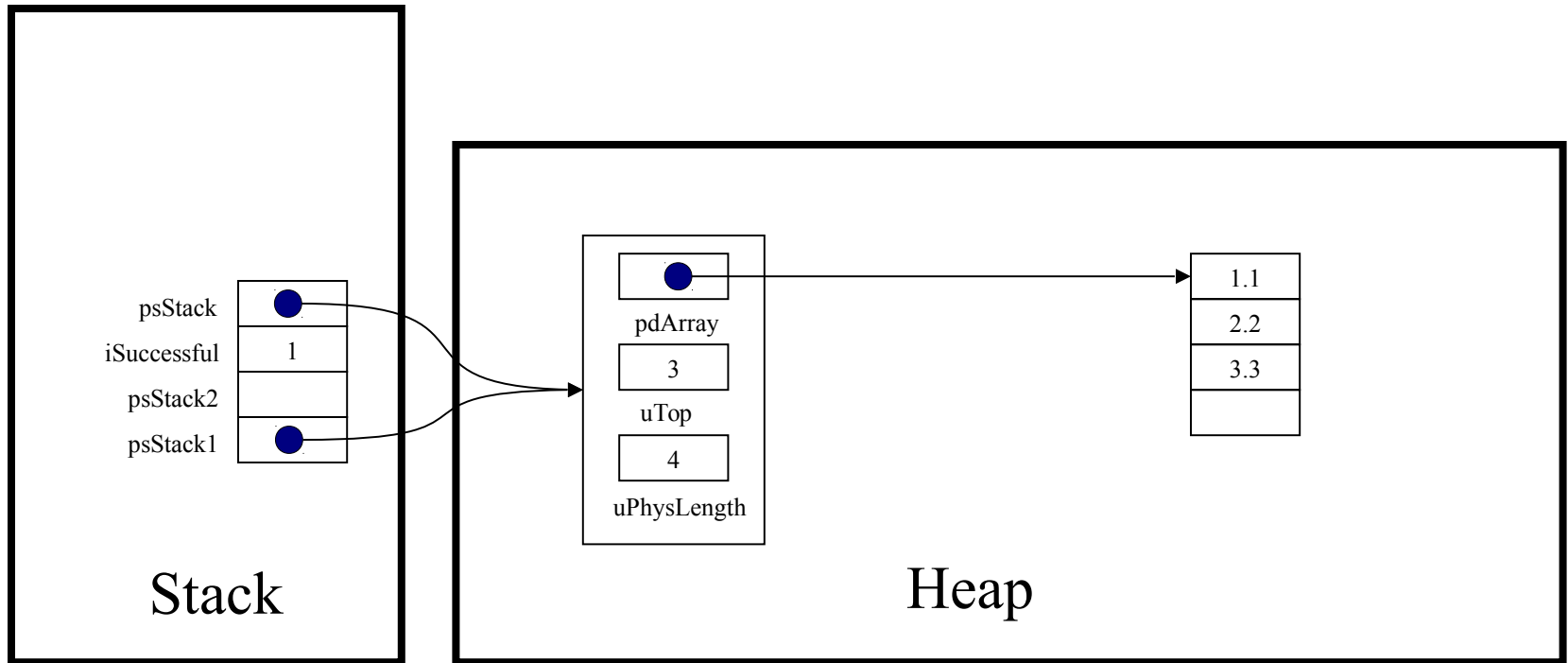

Princeton University
COS 217: Introduction to Programming Systems
Trace of teststack (Version 1)

```
return psStack->uTop == 0;
```

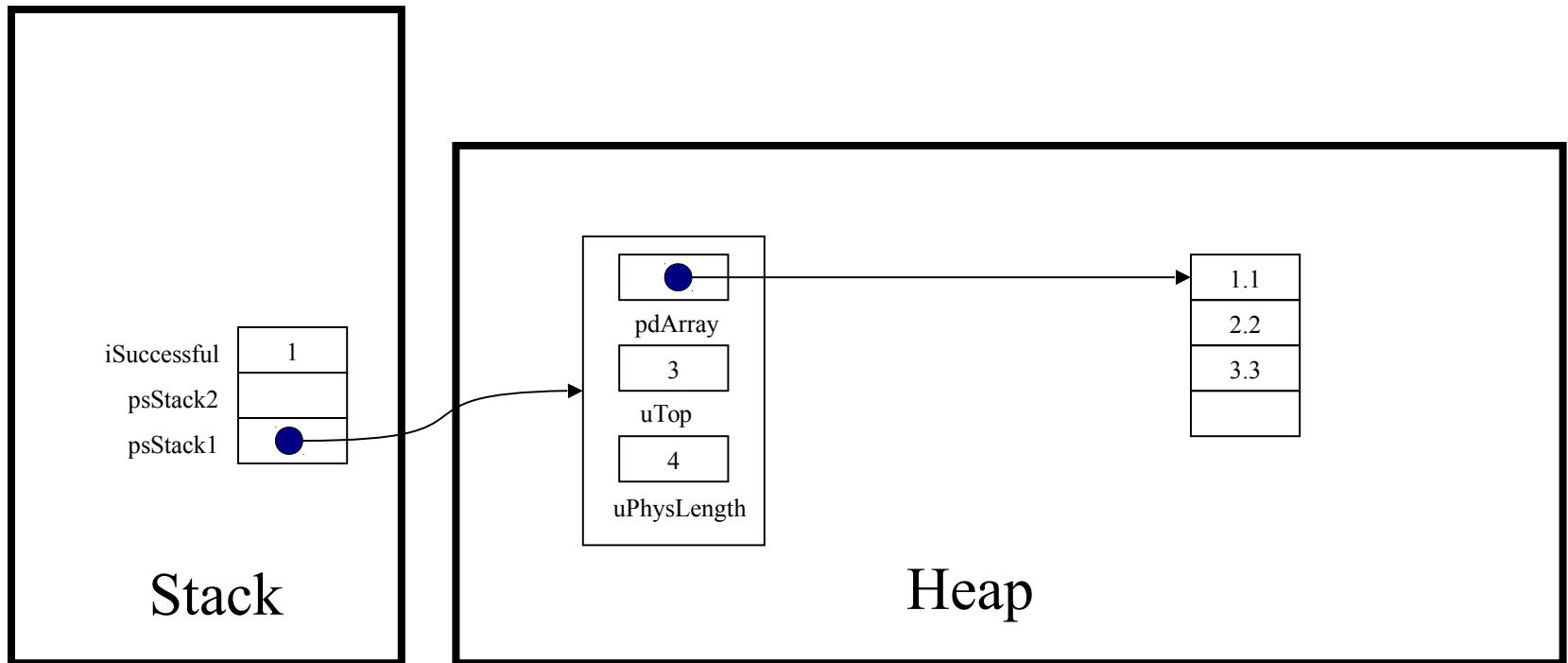

Princeton University
COS 217: Introduction to Programming Systems
Trace of teststack (Version 1)

```
while (! Stack_isEmpty(psStack1))
```

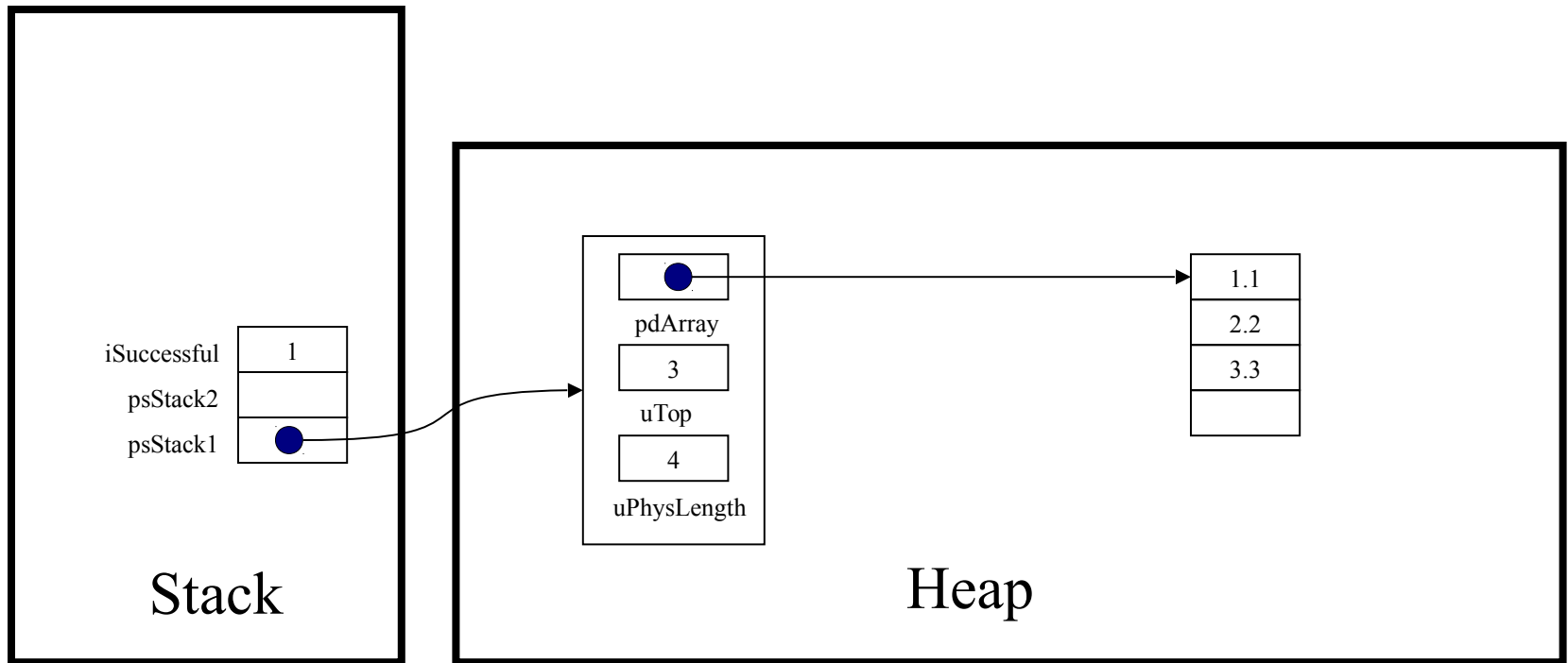

Princeton University
COS 217: Introduction to Programming Systems
Trace of teststack (Version 1)

```
printf("%g\n", Stack_pop(psStack1));
```

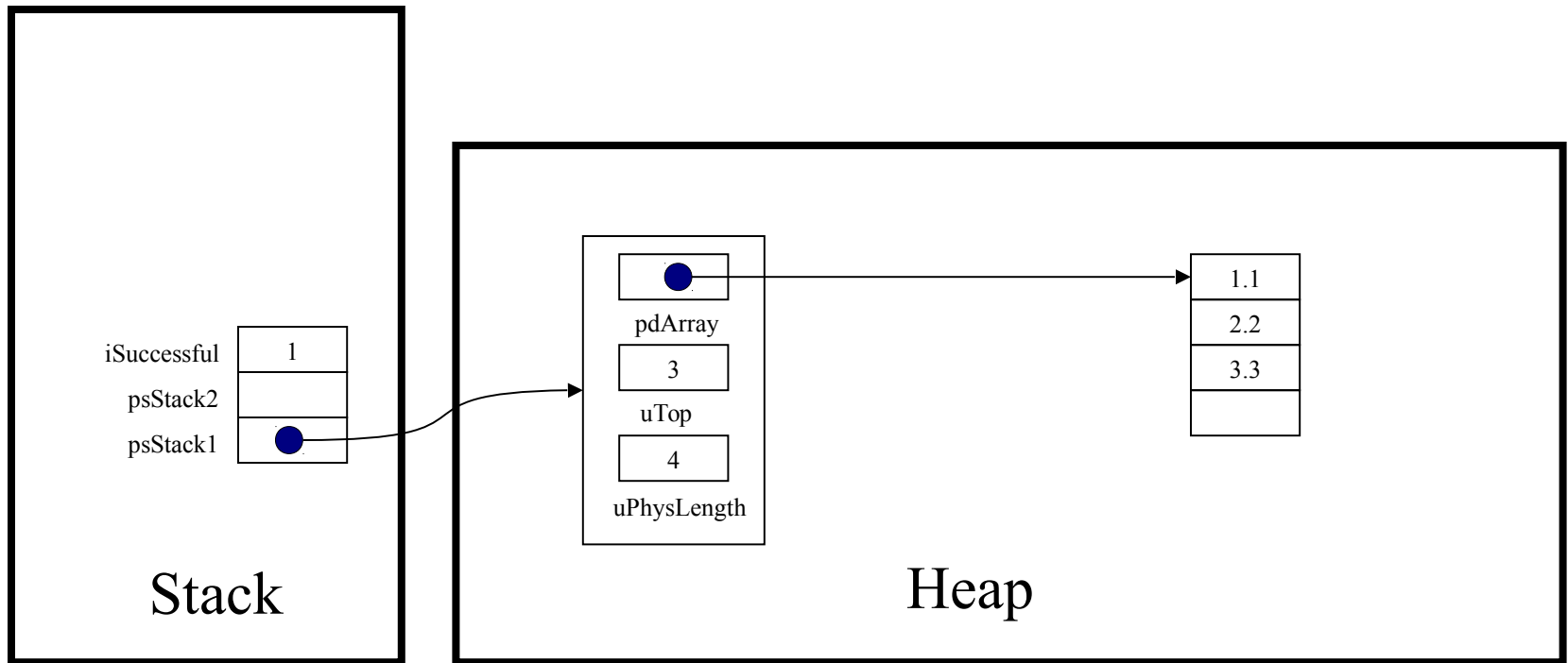

Princeton University
COS 217: Introduction to Programming Systems
Trace of teststack (Version 1)

```
double Stack_pop(struct Stack *psStack)
```

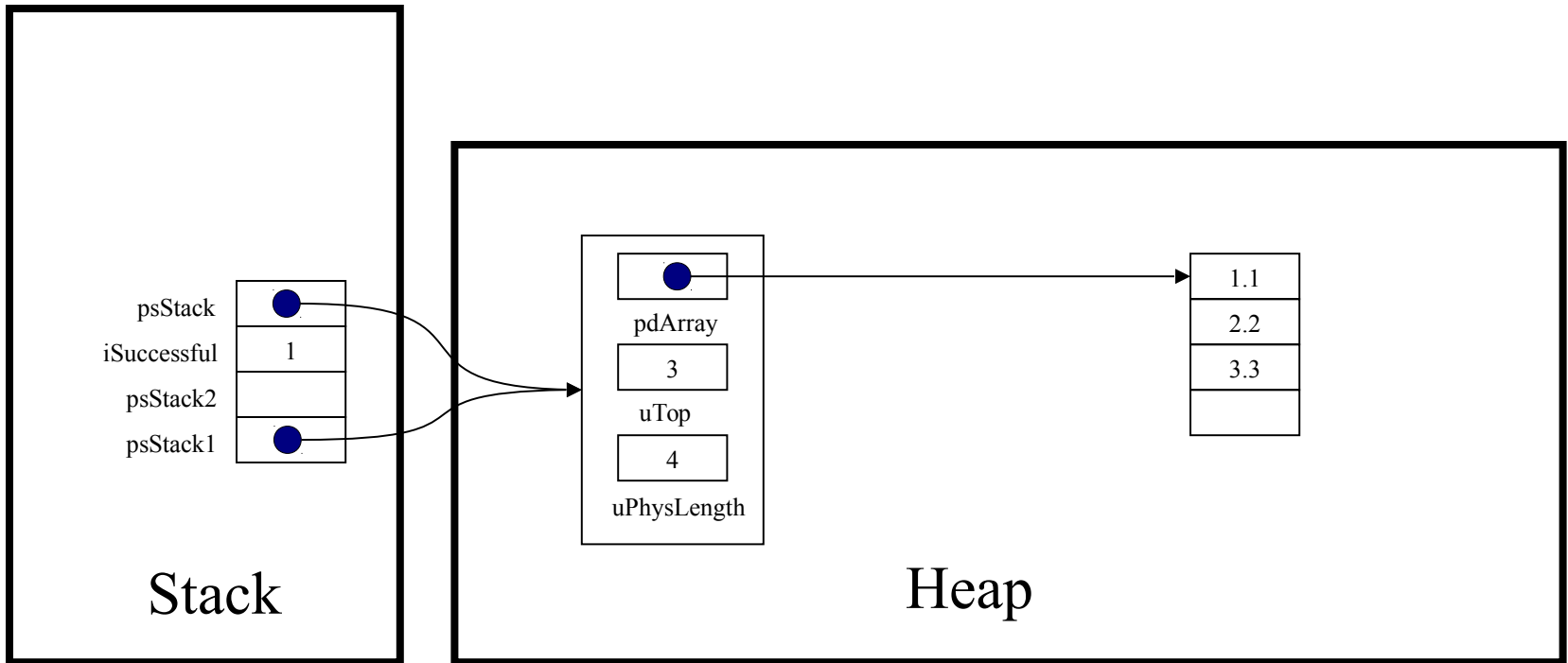

Princeton University
COS 217: Introduction to Programming Systems
Trace of teststack (Version 1)

```
assert (psStack != NULL);
```

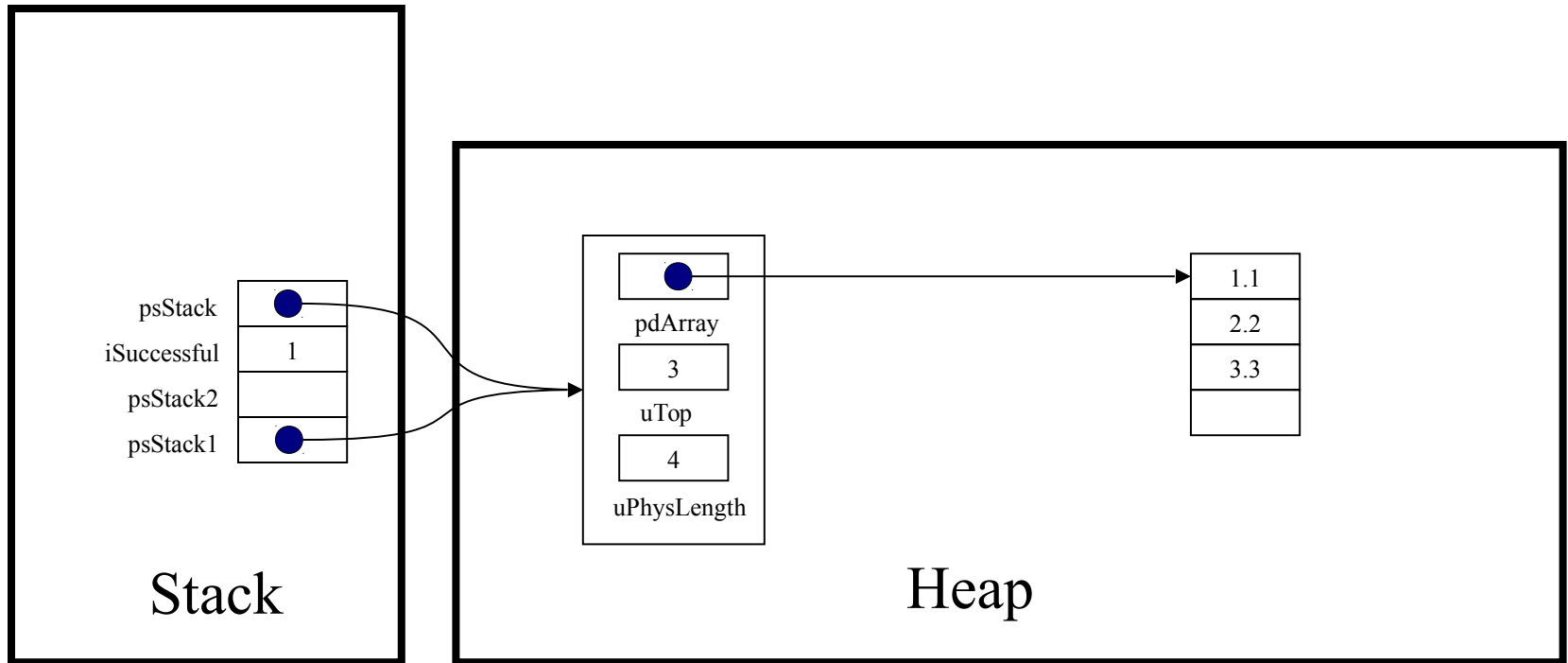

Princeton University
COS 217: Introduction to Programming Systems
Trace of teststack (Version 1)

```
assert (psStack->uTop > 0);
```

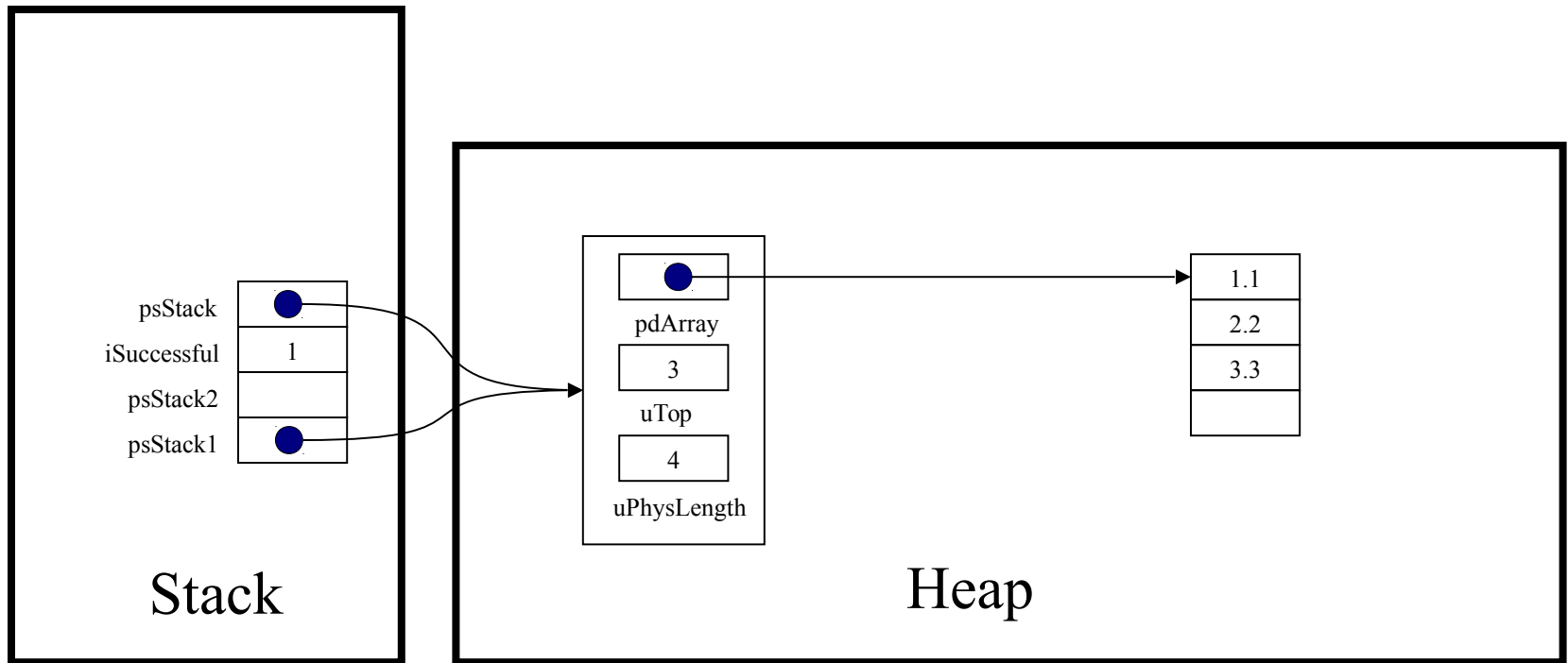

Princeton University
COS 217: Introduction to Programming Systems
Trace of teststack (Version 1)

```
(psStack->uTop) --;
```

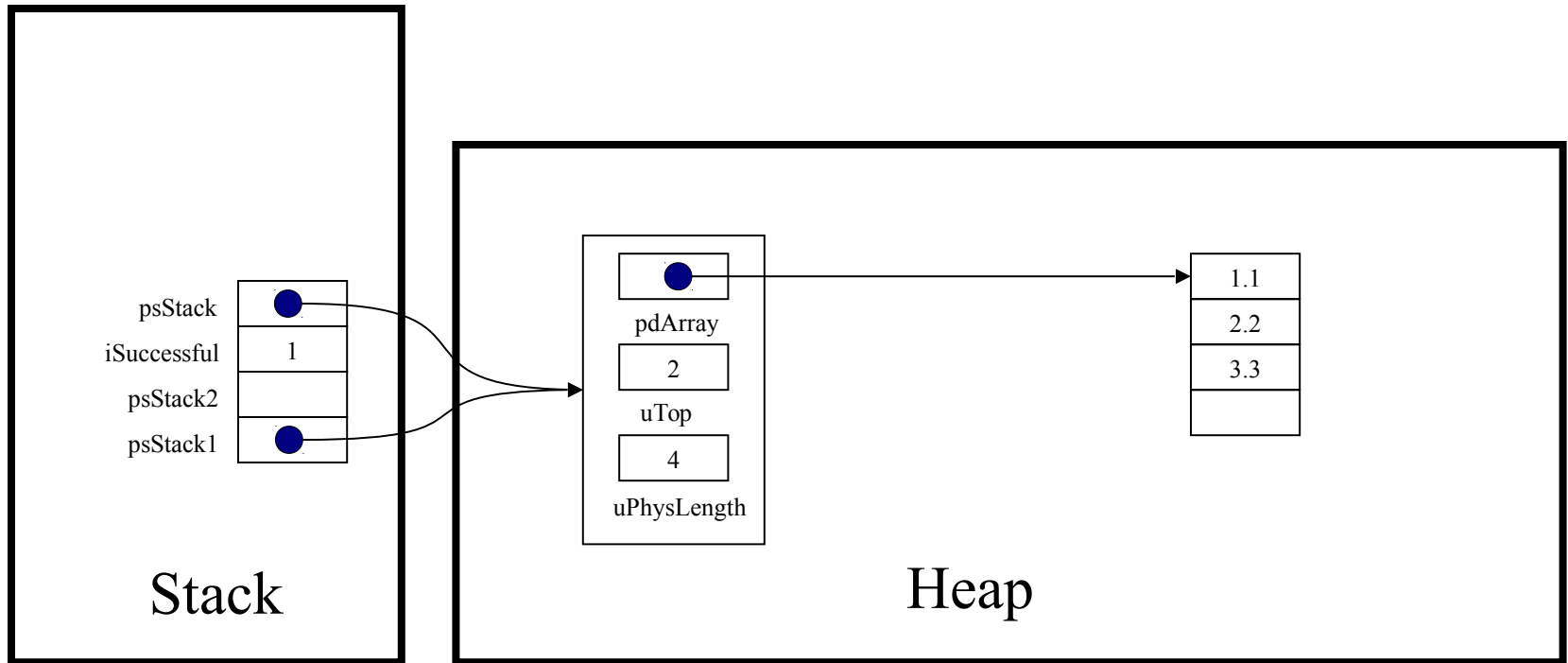

Princeton University
COS 217: Introduction to Programming Systems
Trace of teststack (Version 1)

```
return (psStack->pdArray)[psStack->uTop];
```

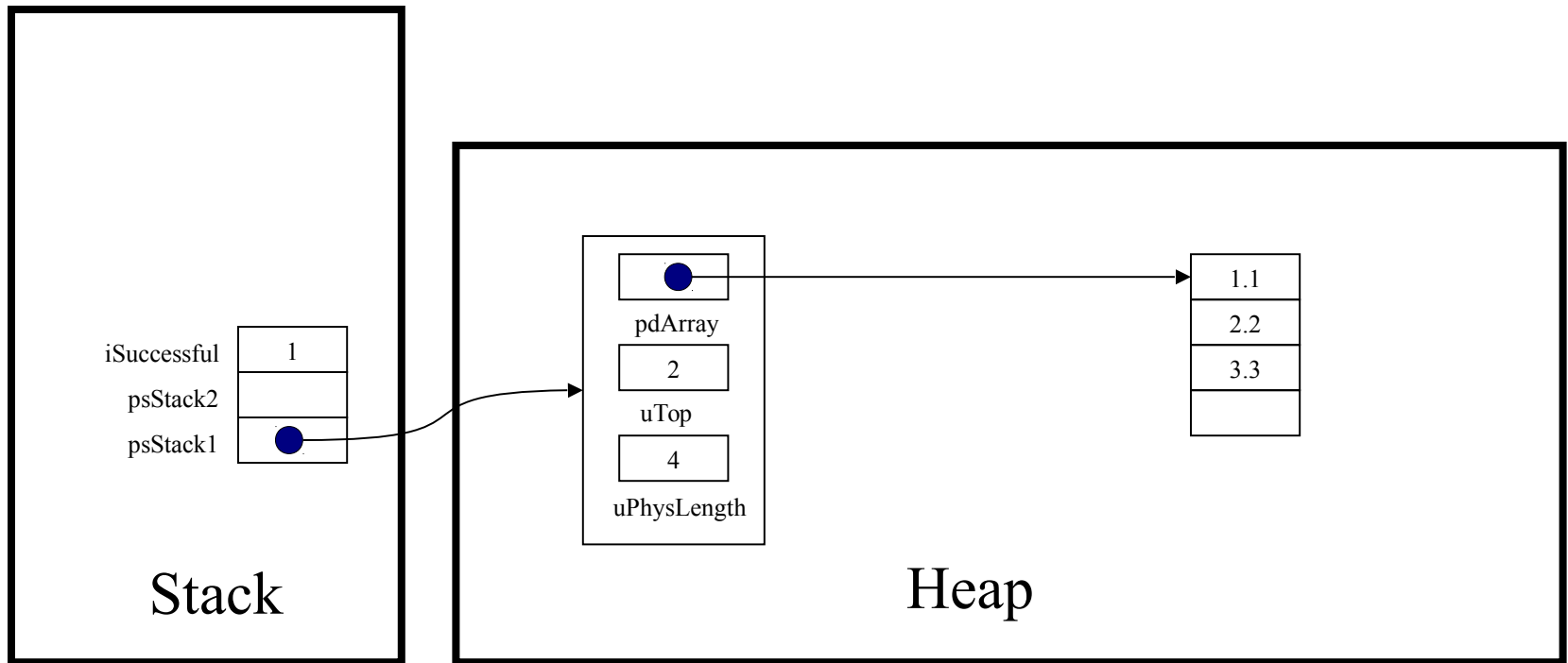

Princeton University
COS 217: Introduction to Programming Systems
Trace of teststack (Version 1)

```
printf("%g\n", Stack_pop(psStack1));
```

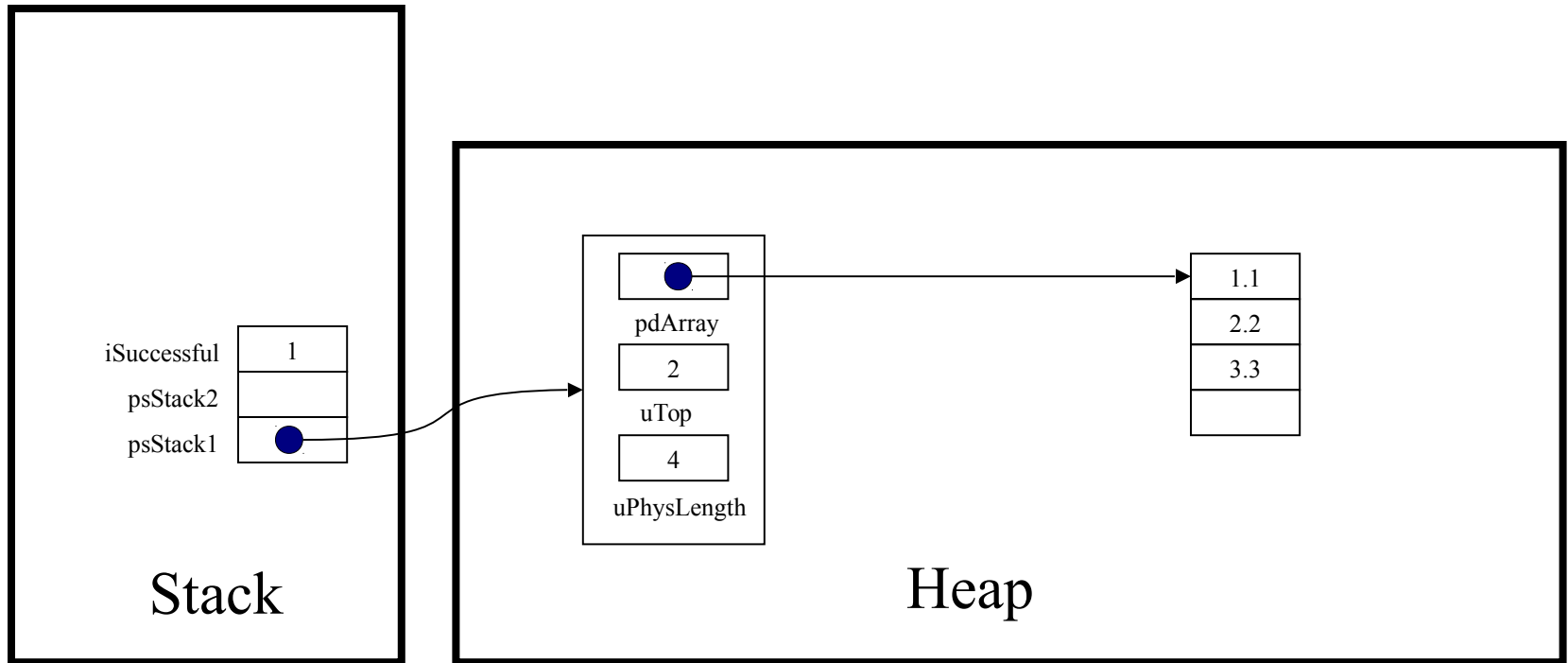

Princeton University
COS 217: Introduction to Programming Systems
Trace of teststack (Version 1)

```
while (! Stack_isEmpty(psStack1))  
    ...
```

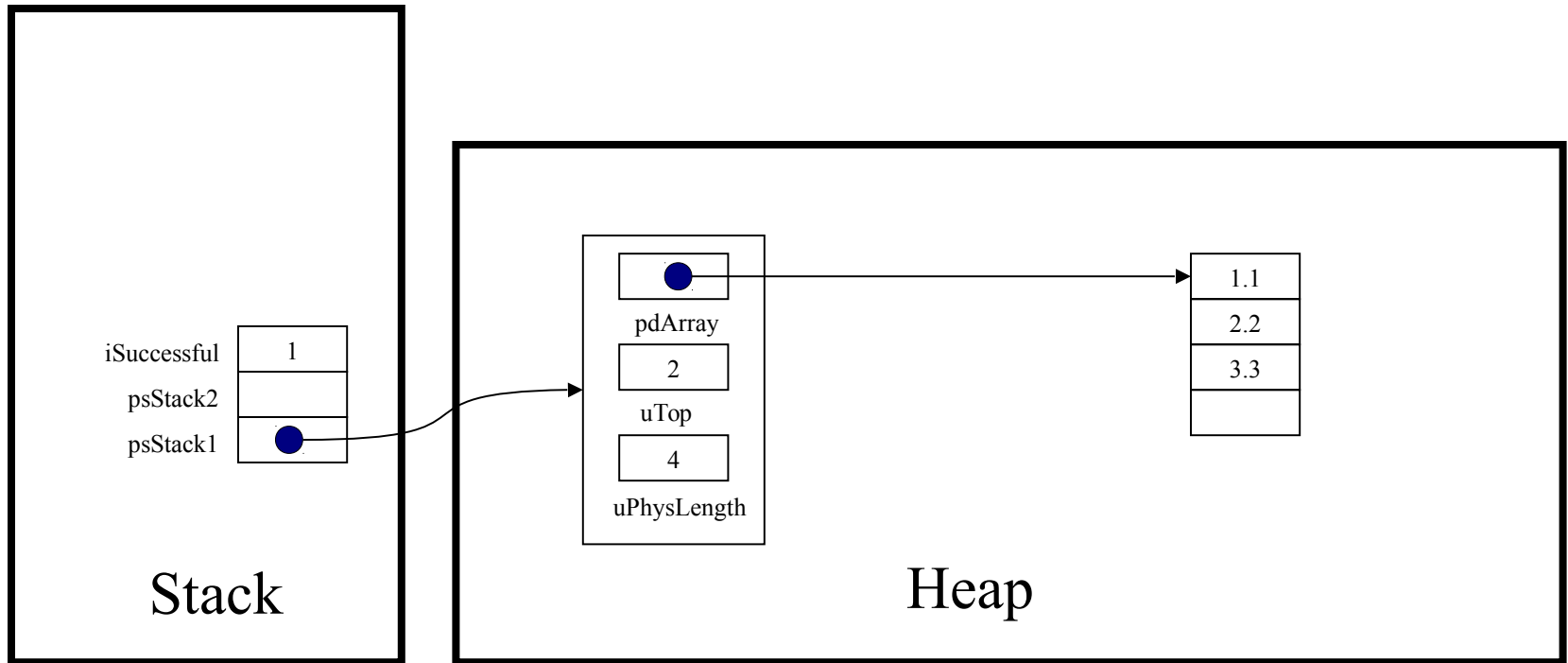

Princeton University
COS 217: Introduction to Programming Systems
Trace of teststack (Version 1)

```
int Stack_isEmpty(struct Stack *psStack)
```

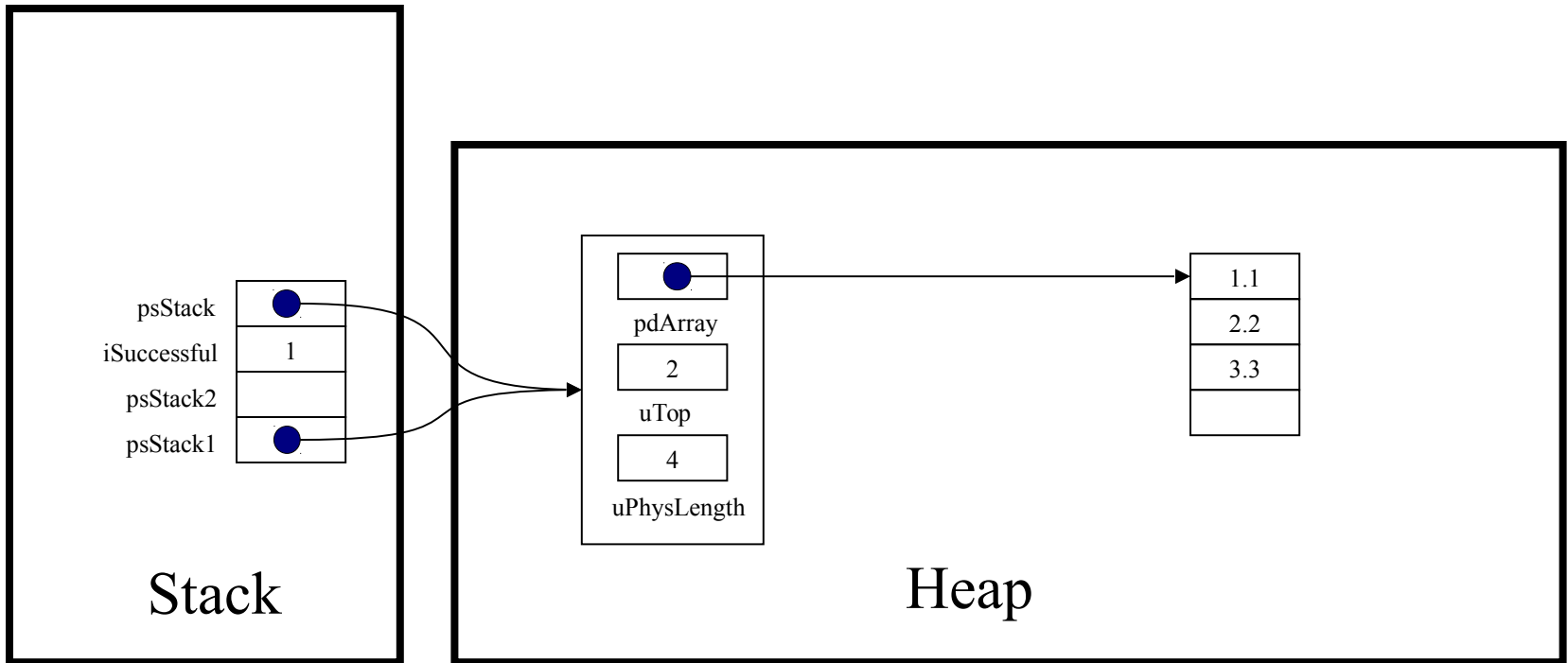

Princeton University
COS 217: Introduction to Programming Systems
Trace of teststack (Version 1)

```
assert (psStack != NULL);
```

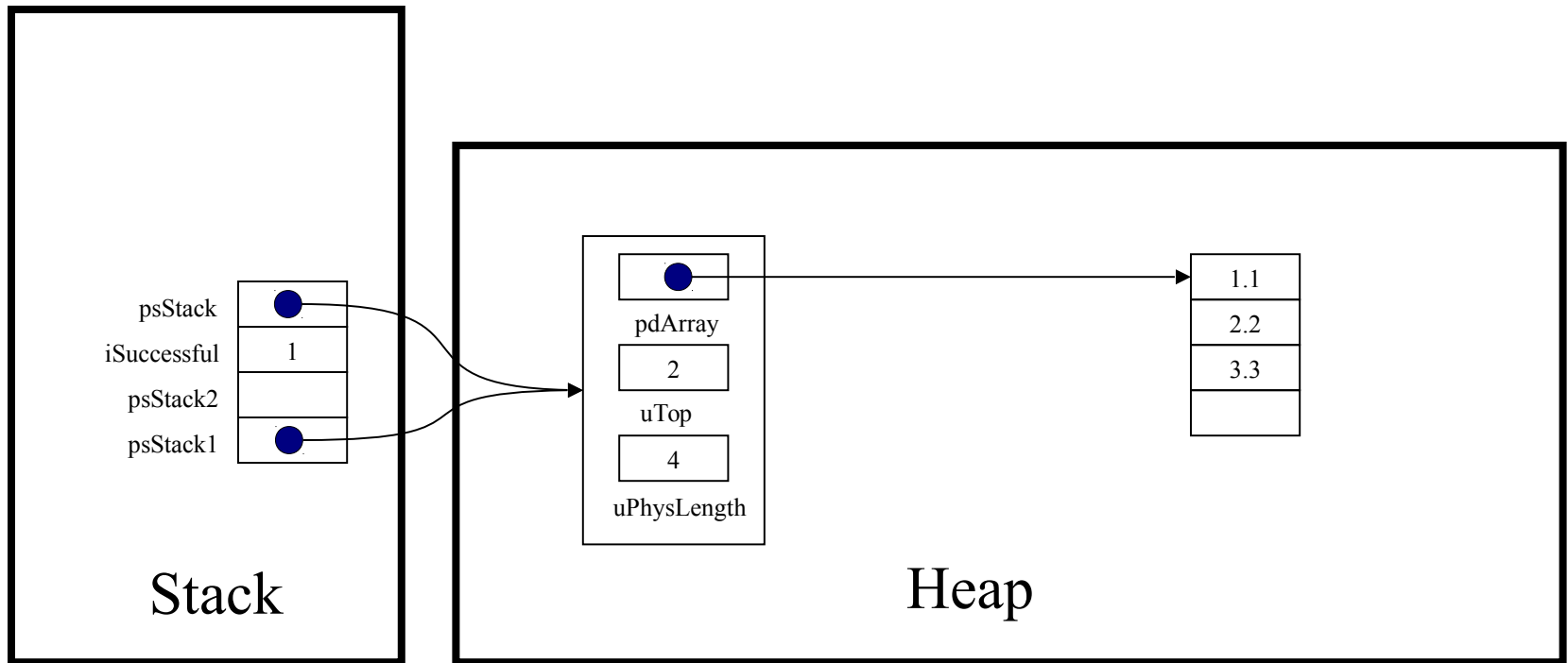

Princeton University
COS 217: Introduction to Programming Systems
Trace of teststack (Version 1)

```
return psStack->uTop == 0;
```

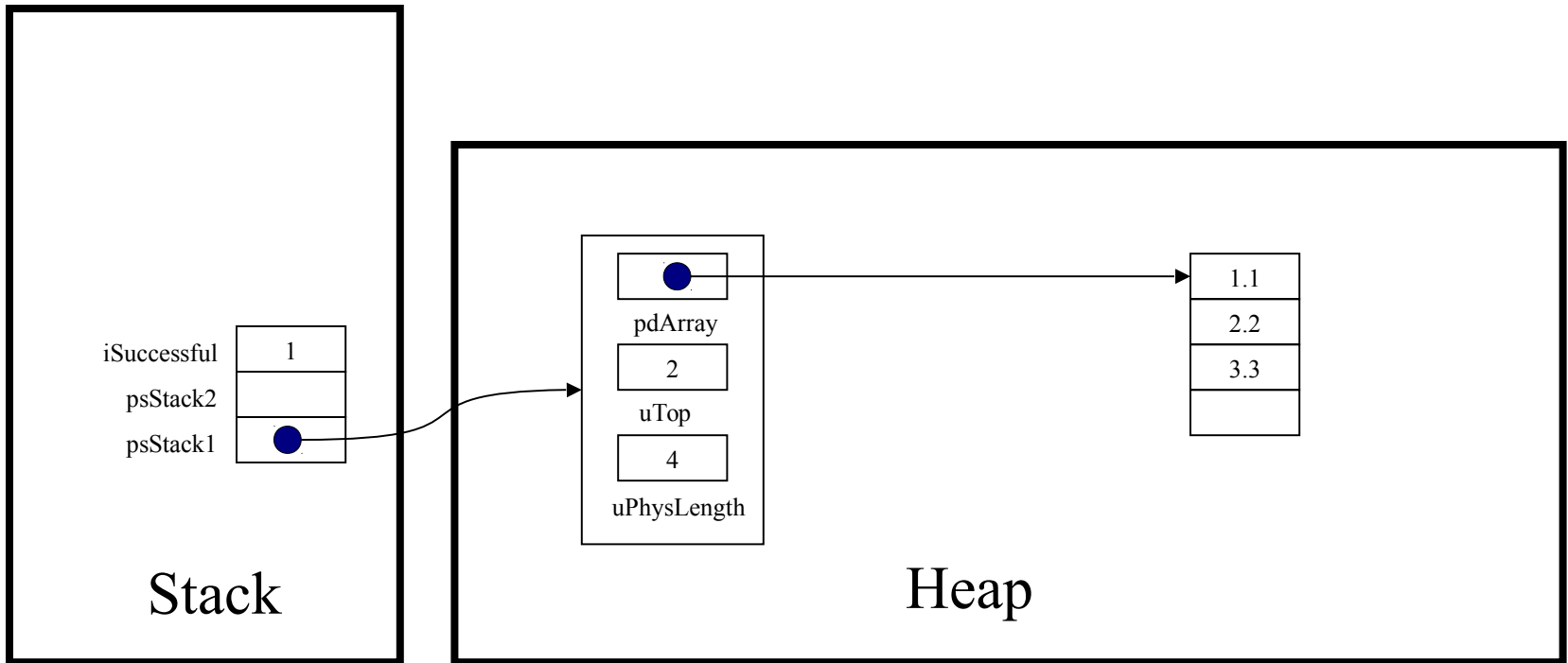

Princeton University
COS 217: Introduction to Programming Systems
Trace of teststack (Version 1)

```
while (! Stack_isEmpty(psStack1))
```

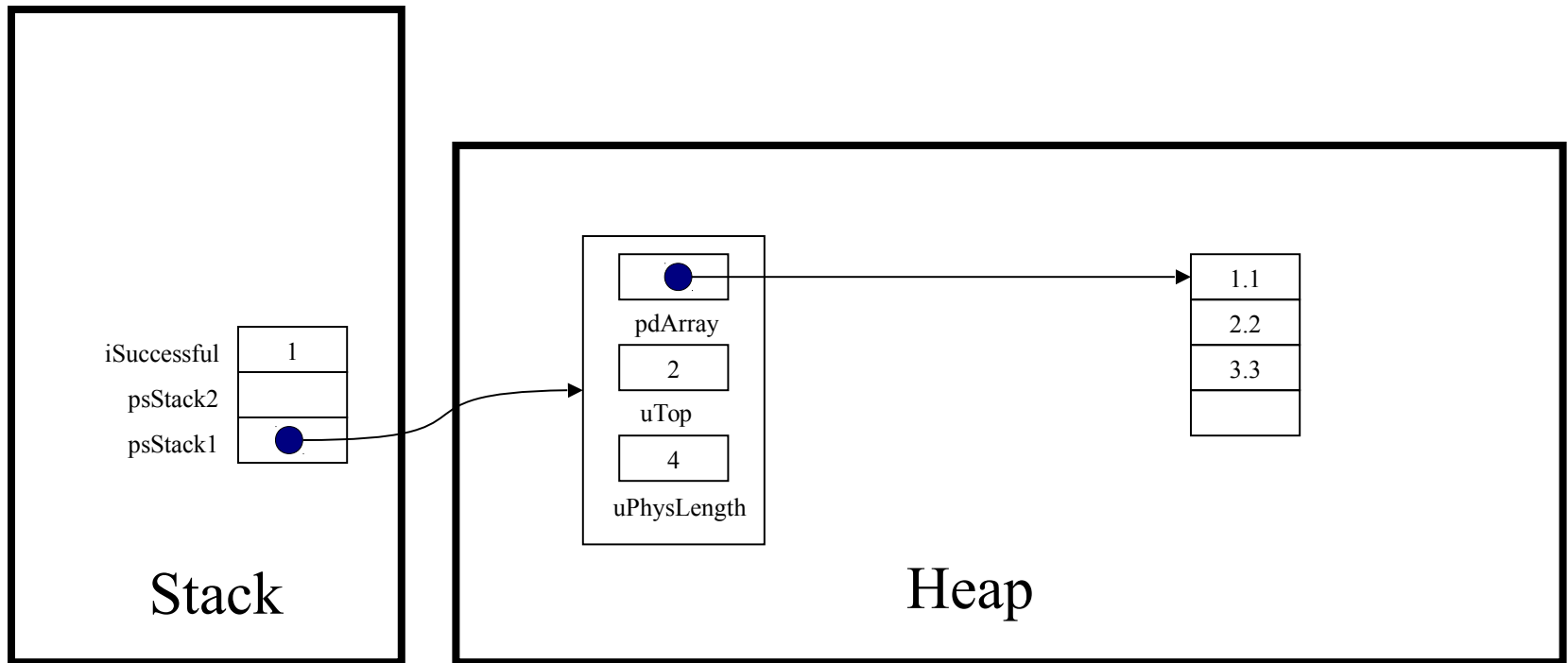

Princeton University
COS 217: Introduction to Programming Systems
Trace of teststack (Version 1)

```
printf("%g\n", Stack_pop(psStack1));
```

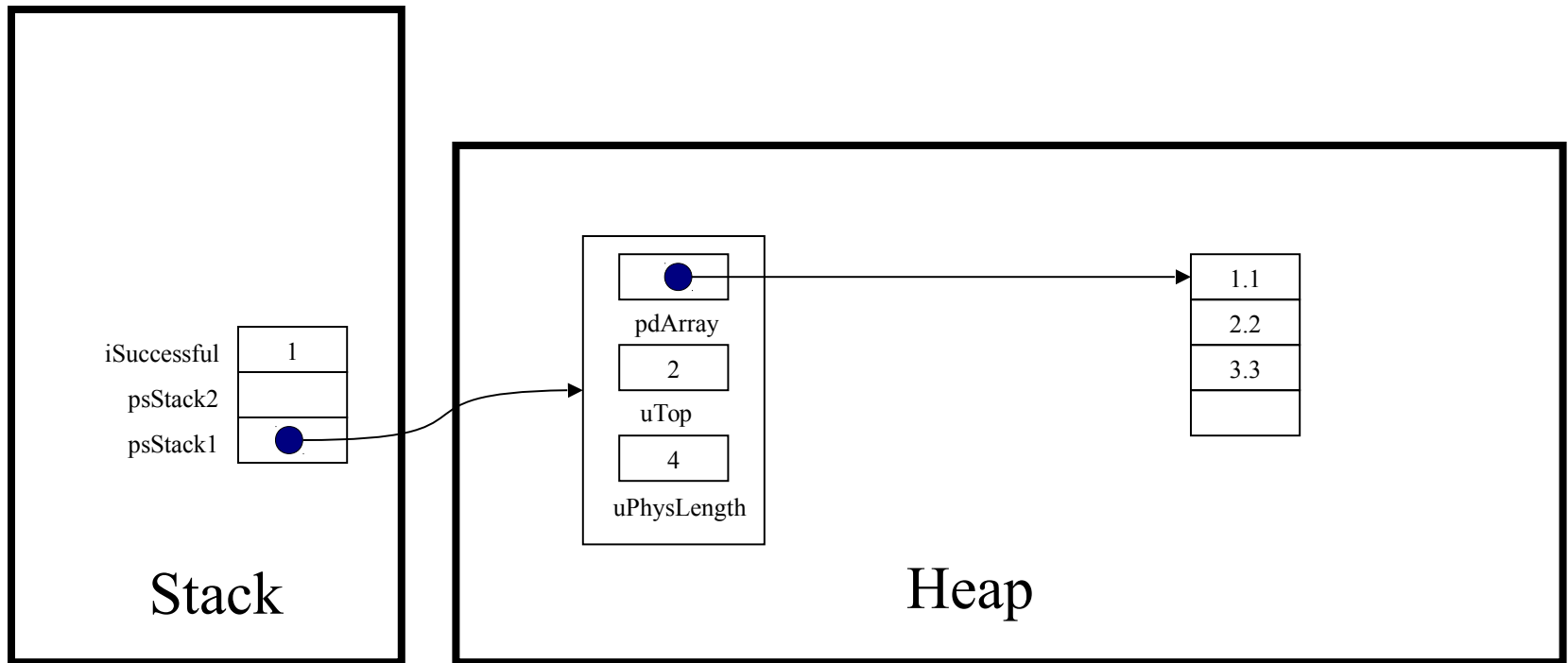

Princeton University
COS 217: Introduction to Programming Systems
Trace of teststack (Version 1)

```
double Stack_pop(struct Stack *psStack)
```

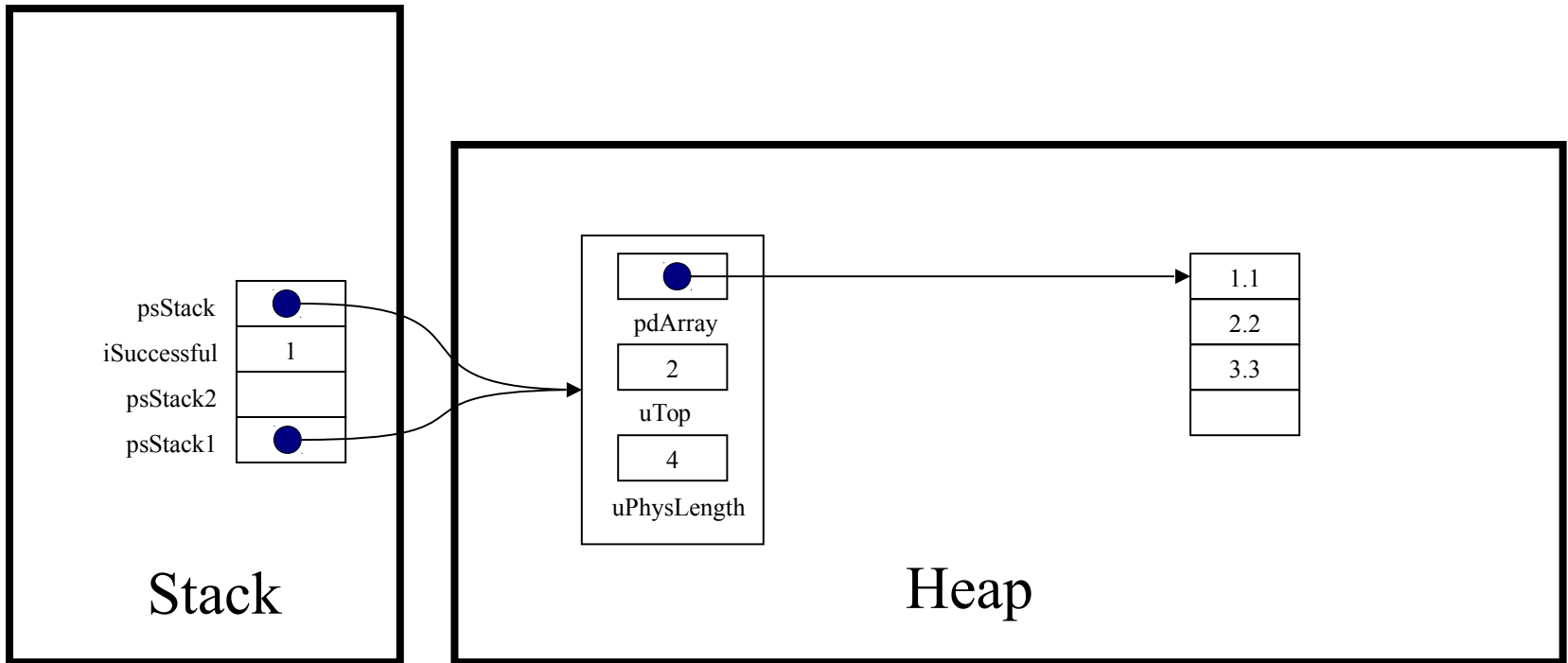

Princeton University
COS 217: Introduction to Programming Systems
Trace of teststack (Version 1)

```
assert (psStack != NULL);
```

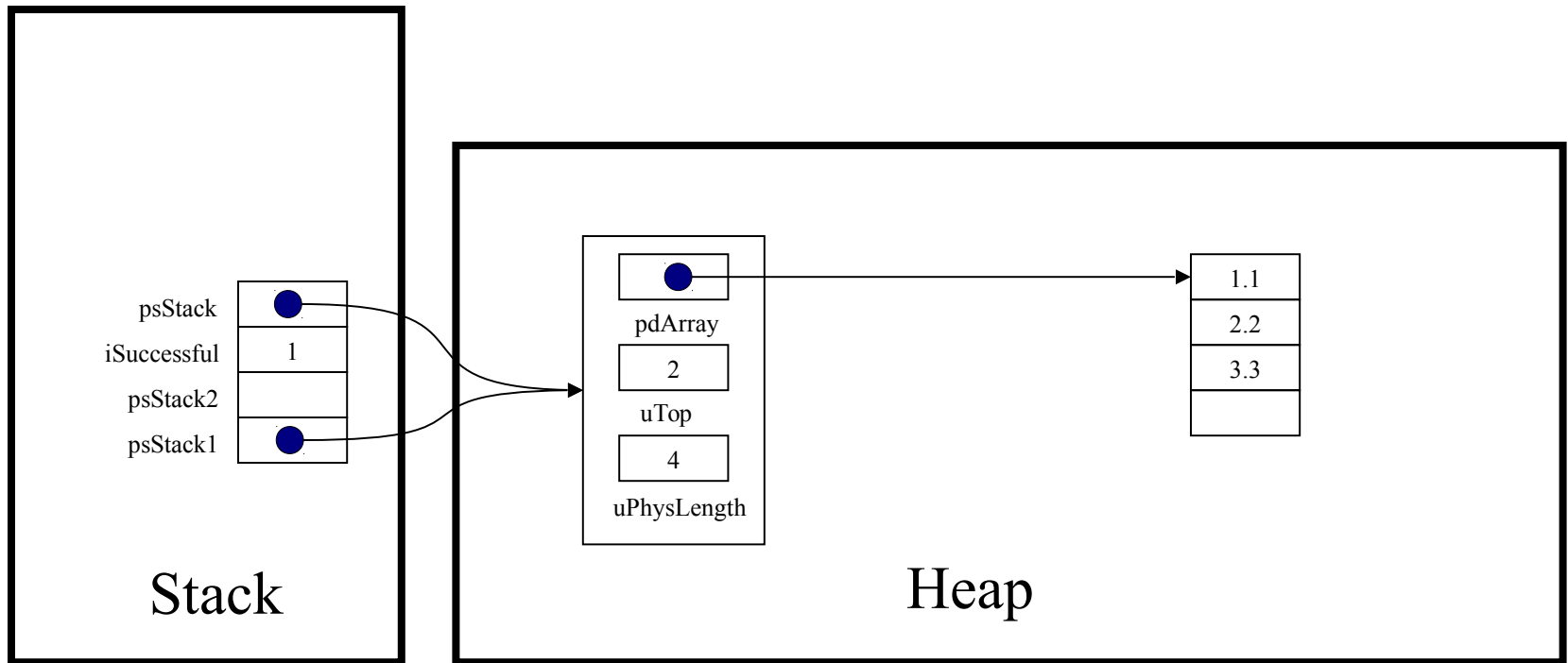

Princeton University
COS 217: Introduction to Programming Systems
Trace of teststack (Version 1)

```
assert (psStack->uTop > 0);
```

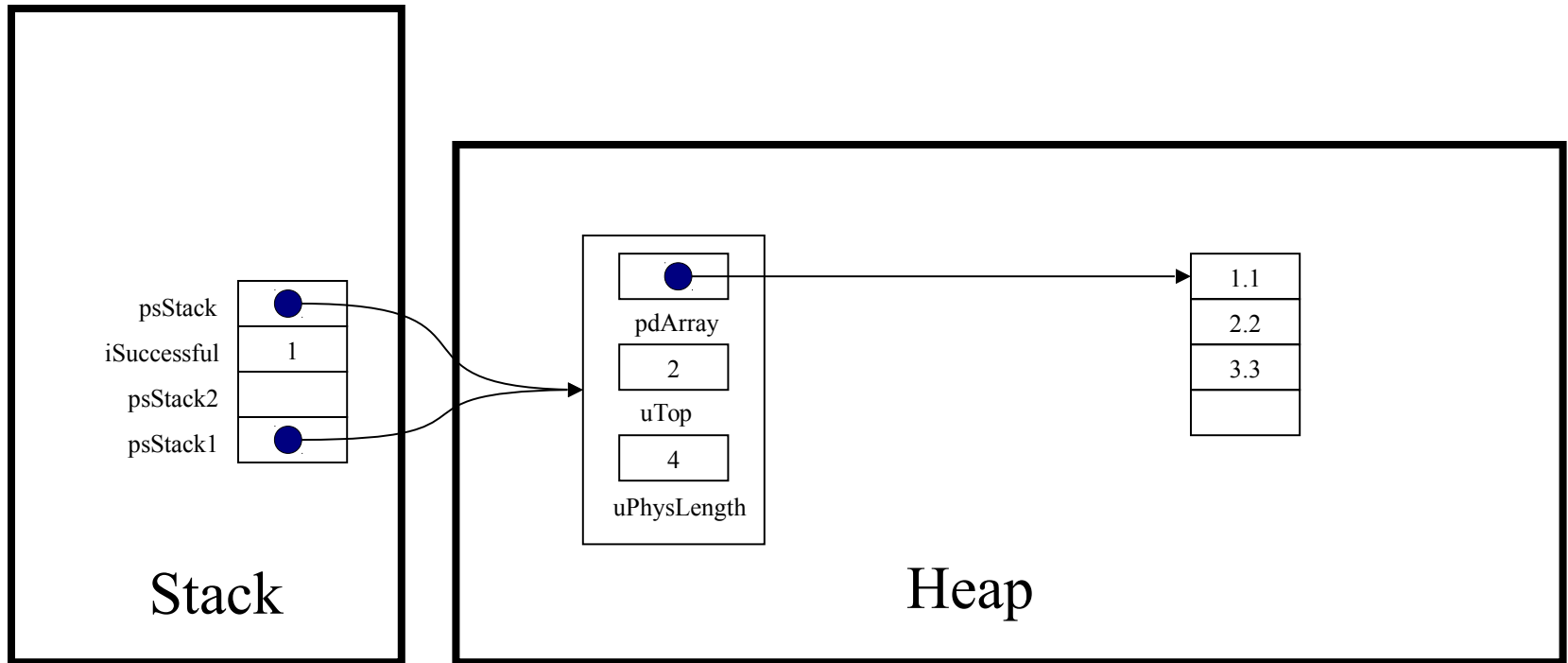

Princeton University
COS 217: Introduction to Programming Systems
Trace of teststack (Version 1)

```
(psStack->uTop) --;
```

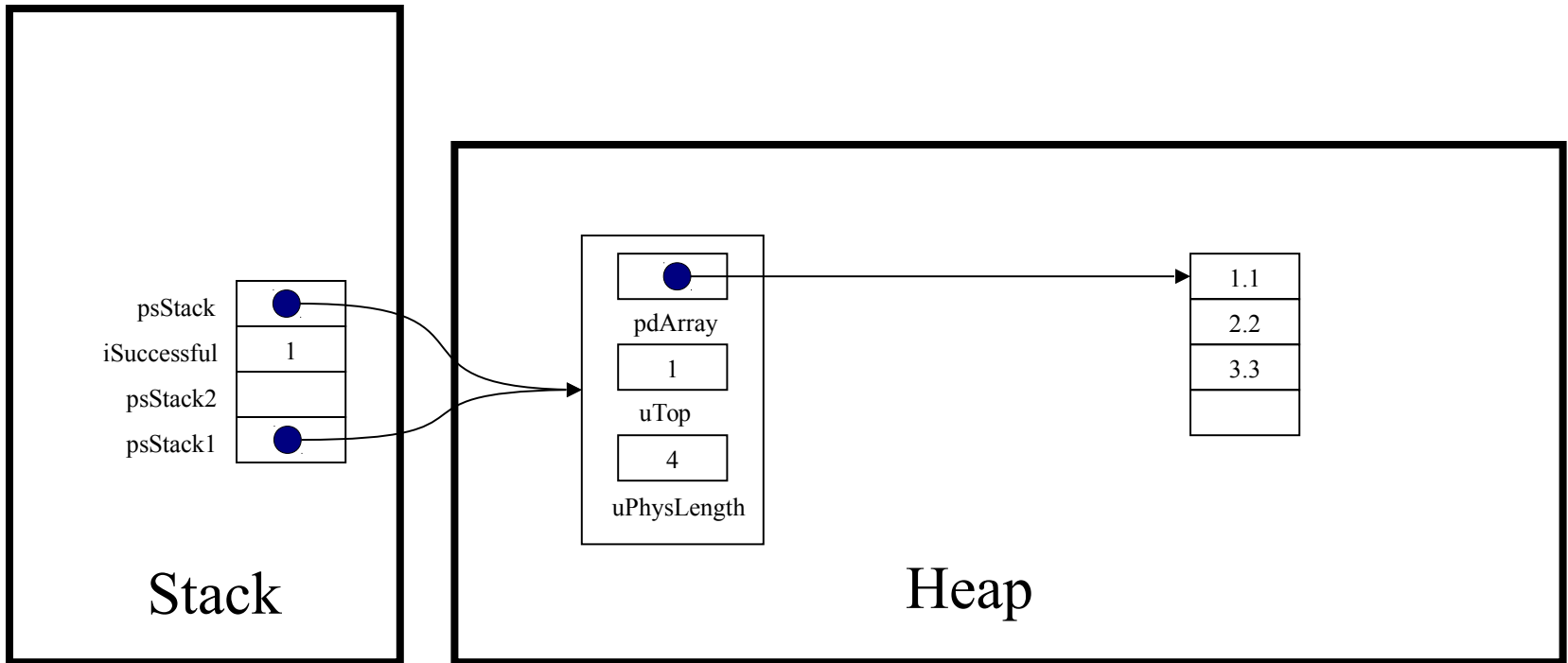

Princeton University
COS 217: Introduction to Programming Systems
Trace of teststack (Version 1)

```
return (psStack->pdArray)[psStack->uTop];
```

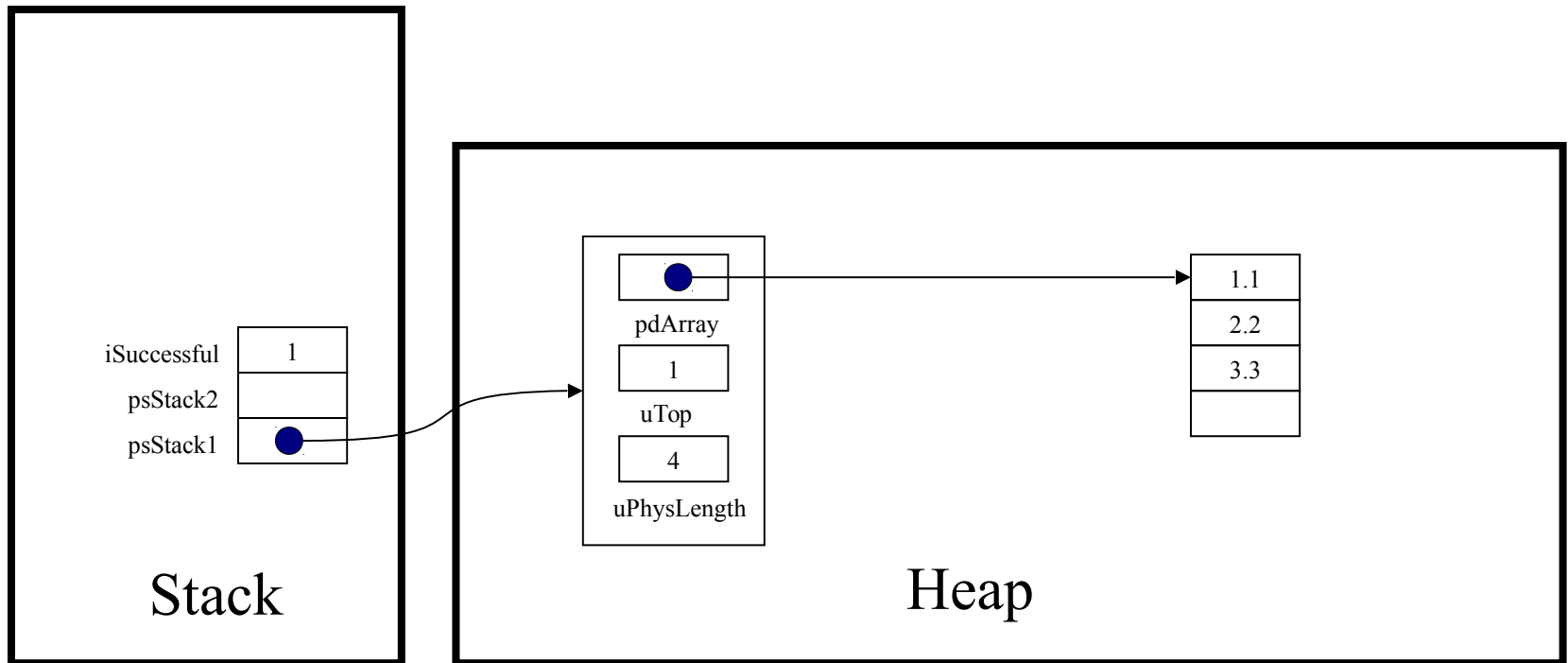

Princeton University
COS 217: Introduction to Programming Systems
Trace of teststack (Version 1)

```
printf("%g\n", Stack_pop(psStack1));
```

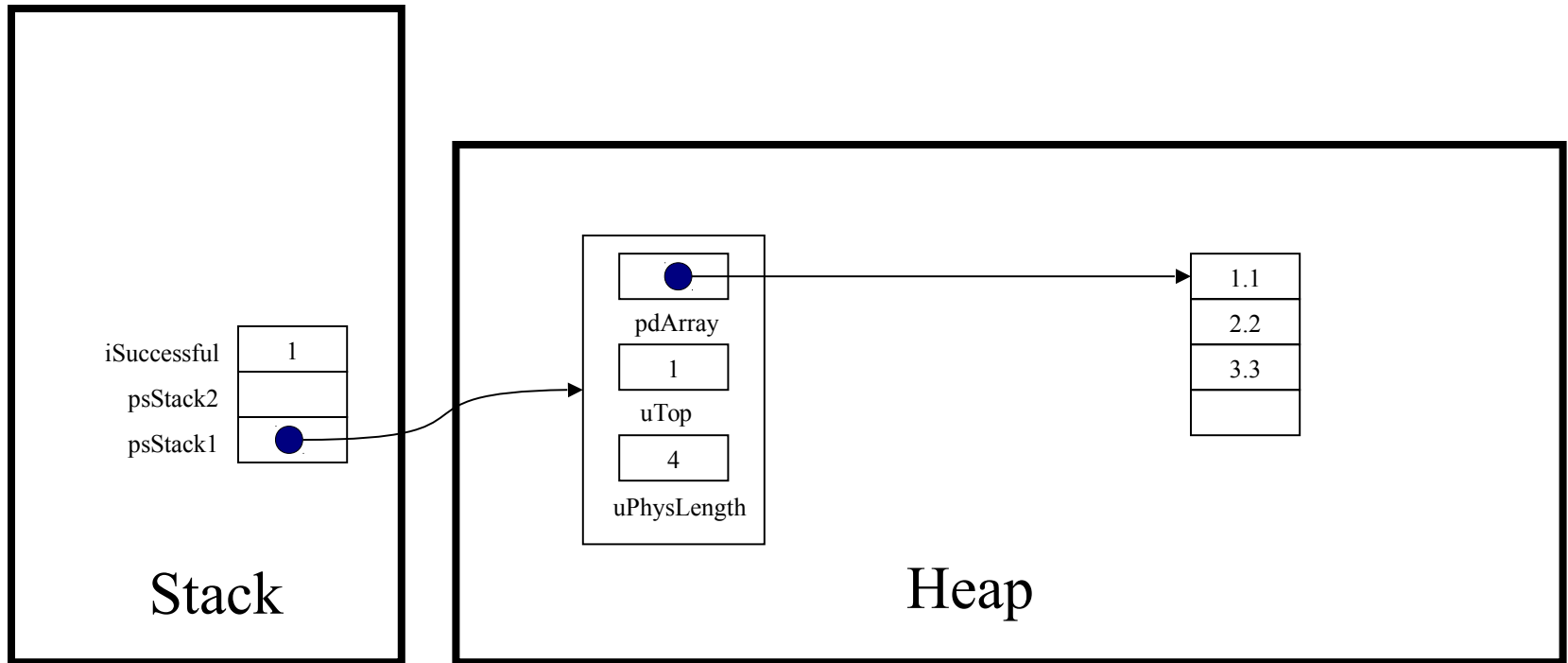

Princeton University
COS 217: Introduction to Programming Systems
Trace of teststack (Version 1)

```
while (! Stack_isEmpty(psStack1))  
    ...
```

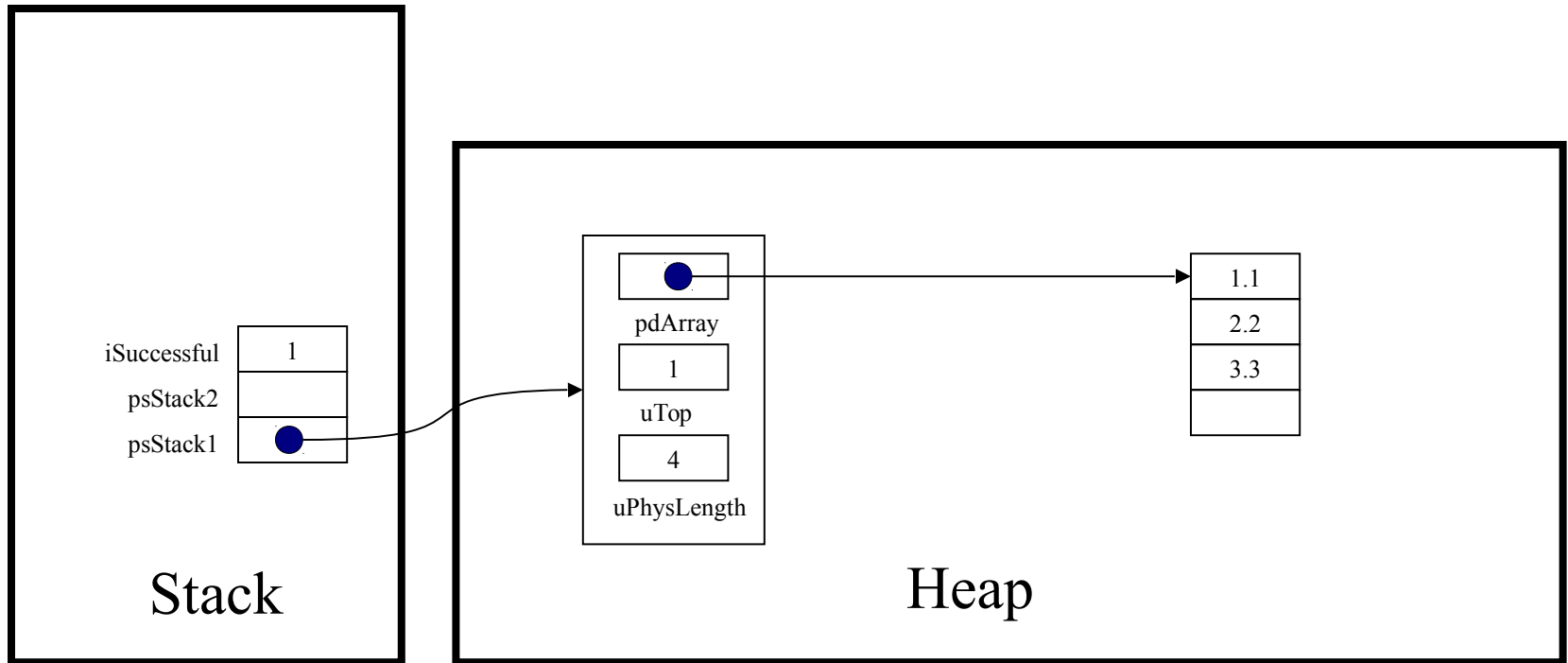

Princeton University
COS 217: Introduction to Programming Systems
Trace of teststack (Version 1)

```
int Stack_isEmpty(struct Stack *psStack)
```

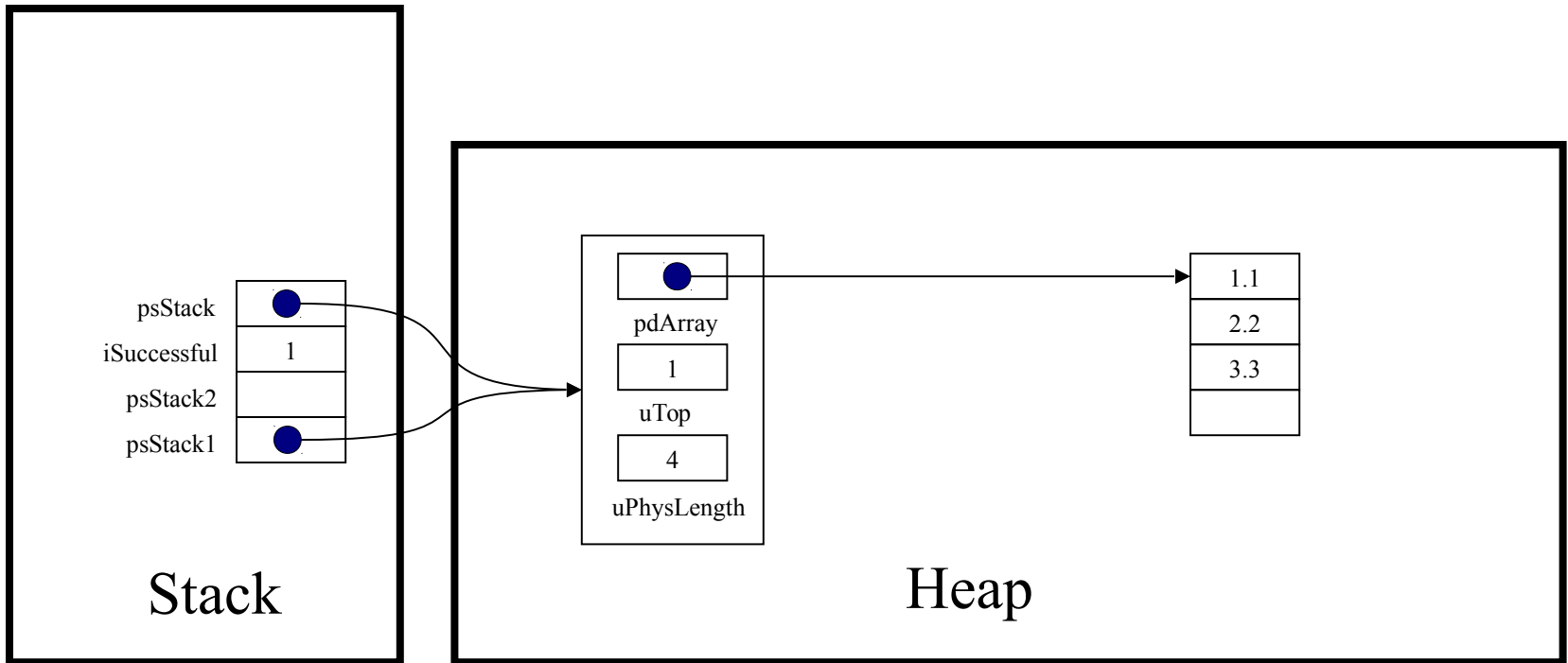

Princeton University
COS 217: Introduction to Programming Systems
Trace of teststack (Version 1)

```
assert (psStack != NULL);
```

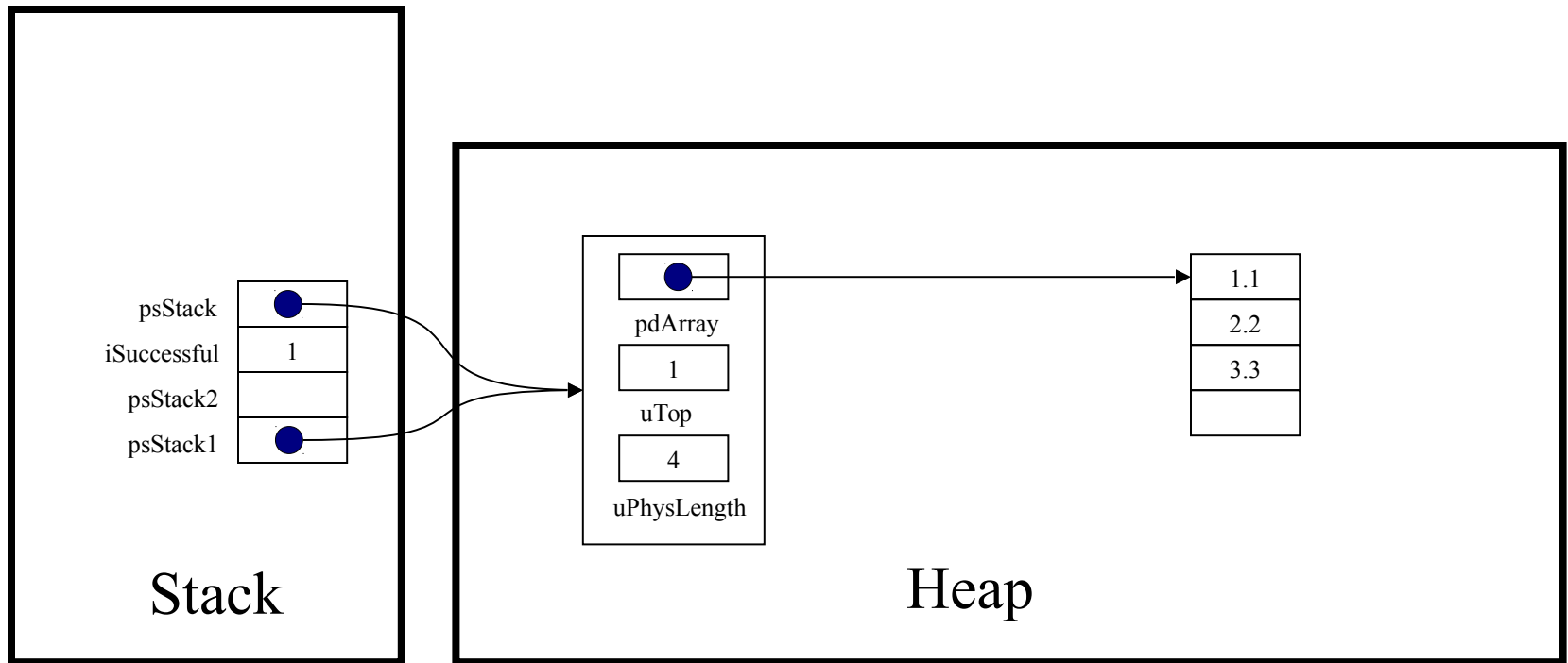

Princeton University
COS 217: Introduction to Programming Systems
Trace of teststack (Version 1)

```
return psStack->uTop == 0;
```

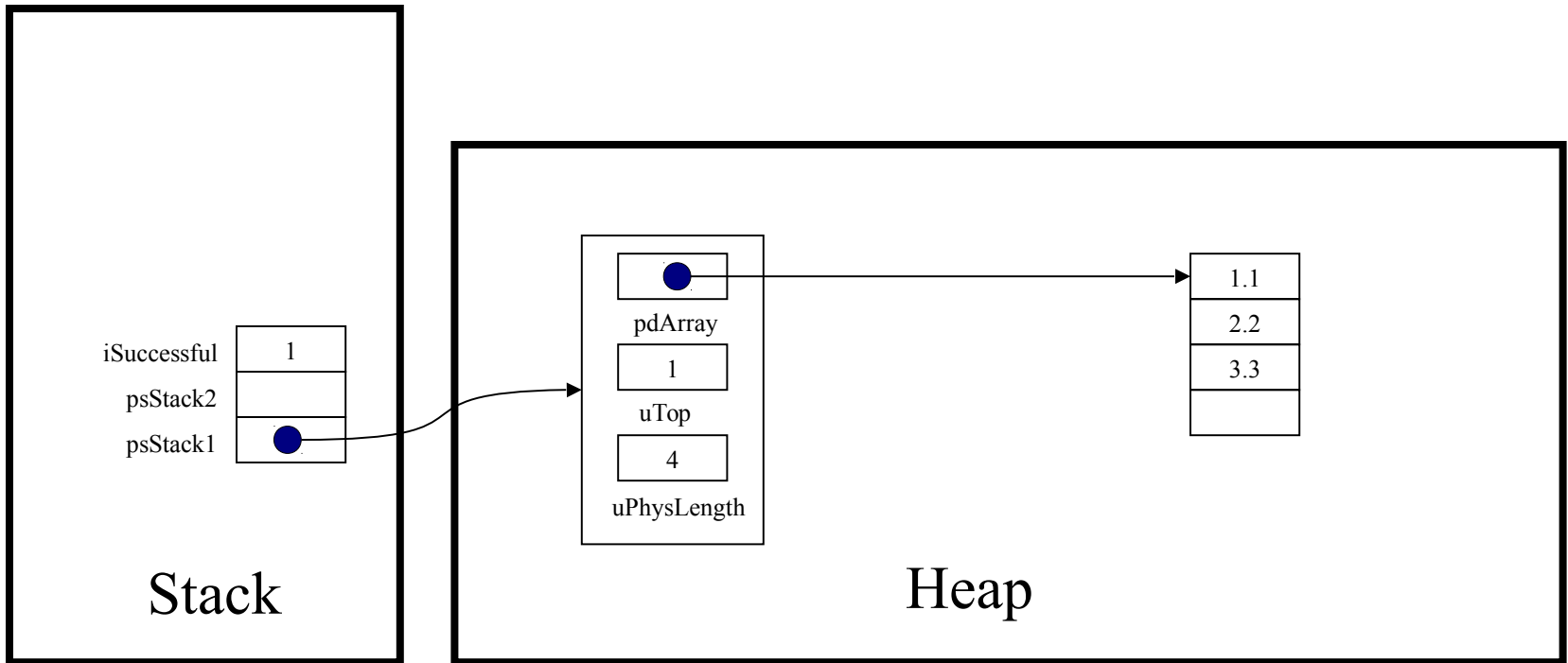

Princeton University
COS 217: Introduction to Programming Systems
Trace of teststack (Version 1)

```
while (! Stack_isEmpty(psStack1))
```

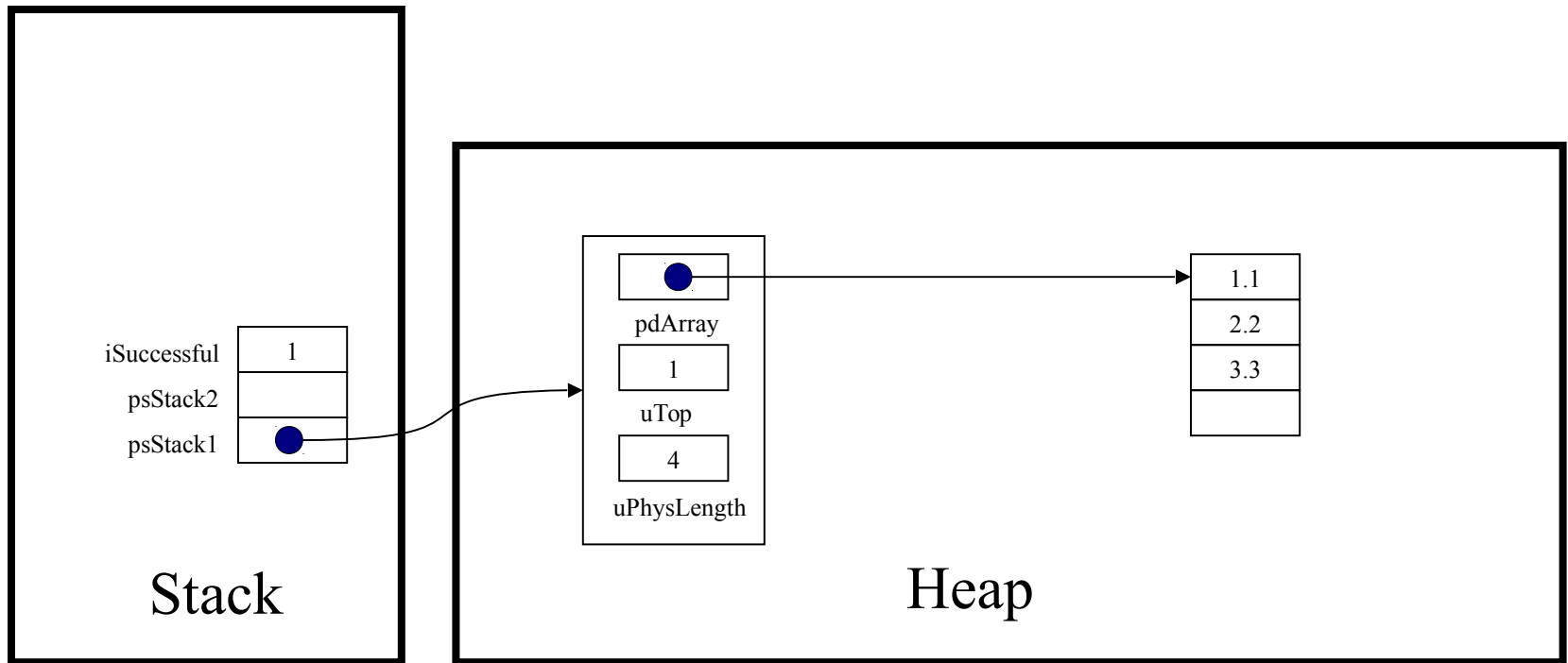

Princeton University
COS 217: Introduction to Programming Systems
Trace of teststack (Version 1)

```
printf("%g\n", Stack_pop(psStack1));
```

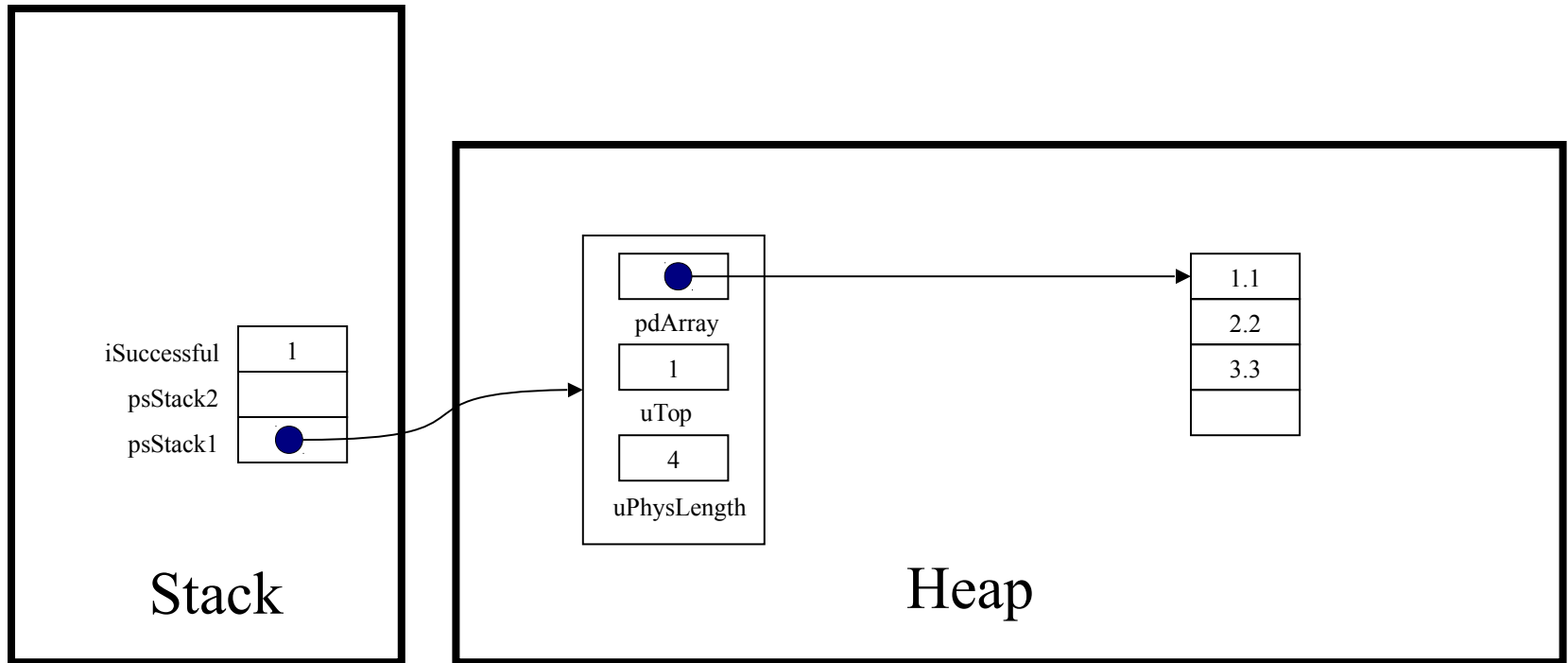

Princeton University
COS 217: Introduction to Programming Systems
Trace of teststack (Version 1)

```
double Stack_pop(struct Stack *psStack)
```

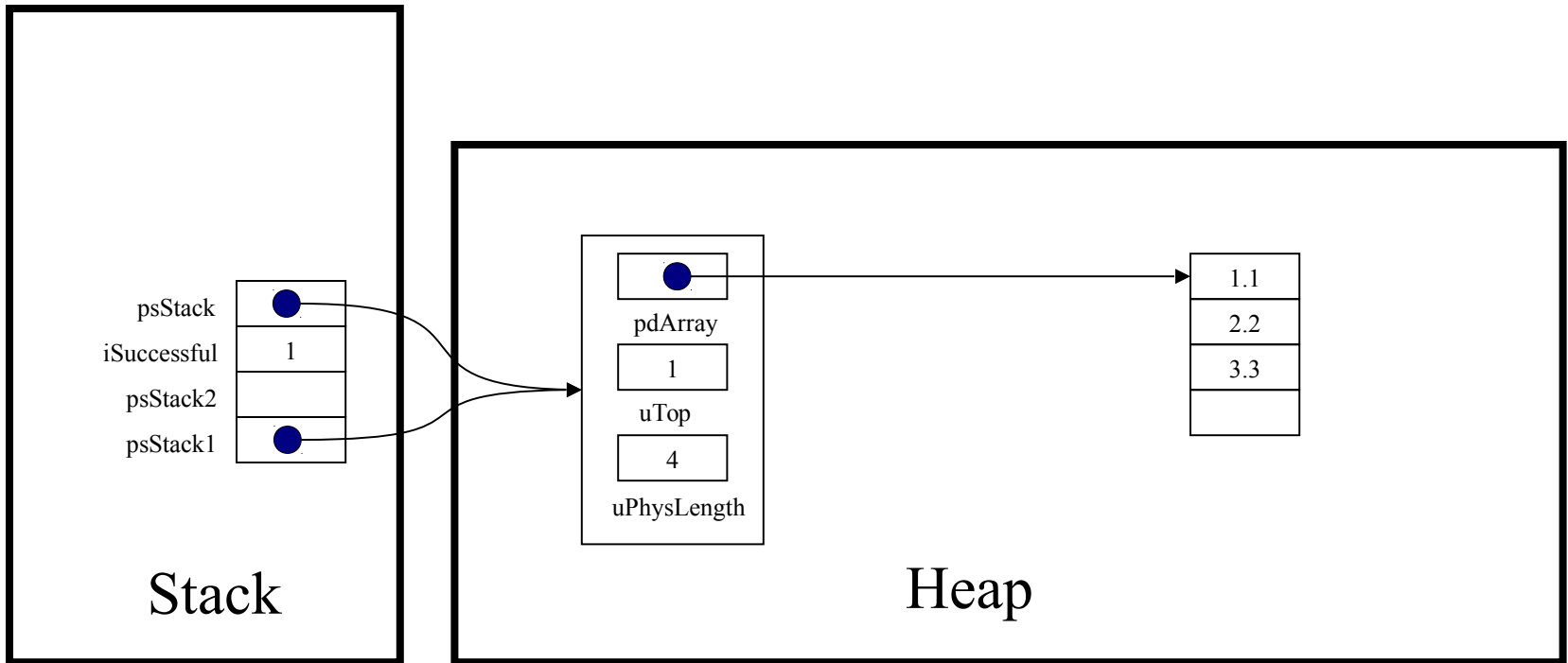

Princeton University
COS 217: Introduction to Programming Systems
Trace of teststack (Version 1)

```
assert (psStack != NULL);
```

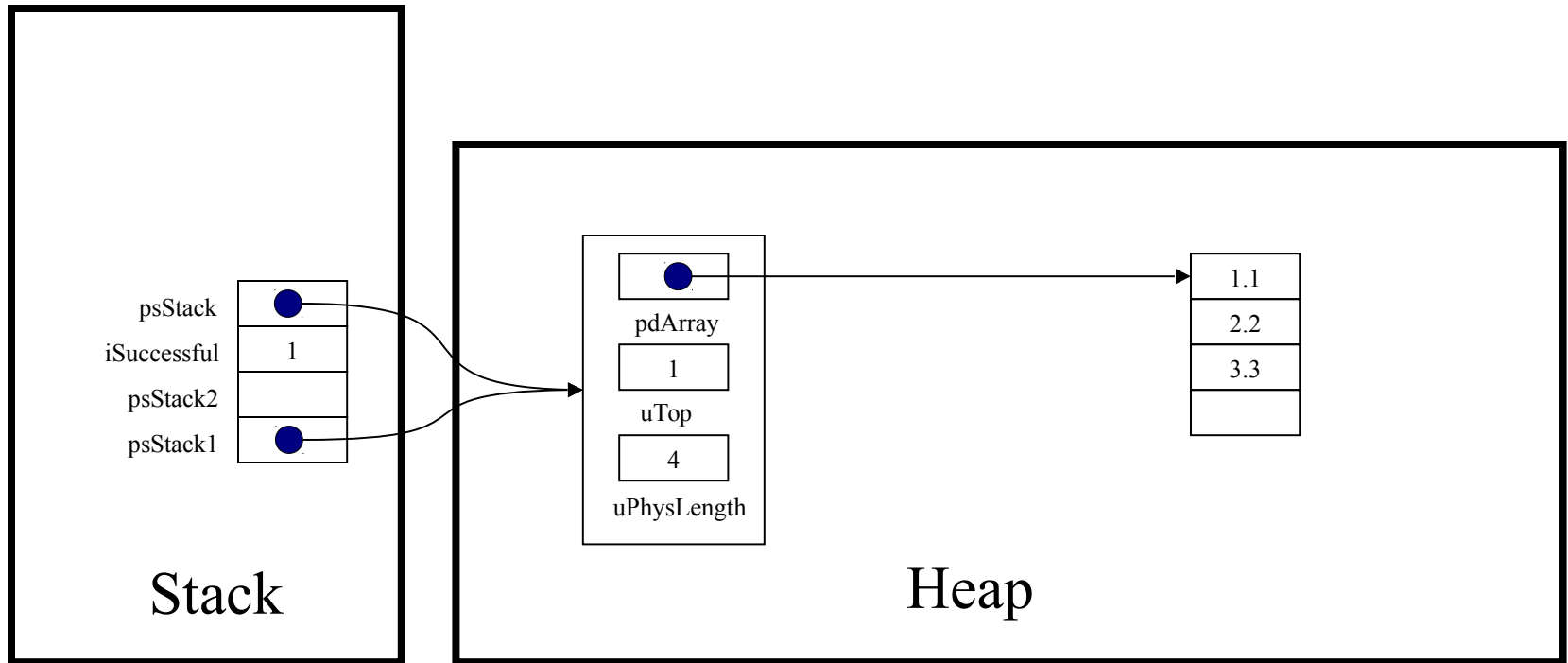

Princeton University
COS 217: Introduction to Programming Systems
Trace of teststack (Version 1)

```
assert (psStack->uTop > 0);
```

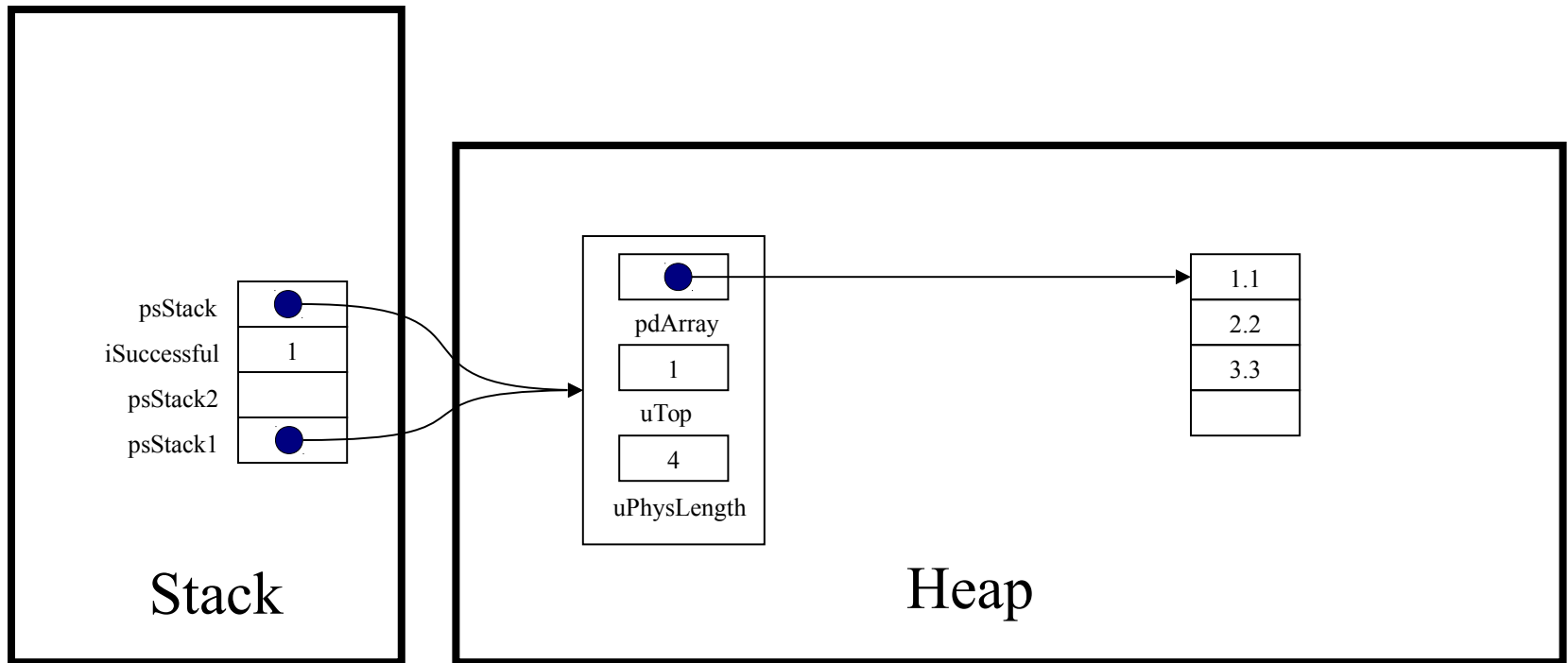

Princeton University
COS 217: Introduction to Programming Systems
Trace of teststack (Version 1)

```
(psStack->uTop) --;
```

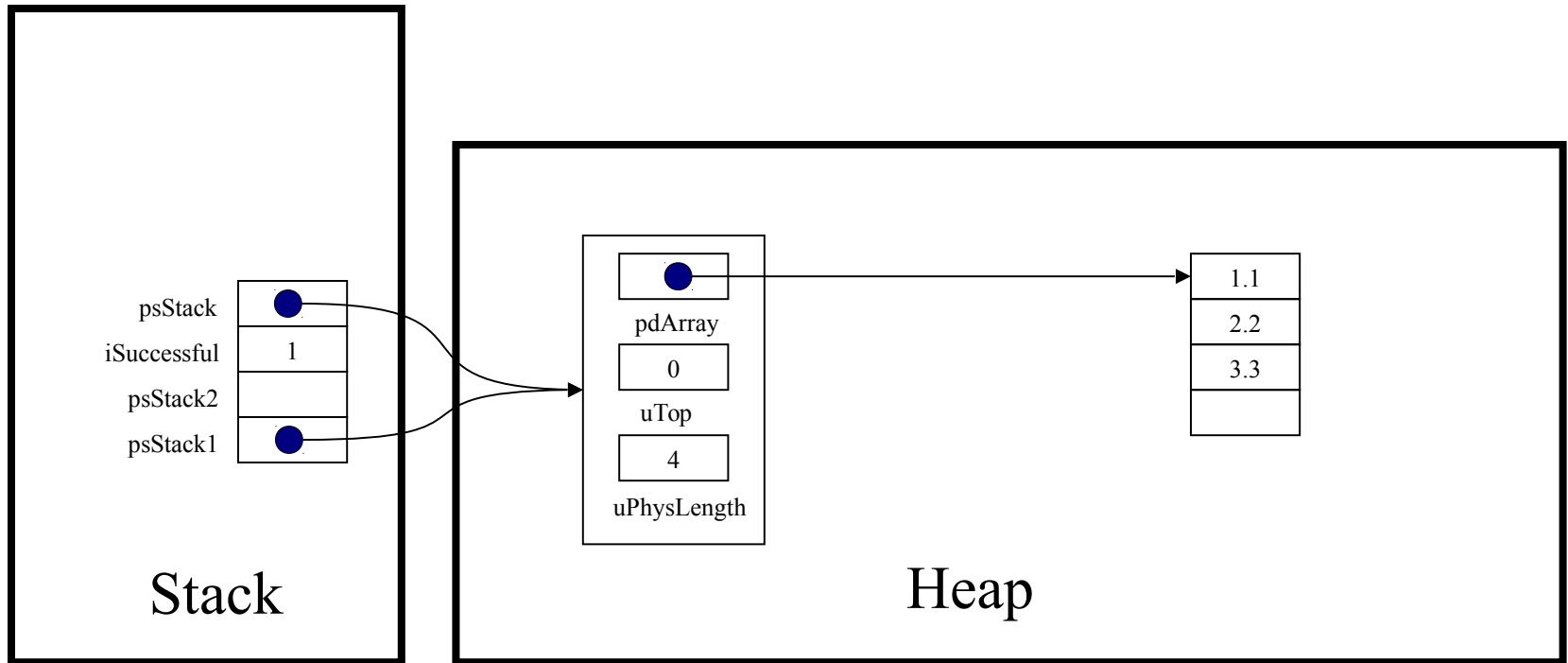

Princeton University
COS 217: Introduction to Programming Systems
Trace of teststack (Version 1)

```
return (psStack->pdArray) [psStack->uTop];
```

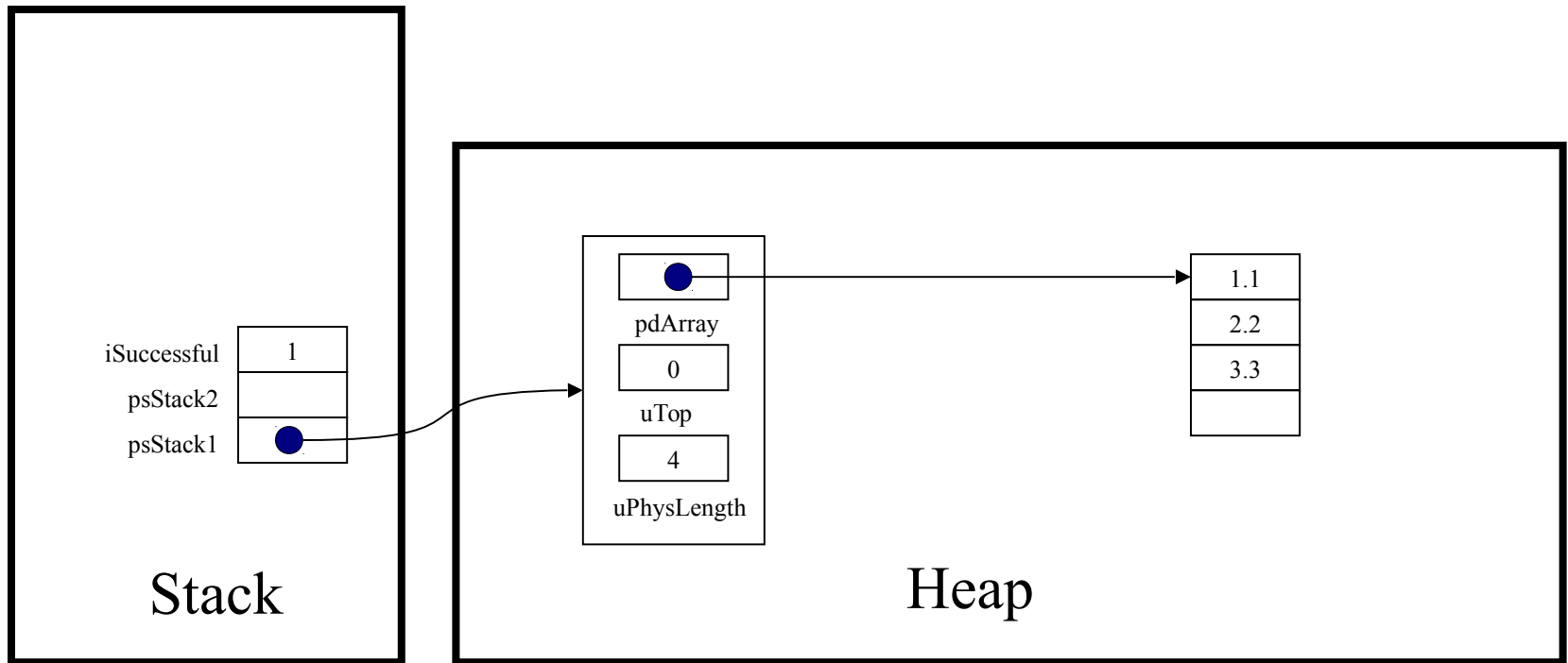

Princeton University
COS 217: Introduction to Programming Systems
Trace of teststack (Version 1)

```
printf("%g\n", Stack_pop(psStack1));
```

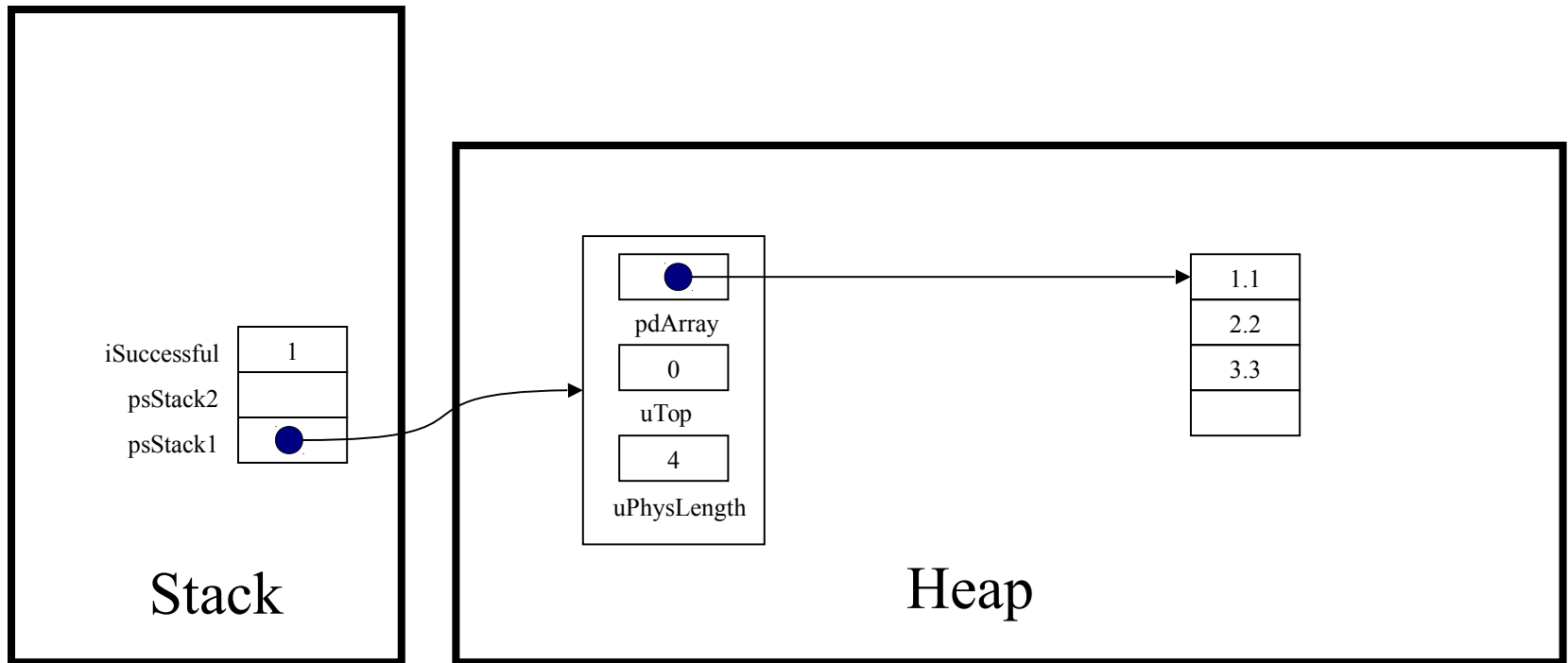

Princeton University
COS 217: Introduction to Programming Systems
Trace of teststack (Version 1)

```
while (! Stack_isEmpty(psStack1))  
    ...
```

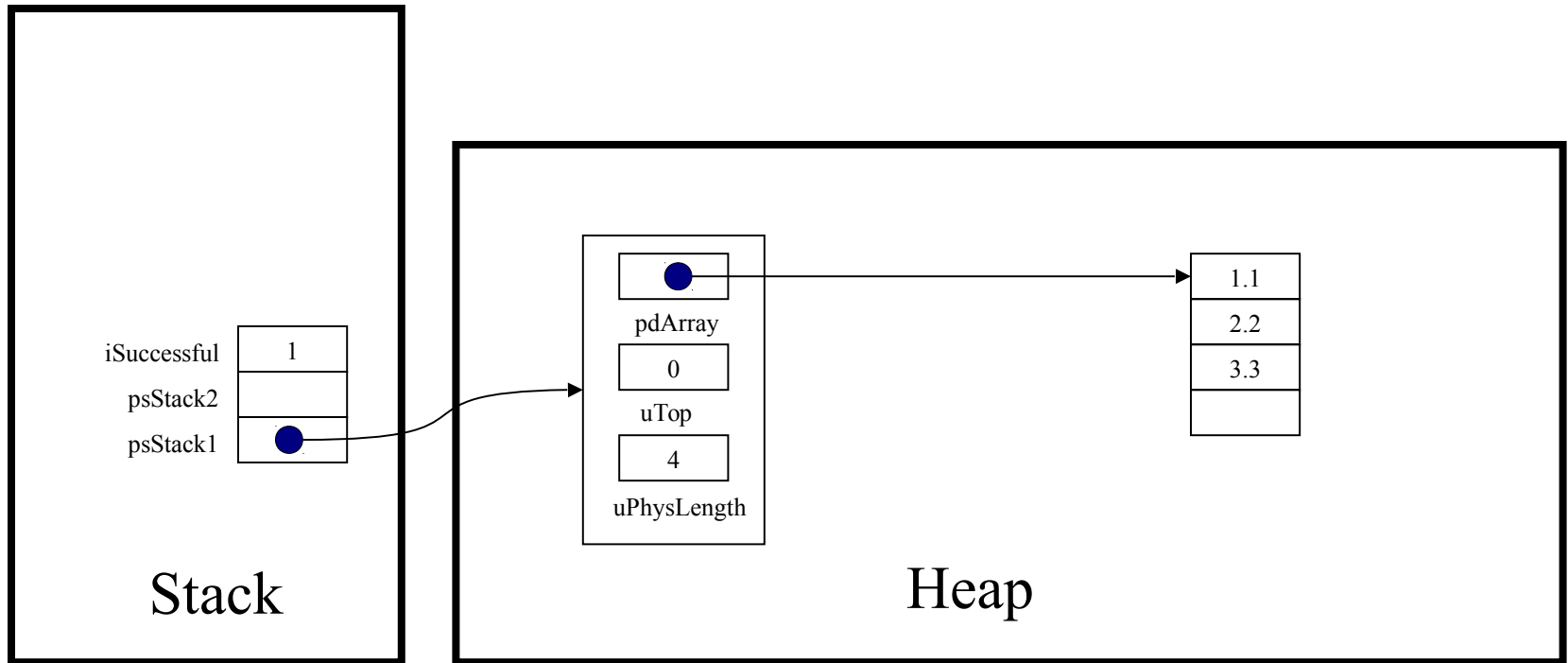

Princeton University
COS 217: Introduction to Programming Systems
Trace of teststack (Version 1)

```
int Stack_isEmpty(struct Stack *psStack)
```

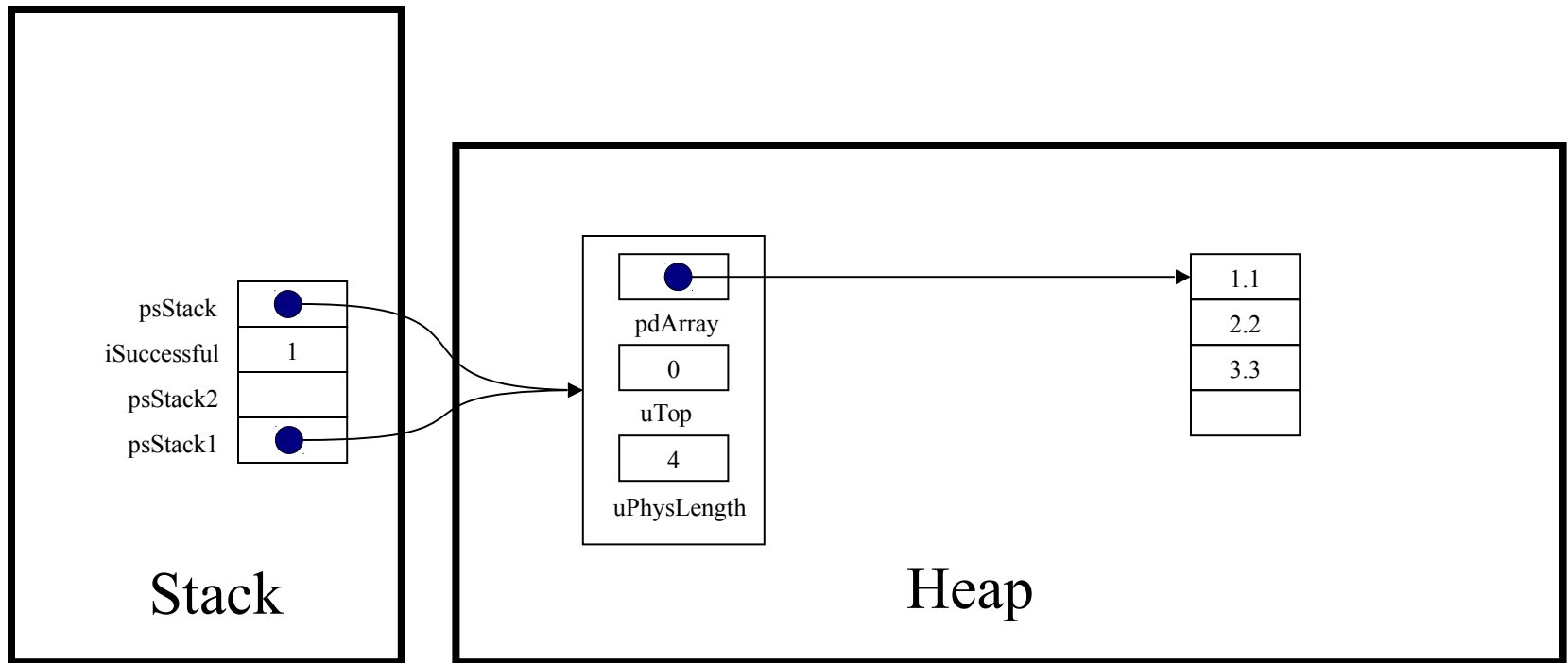

Princeton University
COS 217: Introduction to Programming Systems
Trace of teststack (Version 1)

```
assert (psStack != NULL);
```

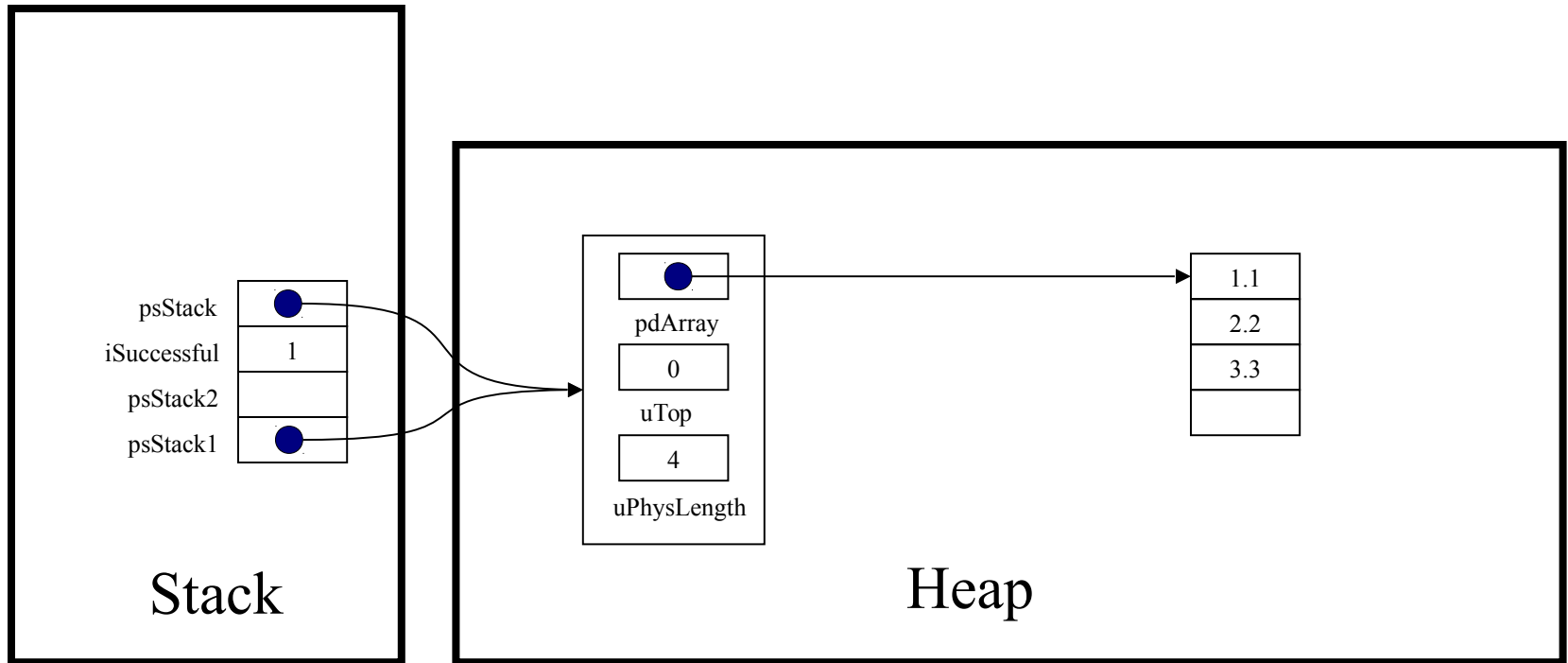

Princeton University
COS 217: Introduction to Programming Systems
Trace of teststack (Version 1)

```
return psStack->uTop == 0;
```

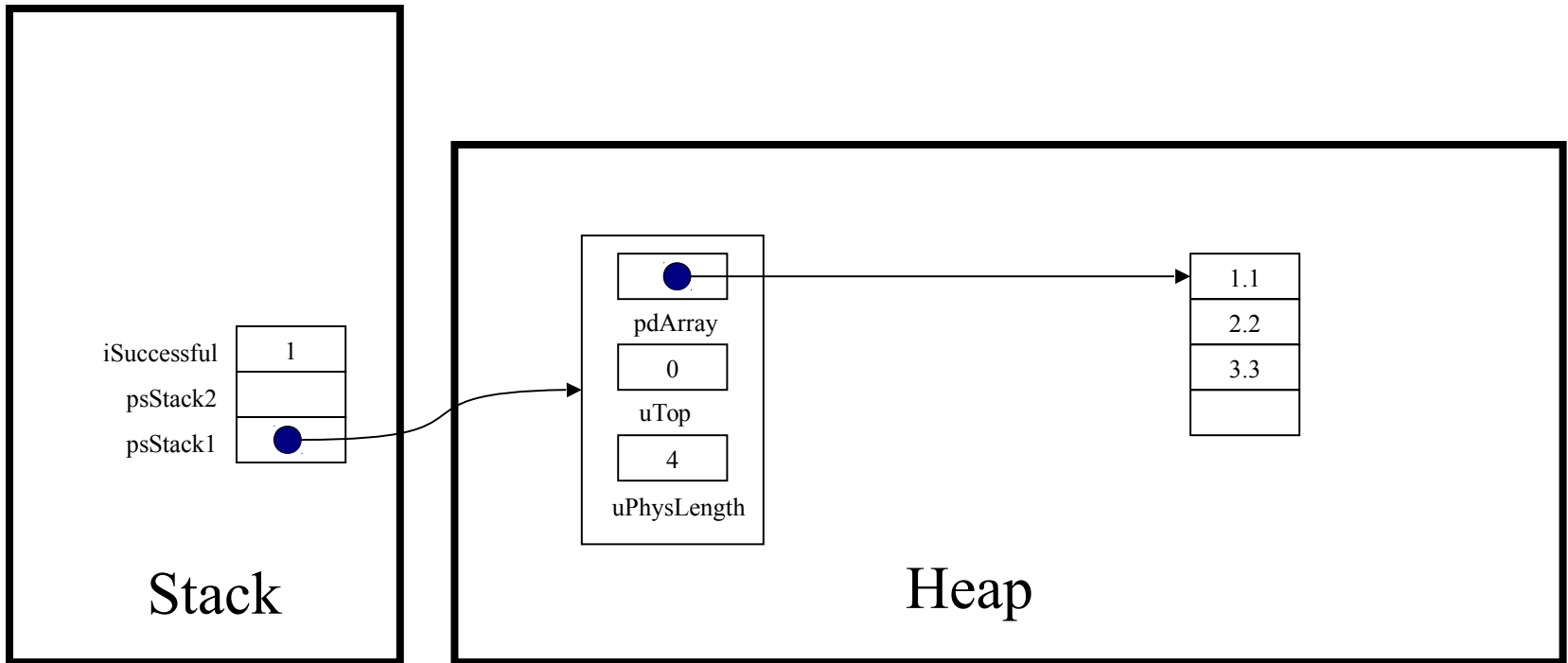

Princeton University
COS 217: Introduction to Programming Systems
Trace of teststack (Version 1)

```
while (! Stack_isEmpty(psStack1))
```

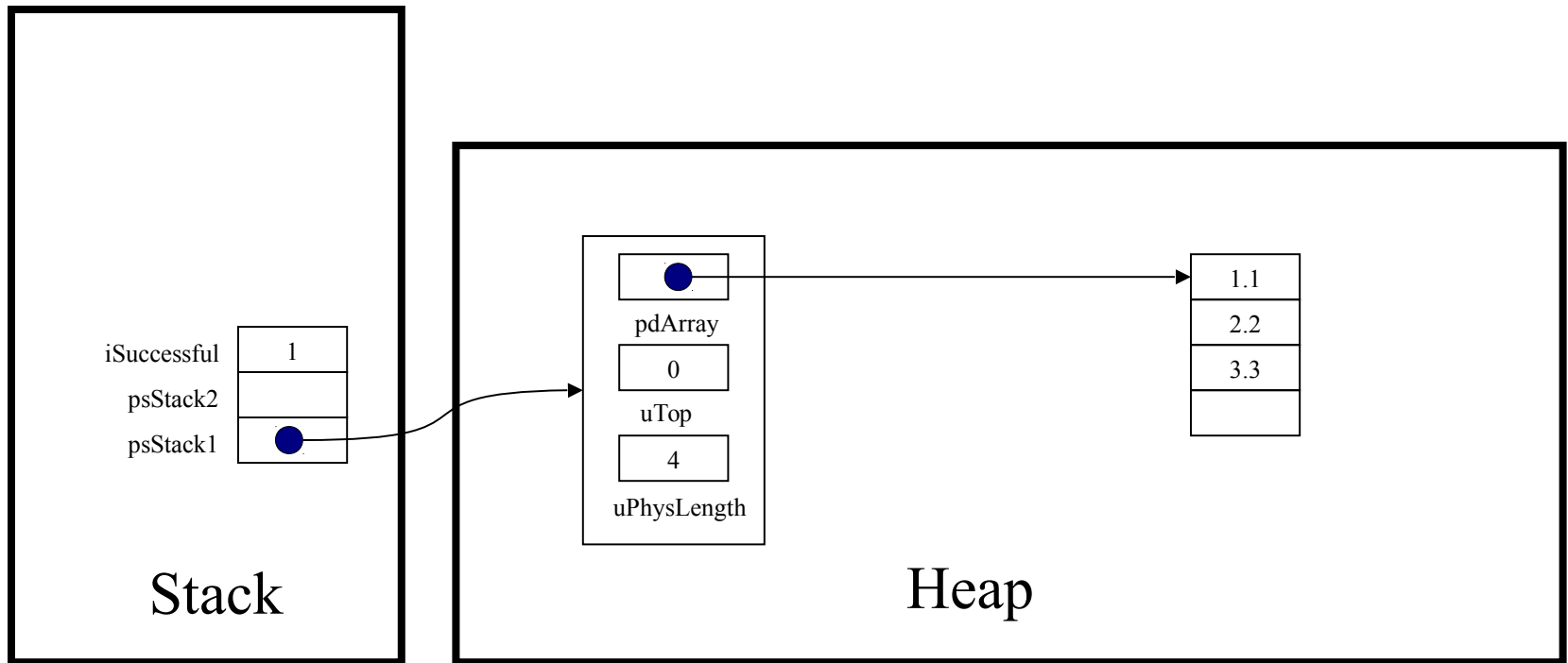

Princeton University
COS 217: Introduction to Programming Systems
Trace of teststack (Version 1)

```
Stack_free(psStack1);
```

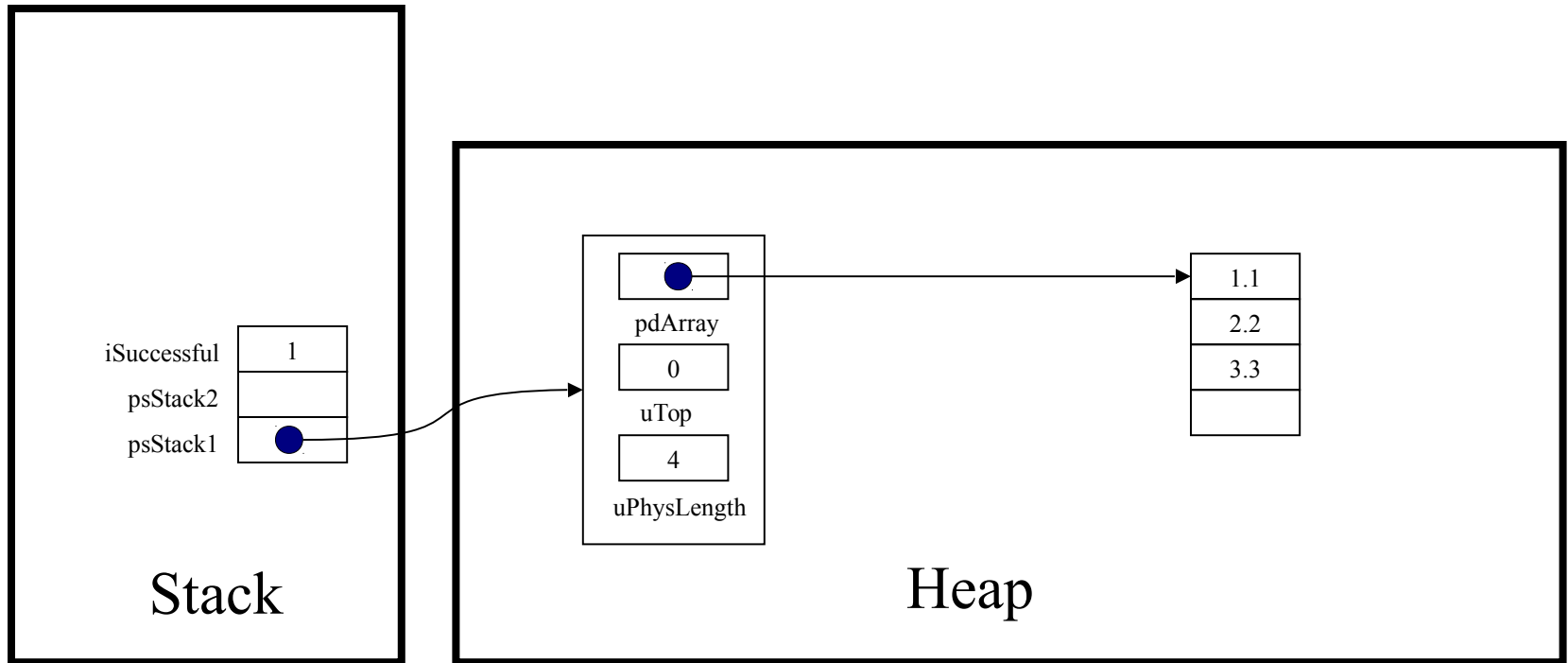

Princeton University
COS 217: Introduction to Programming Systems
Trace of teststack (Version 1)

```
void Stack_free(struct Stack *psStack)
```

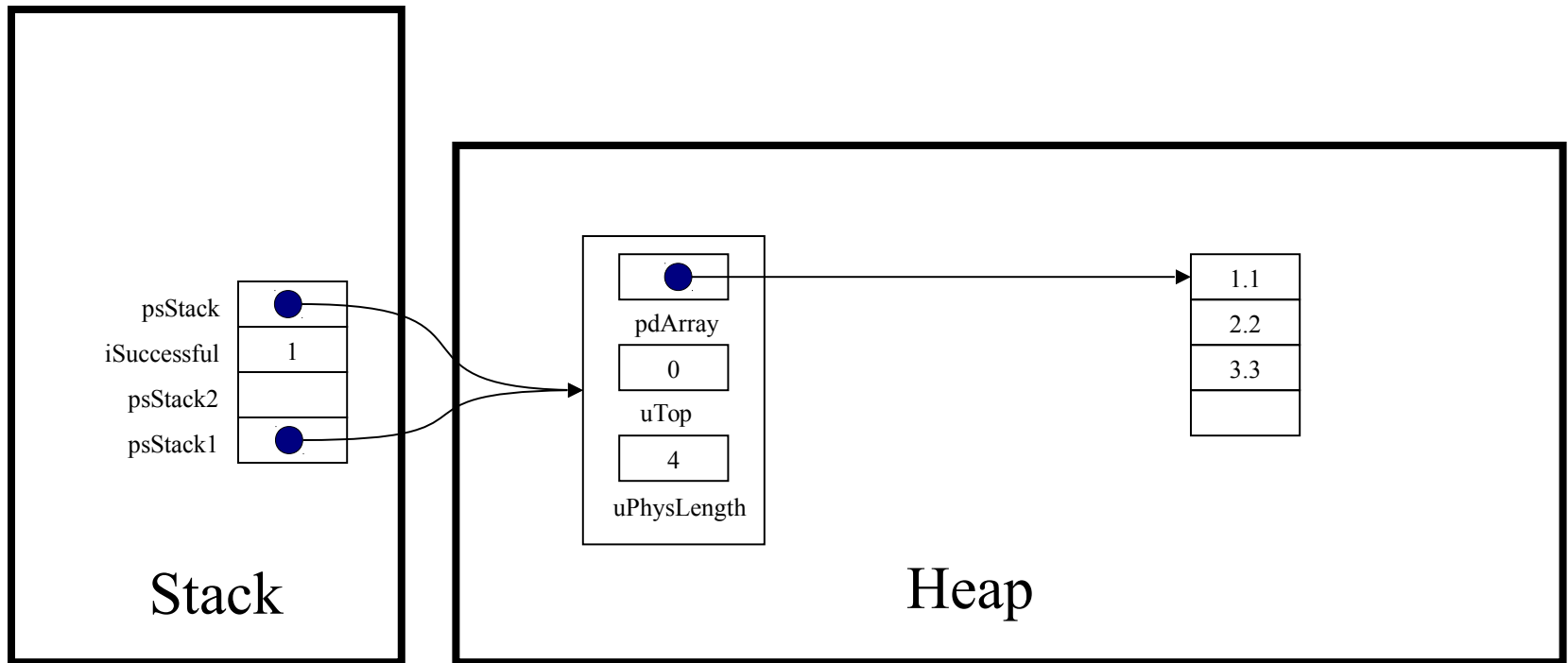

Princeton University
COS 217: Introduction to Programming Systems
Trace of teststack (Version 1)

```
assert (psStack != NULL);
```

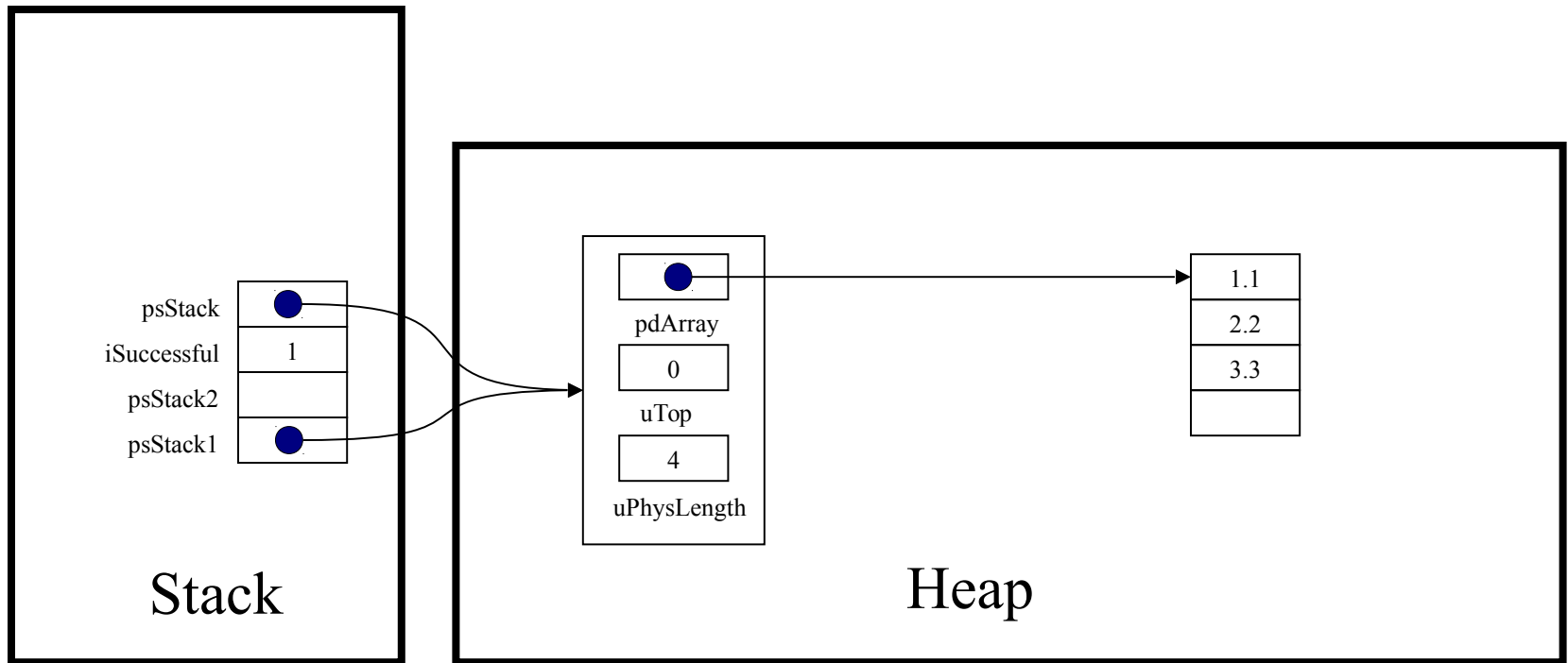

Princeton University
COS 217: Introduction to Programming Systems
Trace of teststack (Version 1)

```
free (psStack->pdArray);
```

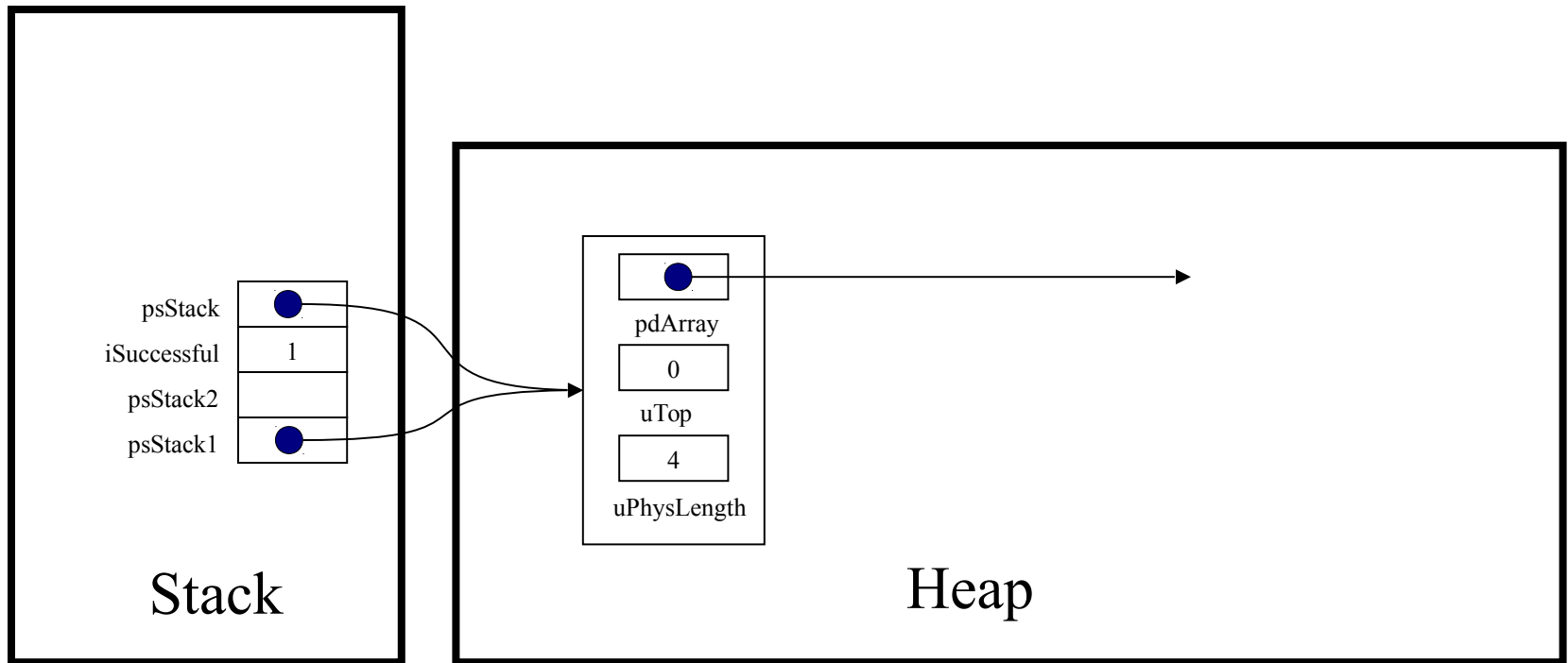

Princeton University
COS 217: Introduction to Programming Systems
Trace of teststack (Version 1)

```
free(psStack);
```

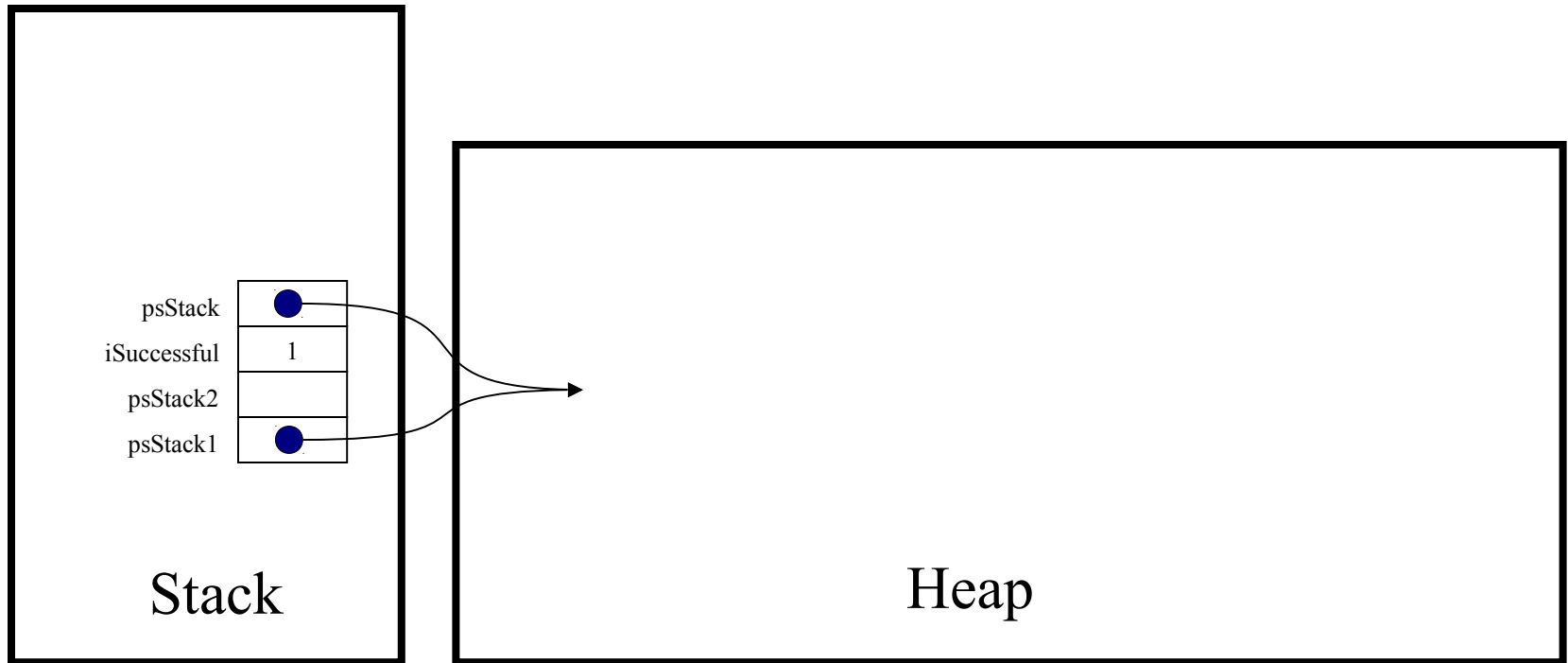

Princeton University
COS 217: Introduction to Programming Systems
Trace of teststack (Version 1)

Implicit return

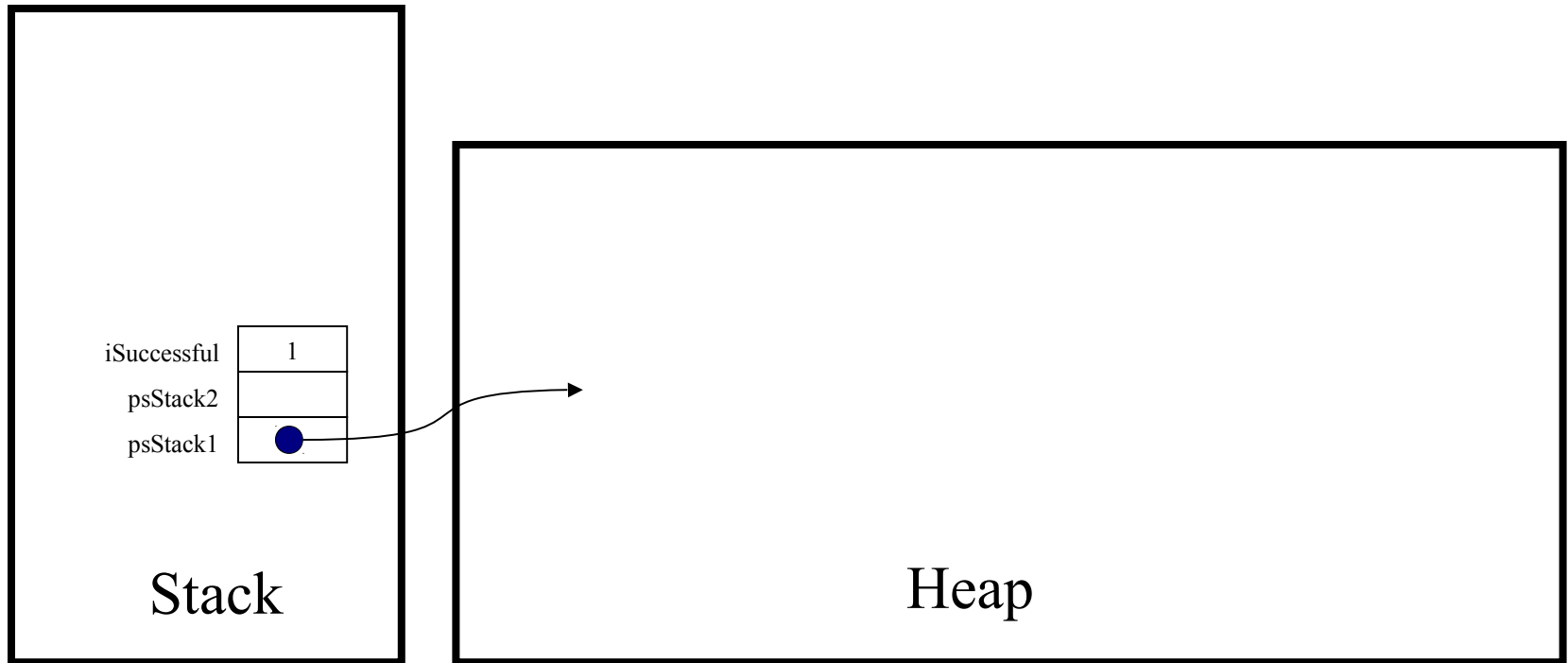

Princeton University
COS 217: Introduction to Programming Systems
Trace of teststack (Version 1)

```
psStack1 = NULL;
```

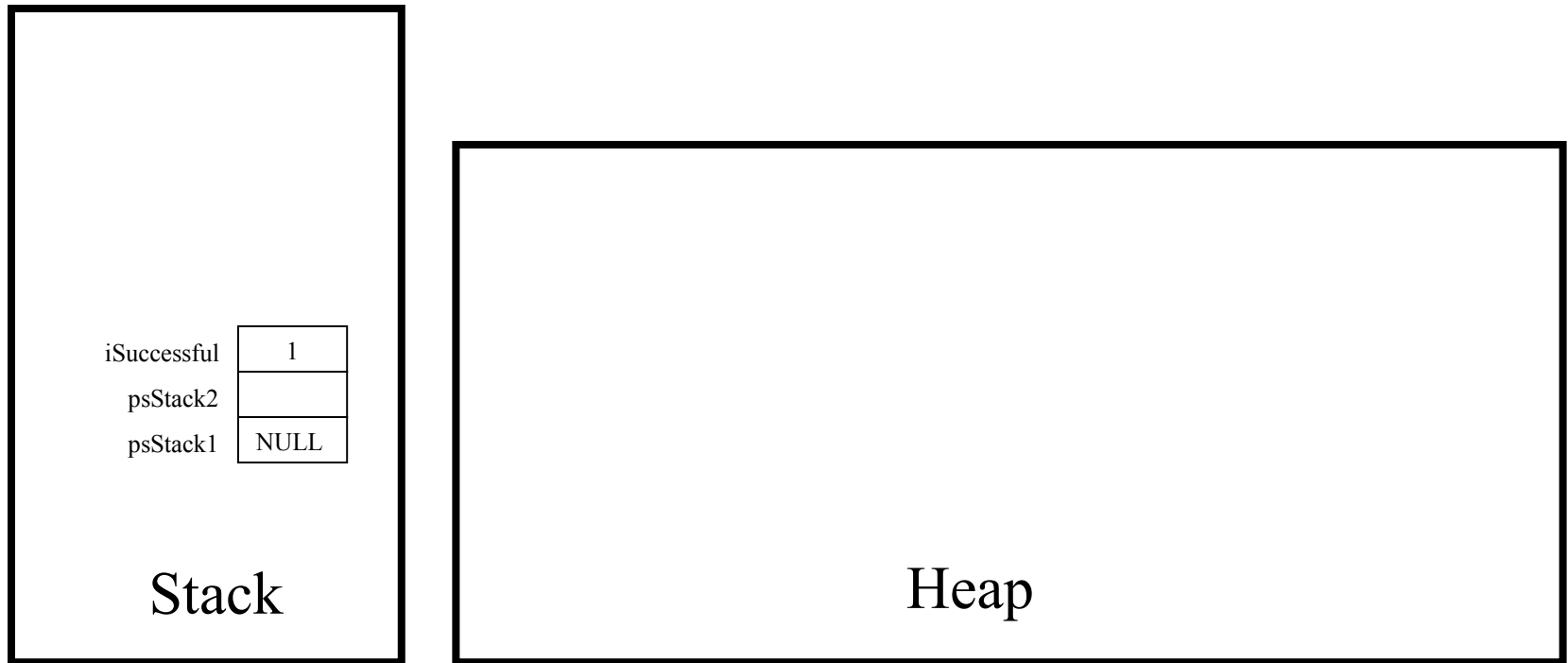

Princeton University
COS 217: Introduction to Programming Systems
Trace of teststack (Version 1)

```
psStack2 = Stack_new();
```

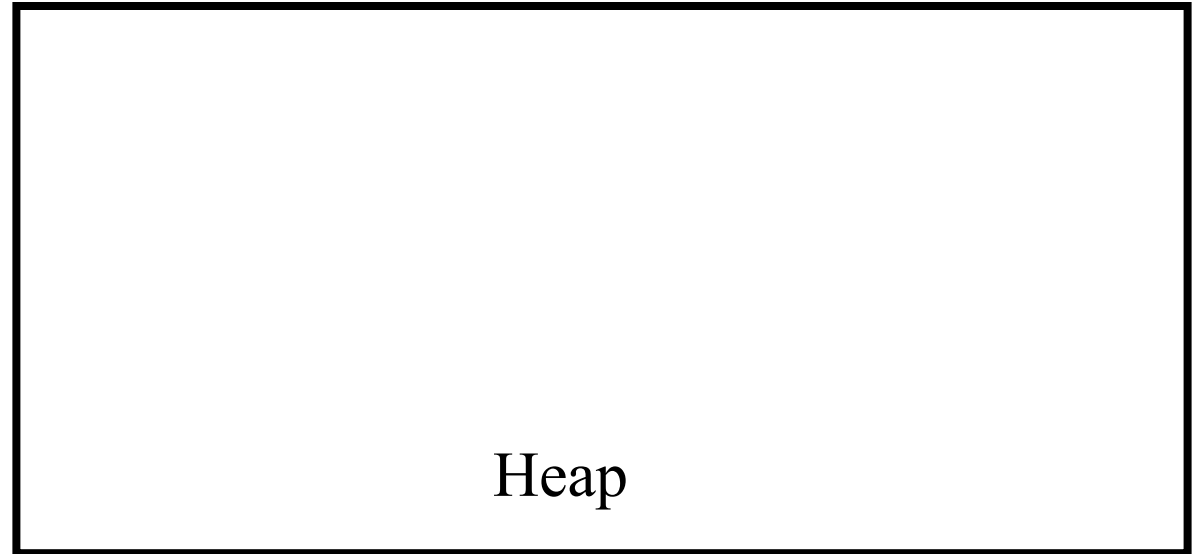
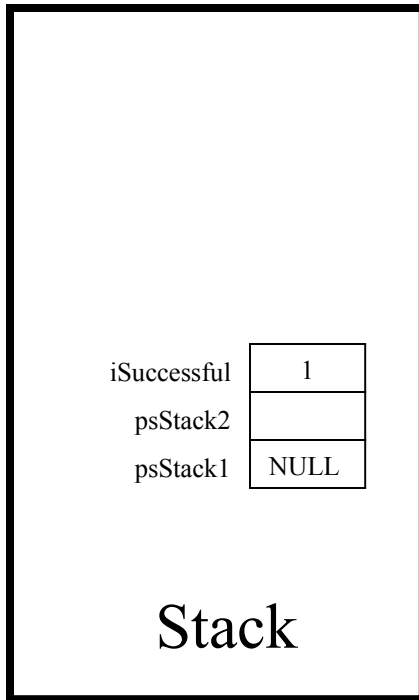

Princeton University
COS 217: Introduction to Programming Systems
Trace of teststack (Version 1)

```
struct Stack *psStack;
```

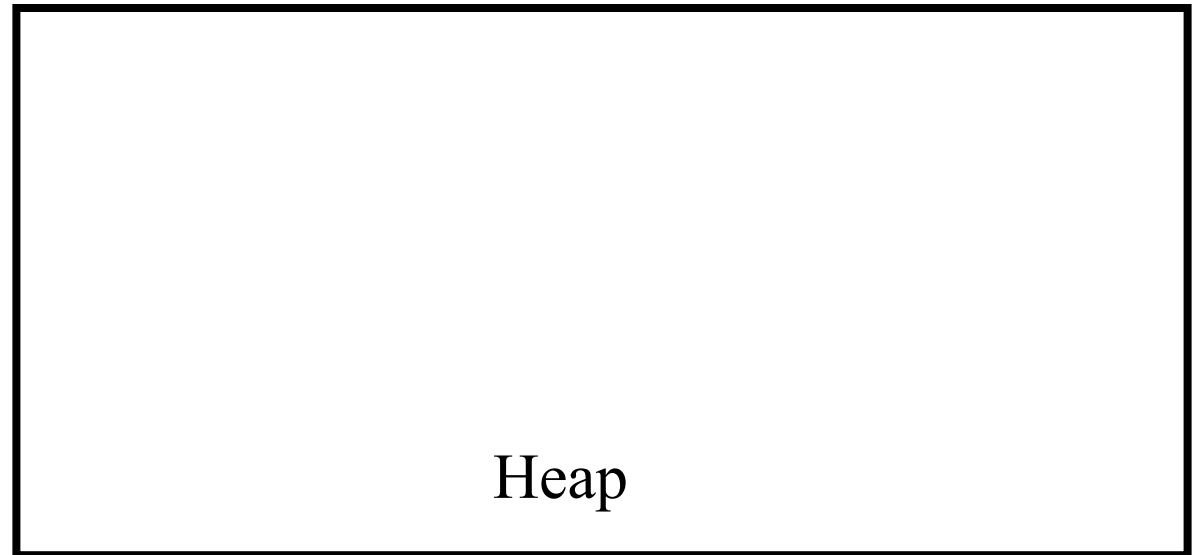
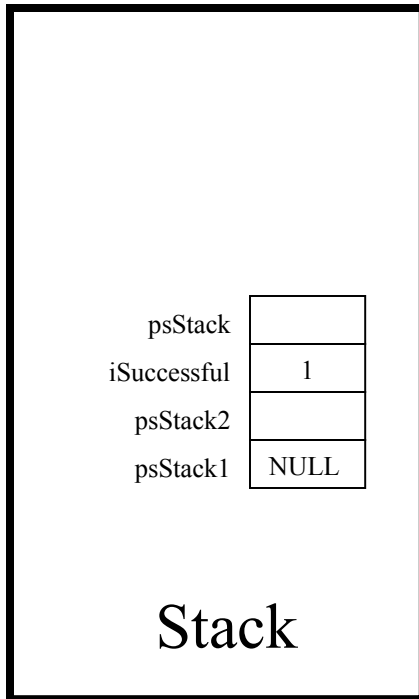

Princeton University
COS 217: Introduction to Programming Systems
Trace of teststack (Version 1)

```
psStack = (struct Stack*)malloc(sizeof(struct Stack));
```

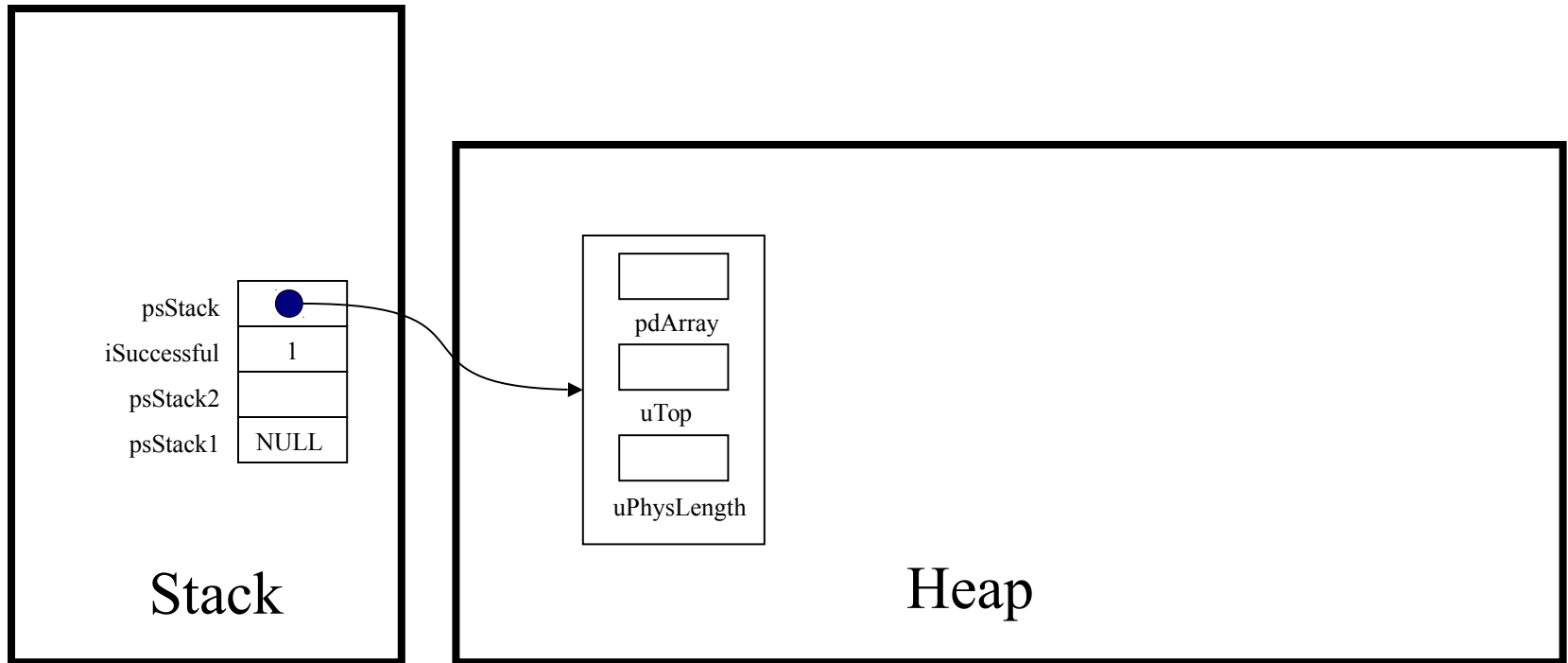

Princeton University
COS 217: Introduction to Programming Systems
Trace of teststack (Version 1)

```
if (psStack == NULL)  
    return NULL;
```

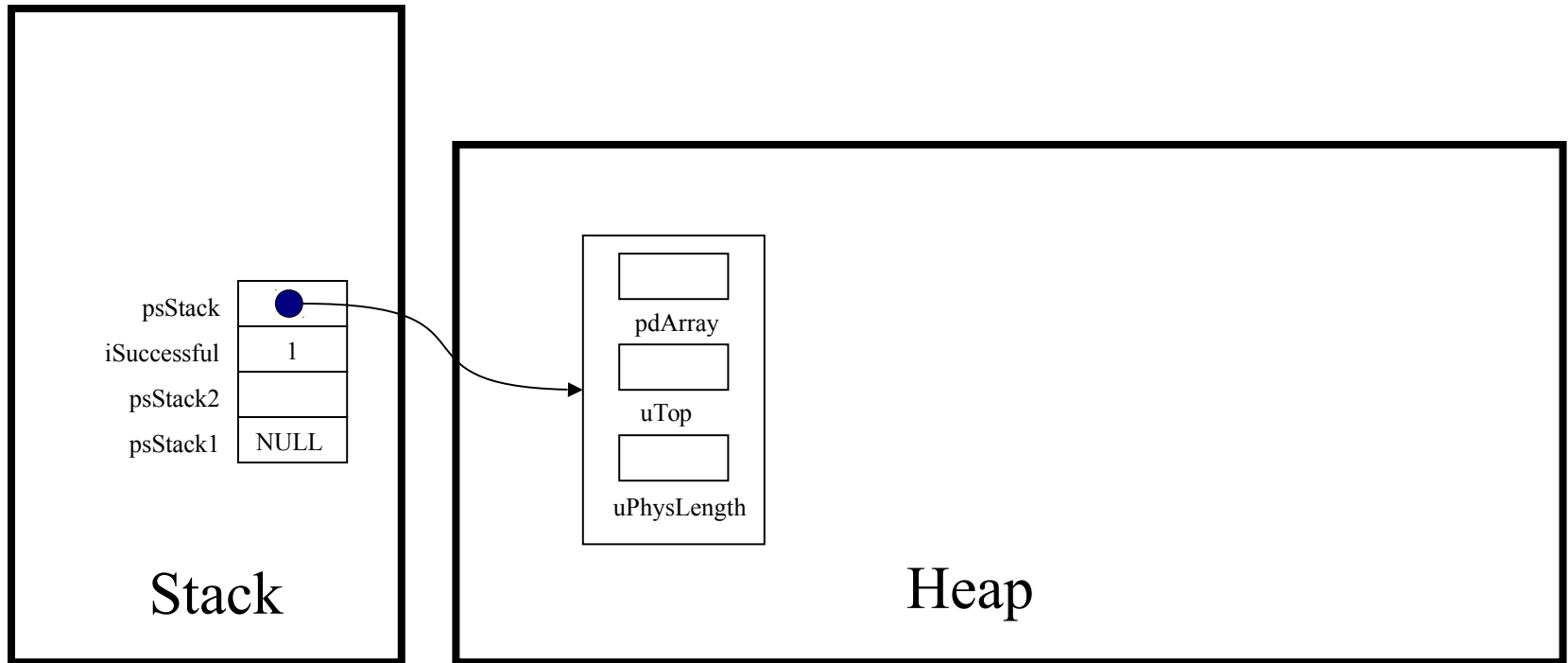

Princeton University
COS 217: Introduction to Programming Systems
Trace of teststack (Version 1)

```
psStack->pdArray = (double*)calloc(INITIAL_PHYS_LENGTH, sizeof(double));
```

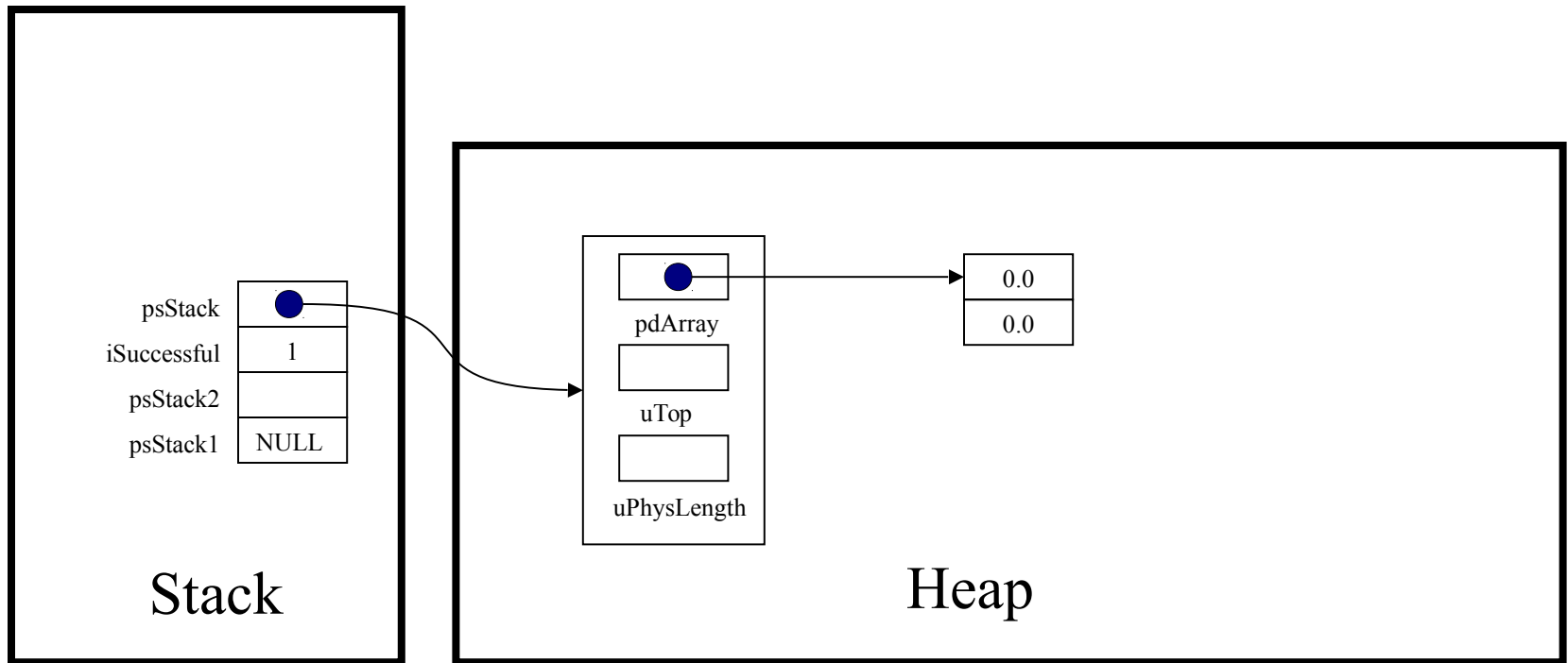

Princeton University
COS 217: Introduction to Programming Systems
Trace of teststack (Version 1)

```
if (psStack->pdArray == NULL)
{
    free(psStack);
    return NULL;
}
```

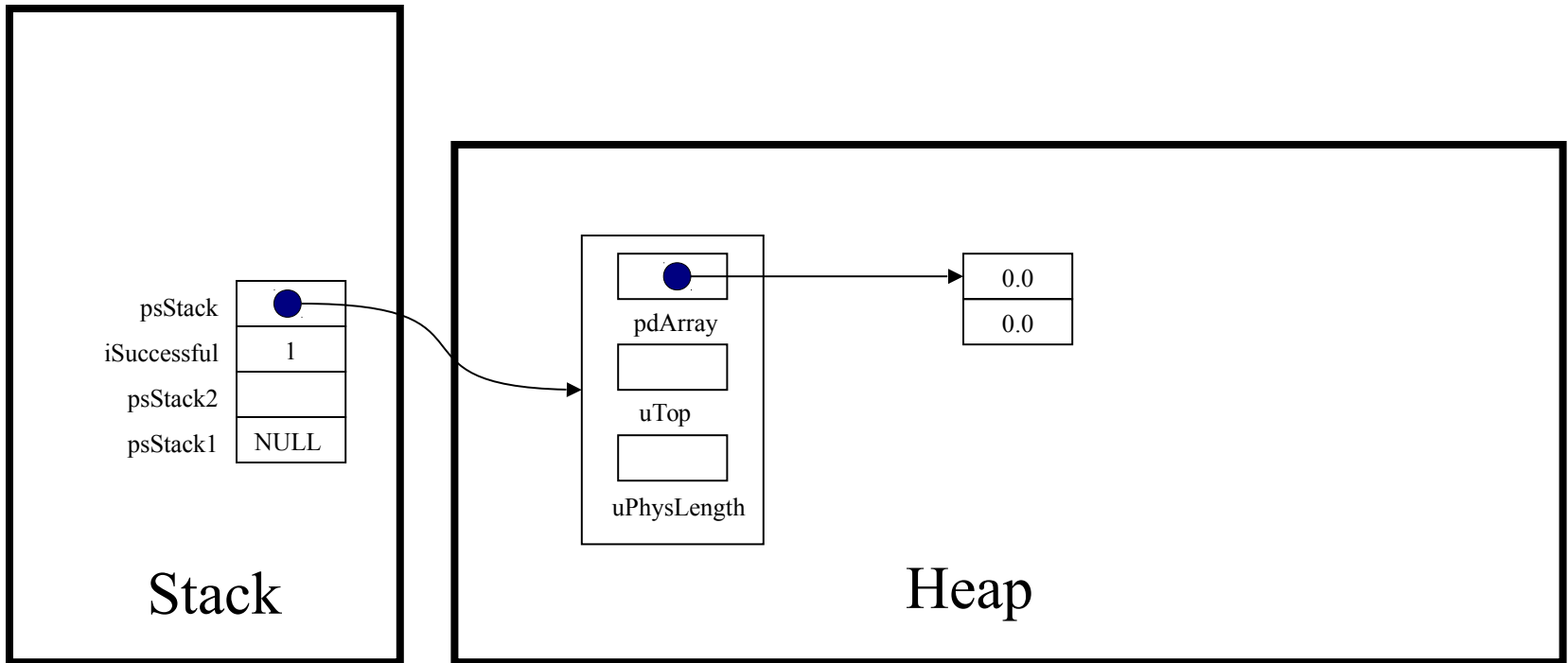

Princeton University
COS 217: Introduction to Programming Systems
Trace of teststack (Version 1)

```
psStack->uTop = 0;
```

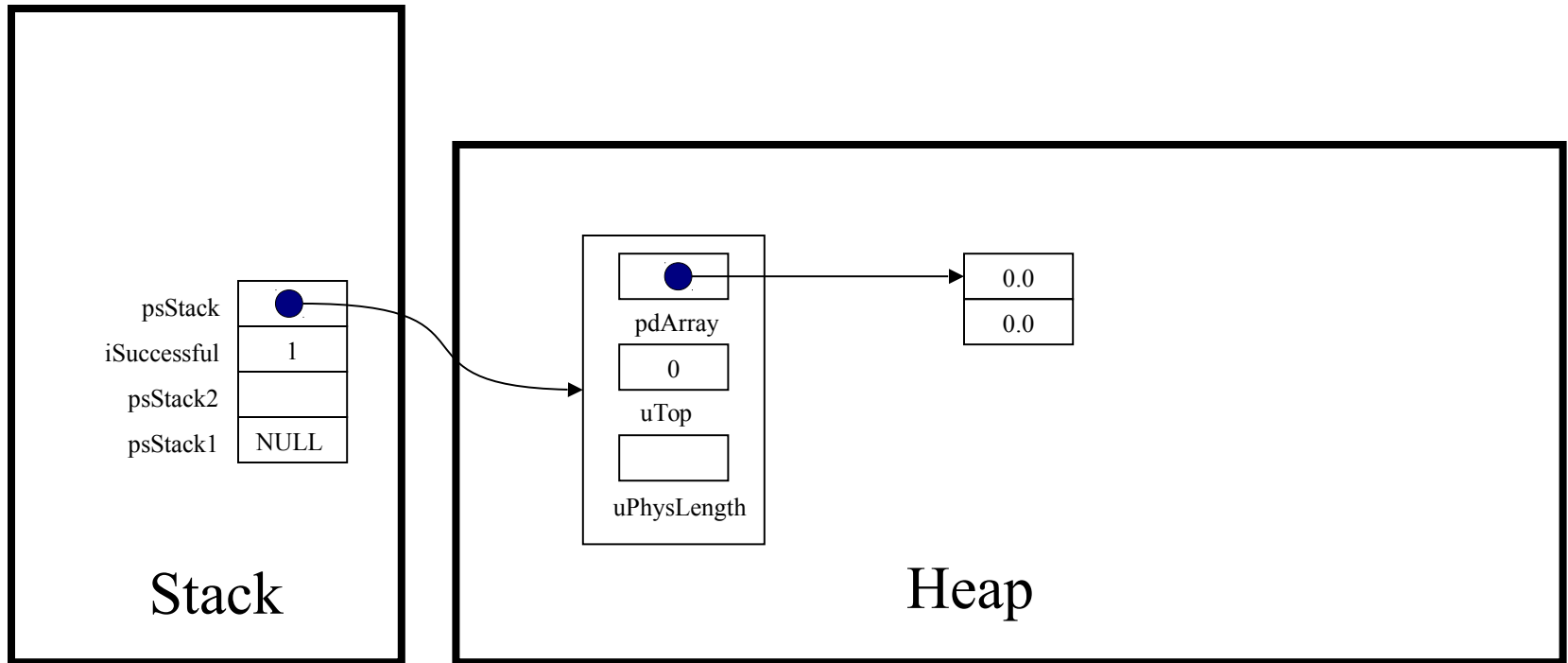

Princeton University
COS 217: Introduction to Programming Systems
Trace of teststack (Version 1)

```
psStack->uPhysLength = INITIAL_PHYS_LENGTH;
```

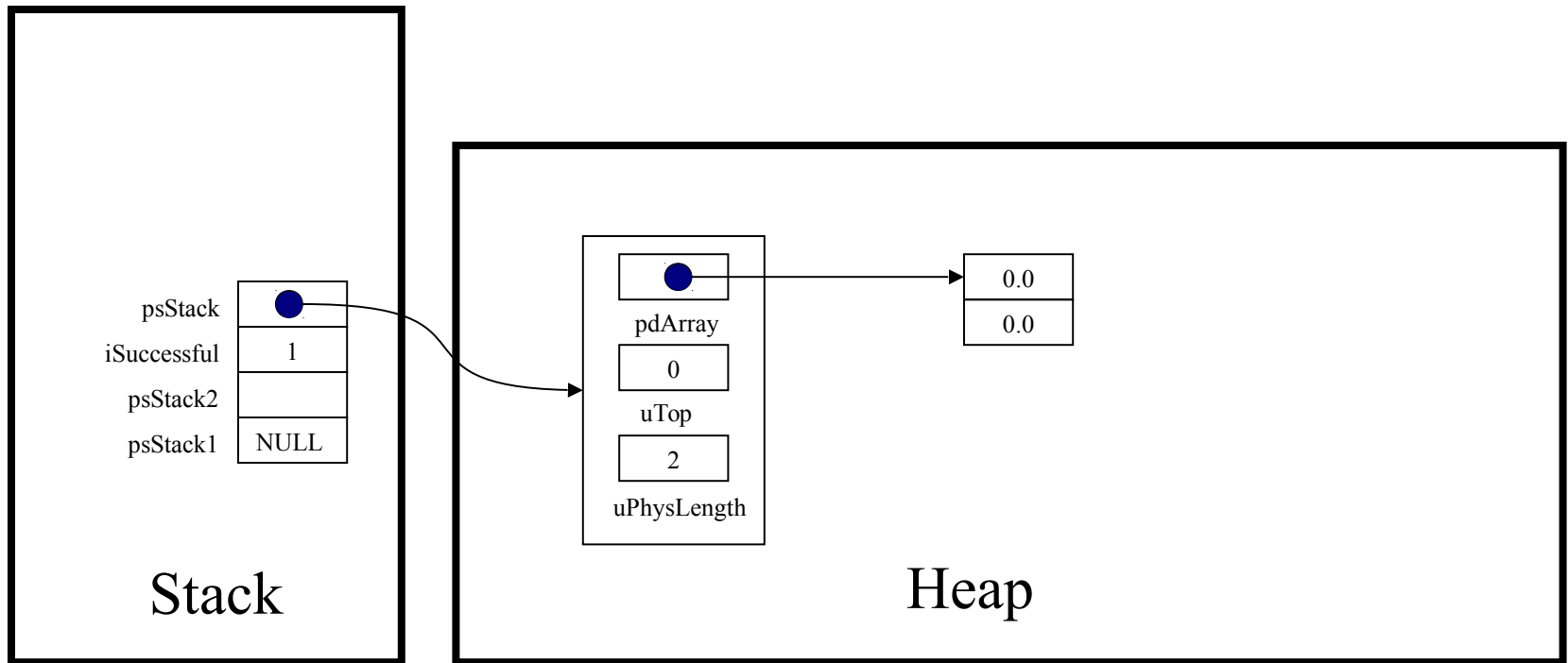

Princeton University
COS 217: Introduction to Programming Systems
Trace of teststack (Version 1)

```
return psStack;
```

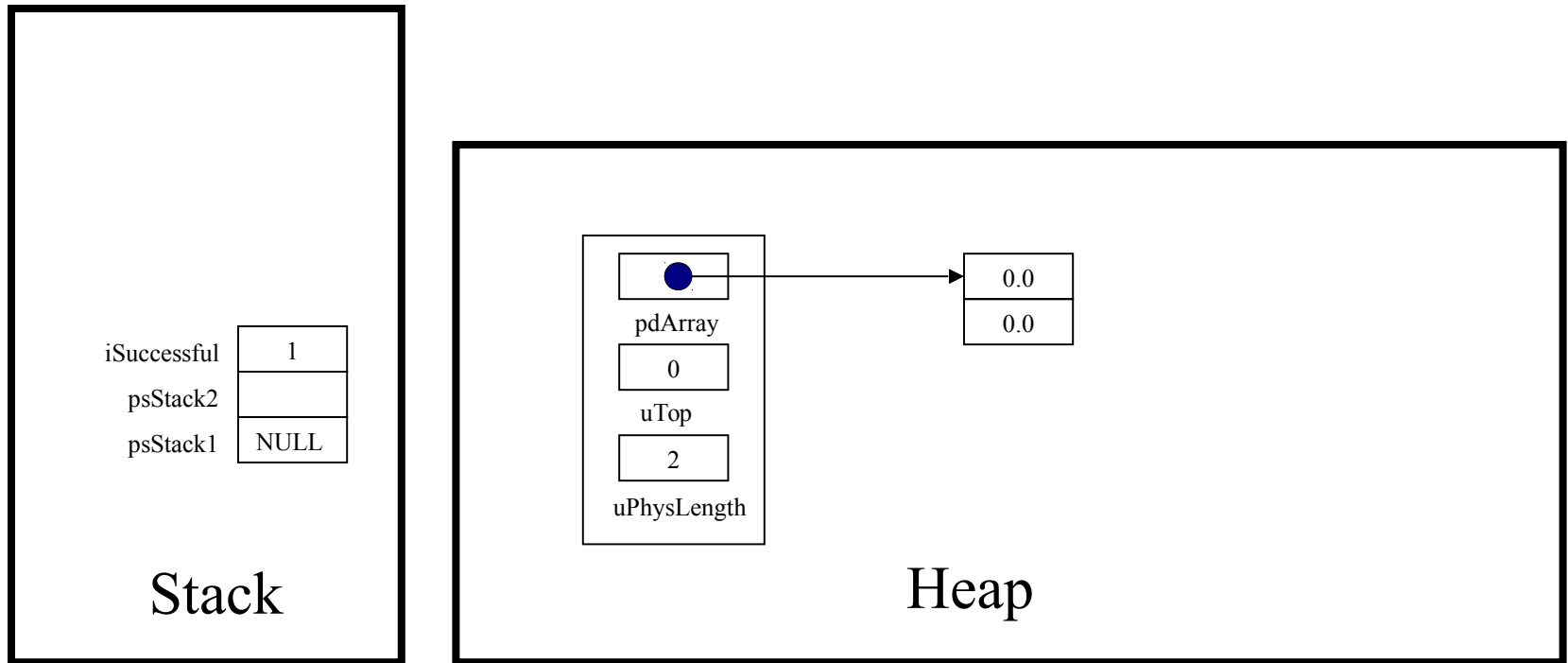

Princeton University
COS 217: Introduction to Programming Systems
Trace of teststack (Version 1)

```
psStack2 = Stack_new();
```

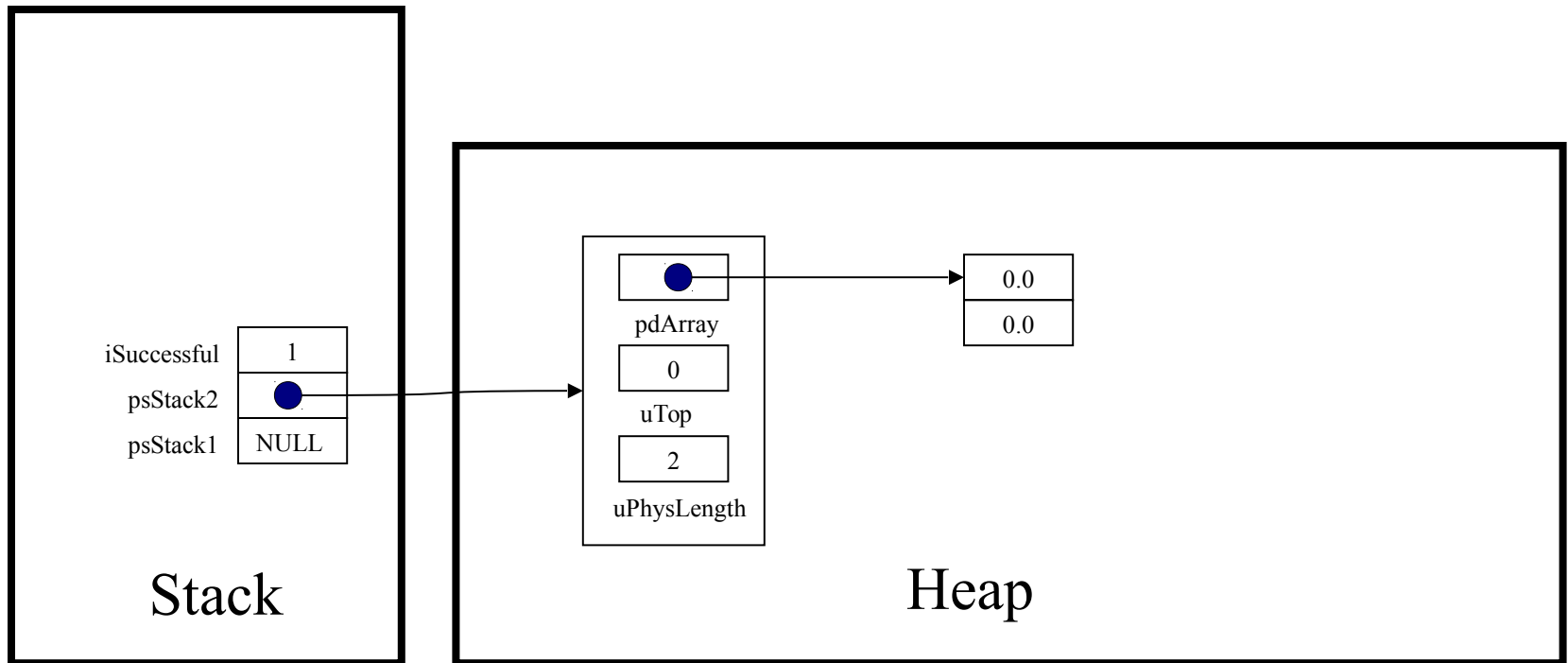

Princeton University
COS 217: Introduction to Programming Systems
Trace of teststack (Version 1)

```
if (psStack2 == NULL) handleMemoryError();
```

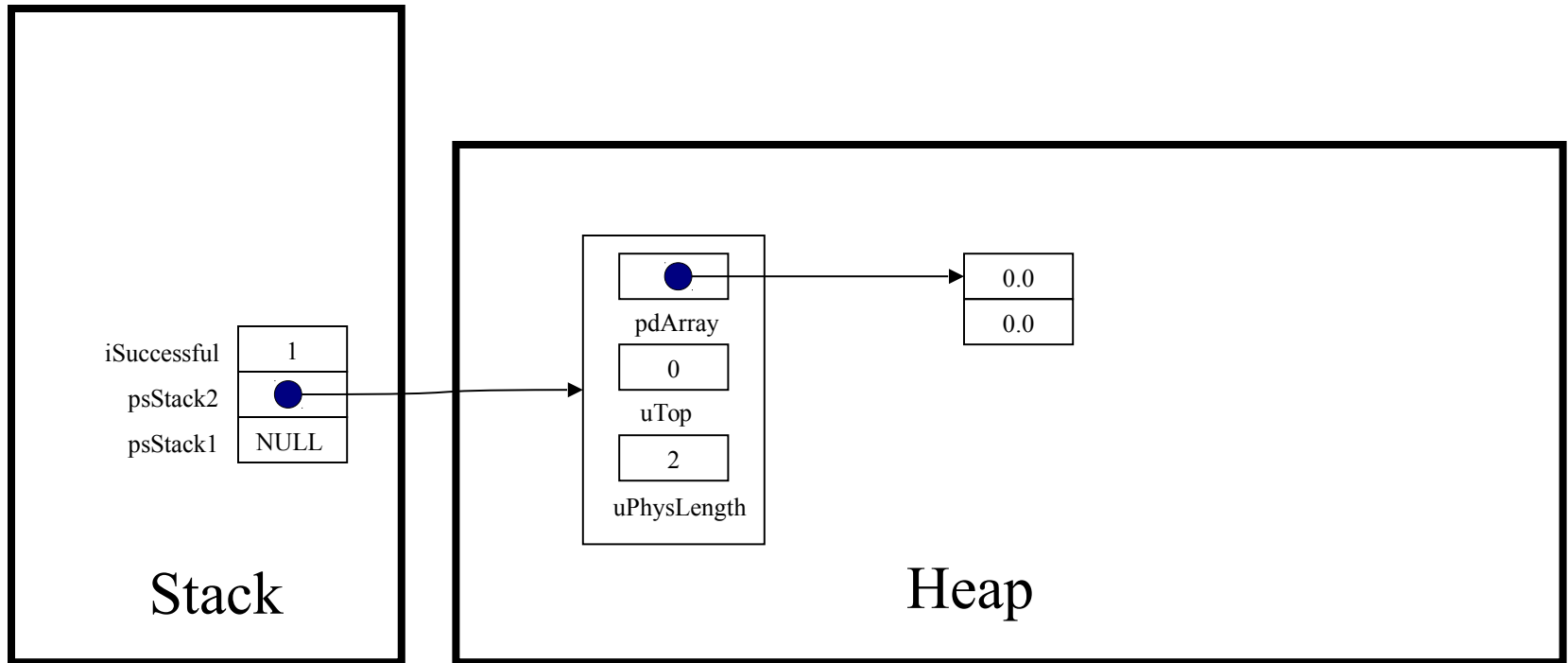

Princeton University
COS 217: Introduction to Programming Systems
Trace of teststack (Version 1)

```
iSuccessful = Stack_push(psStack2, 4.4);
```

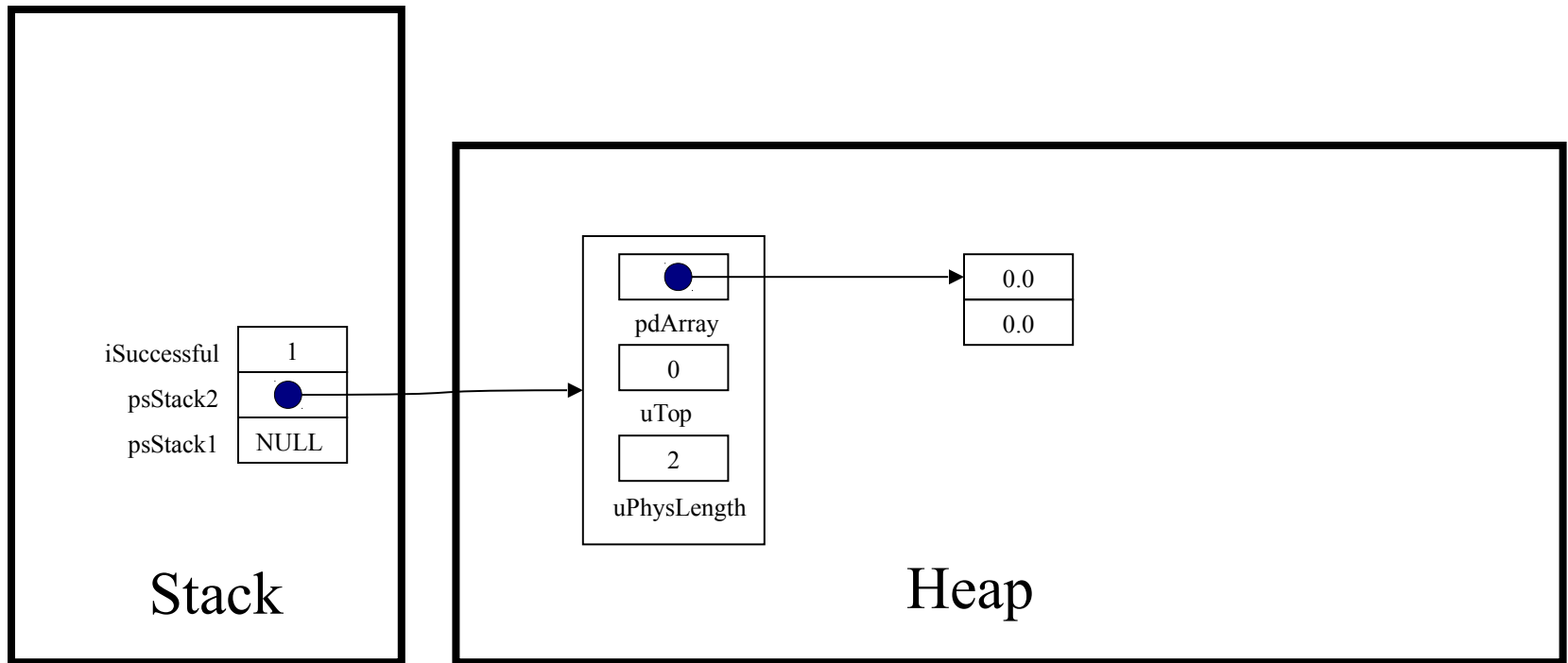

Princeton University
COS 217: Introduction to Programming Systems
Trace of teststack (Version 1)

```
int Stack_push(struct Stack *psStack, double dItem)
```

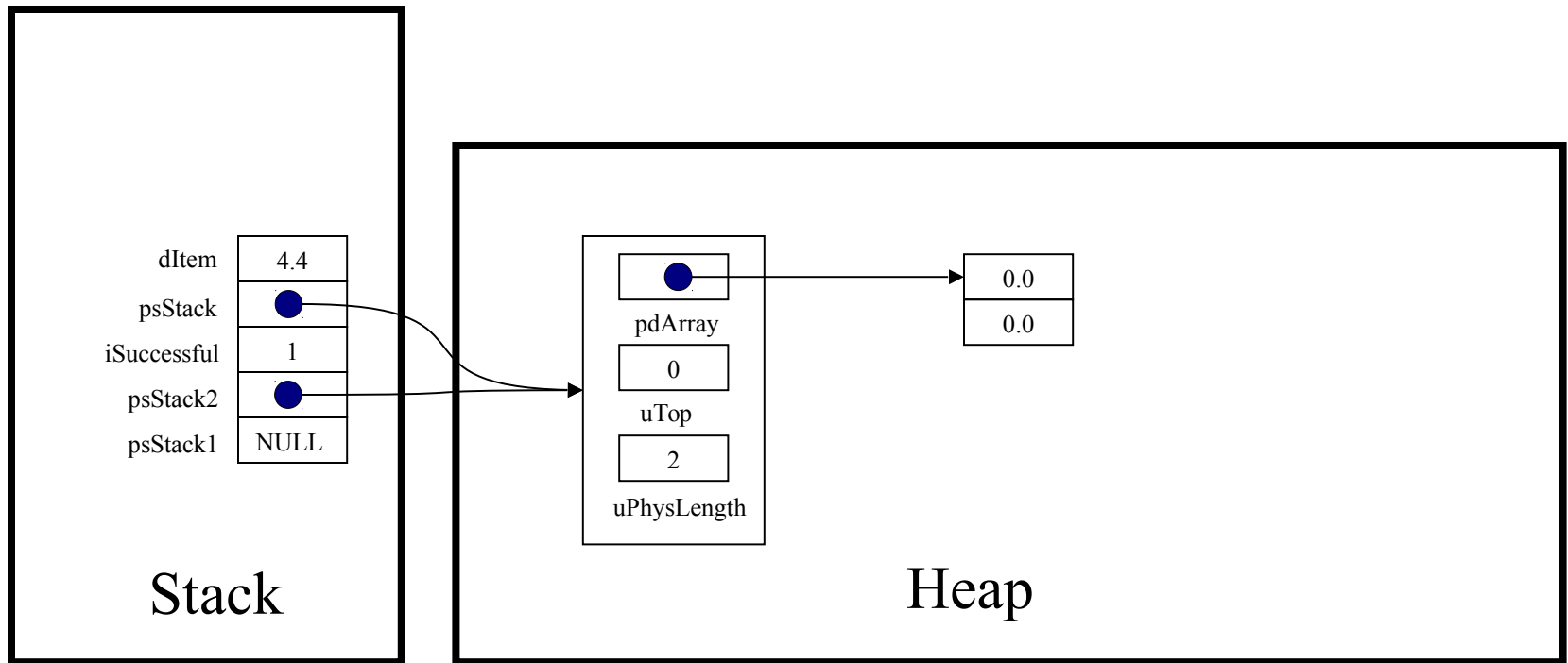

Princeton University
COS 217: Introduction to Programming Systems
Trace of teststack (Version 1)

```
int iSuccessful;
```

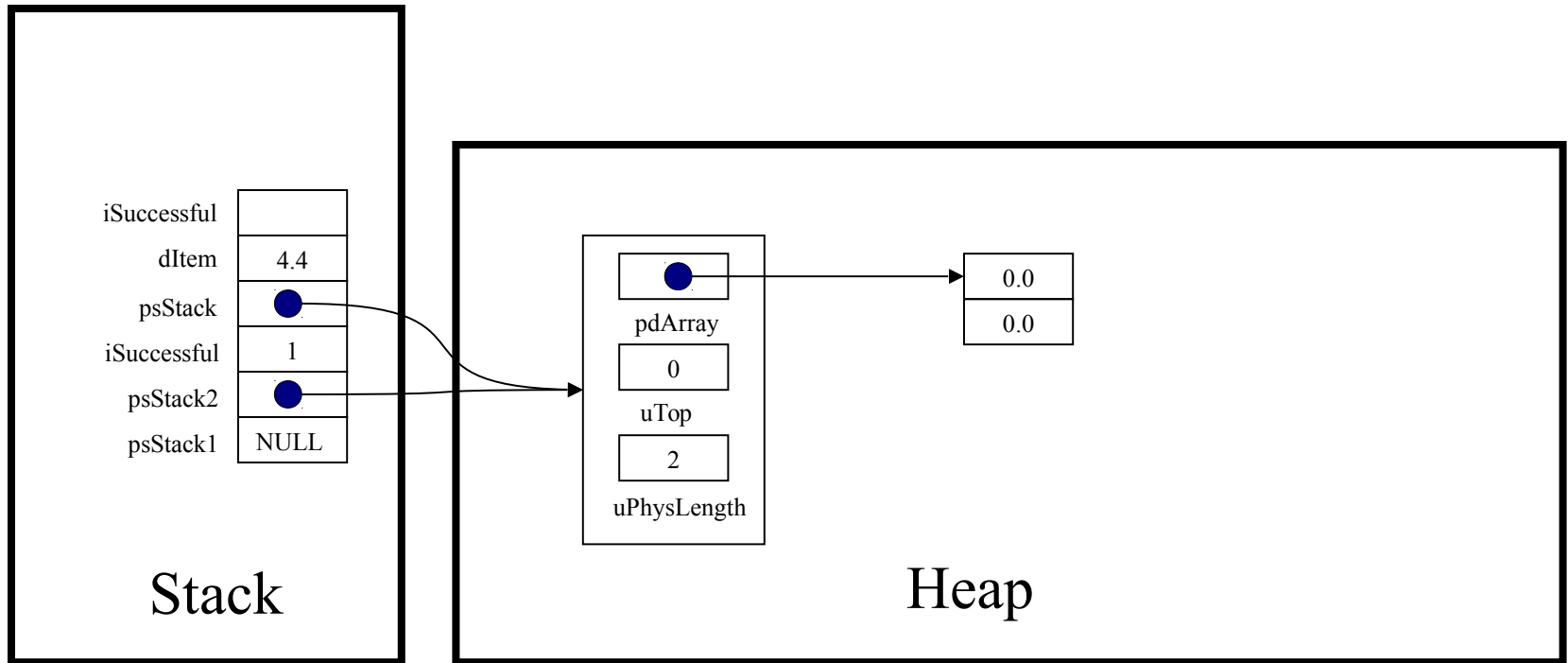

Princeton University
COS 217: Introduction to Programming Systems
Trace of teststack (Version 1)

```
assert (psStack != NULL);
```

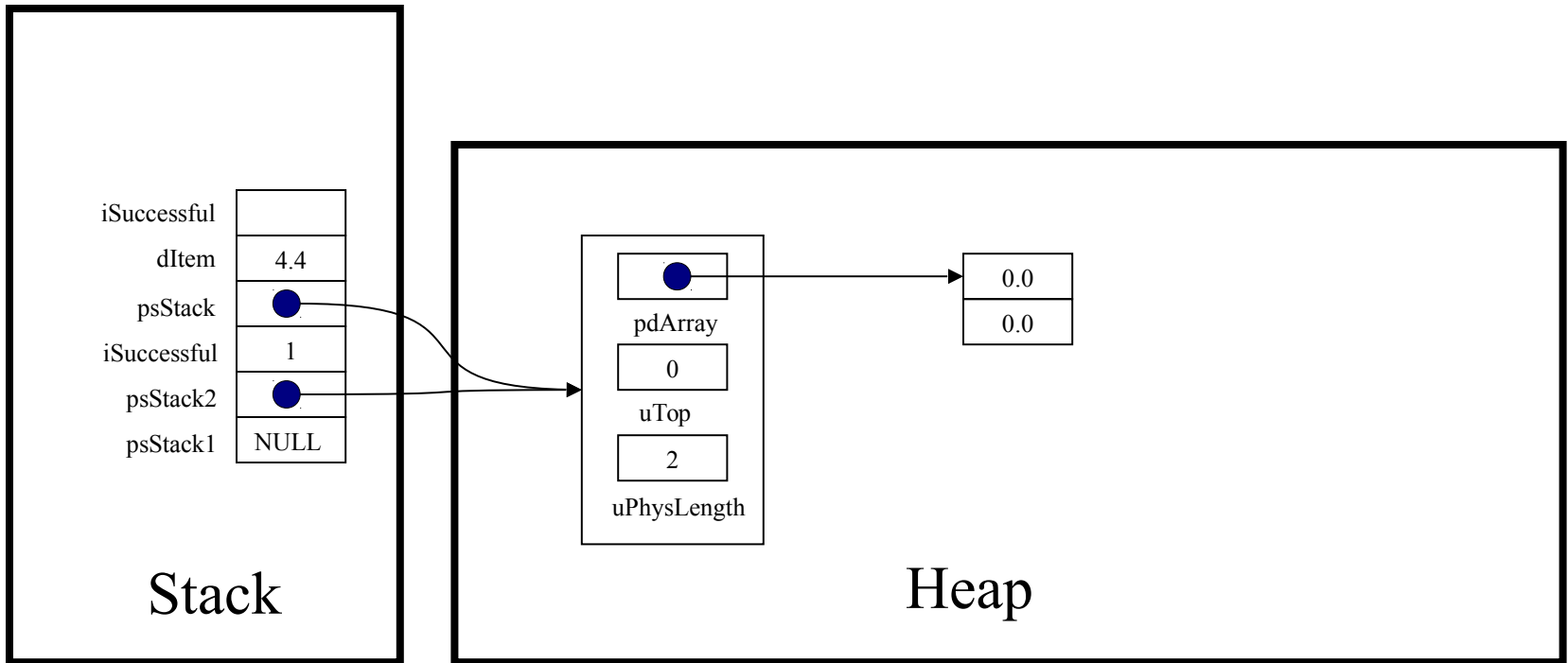

Princeton University
COS 217: Introduction to Programming Systems
Trace of teststack (Version 1)

```
if (psStack->uTop == psStack->uPhysLength)  
...
```

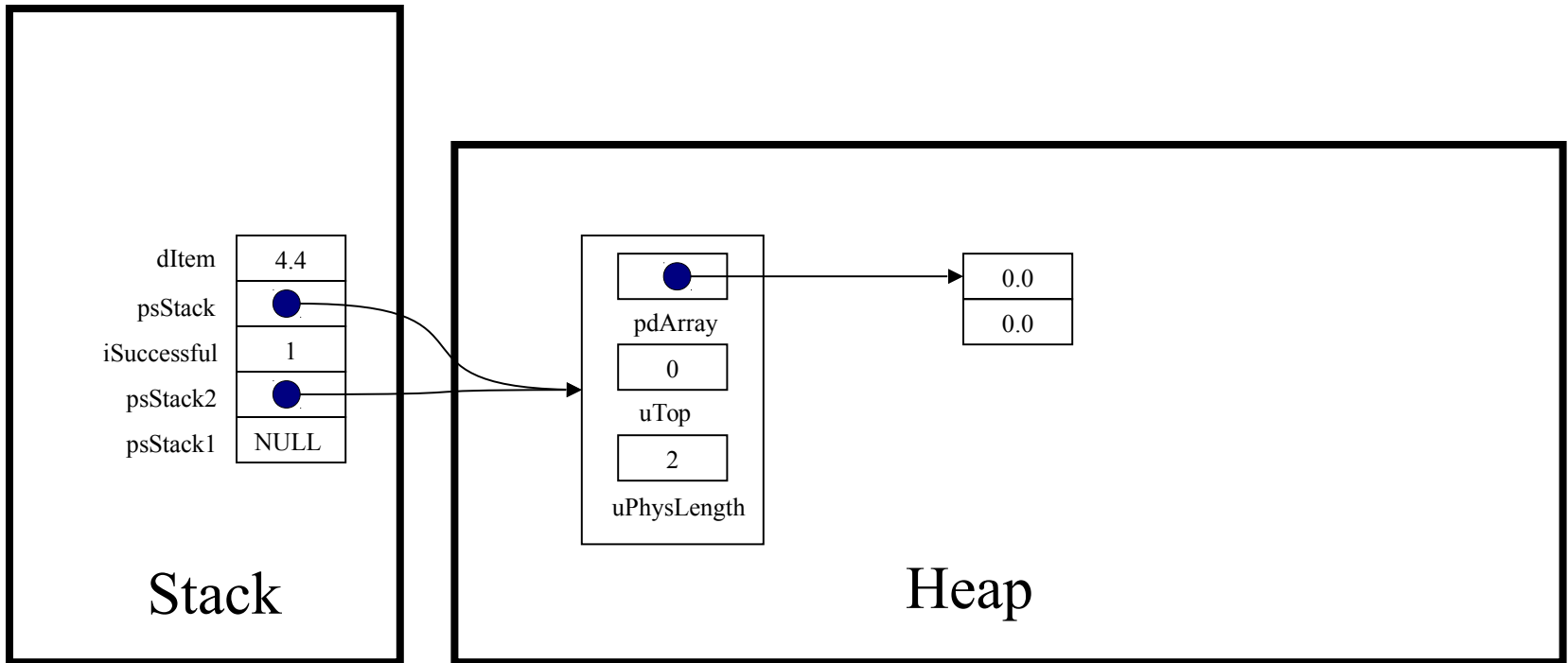

Princeton University
COS 217: Introduction to Programming Systems
Trace of teststack (Version 1)

```
(psStack->pdArray)[psStack->uTop] = dItem;
```

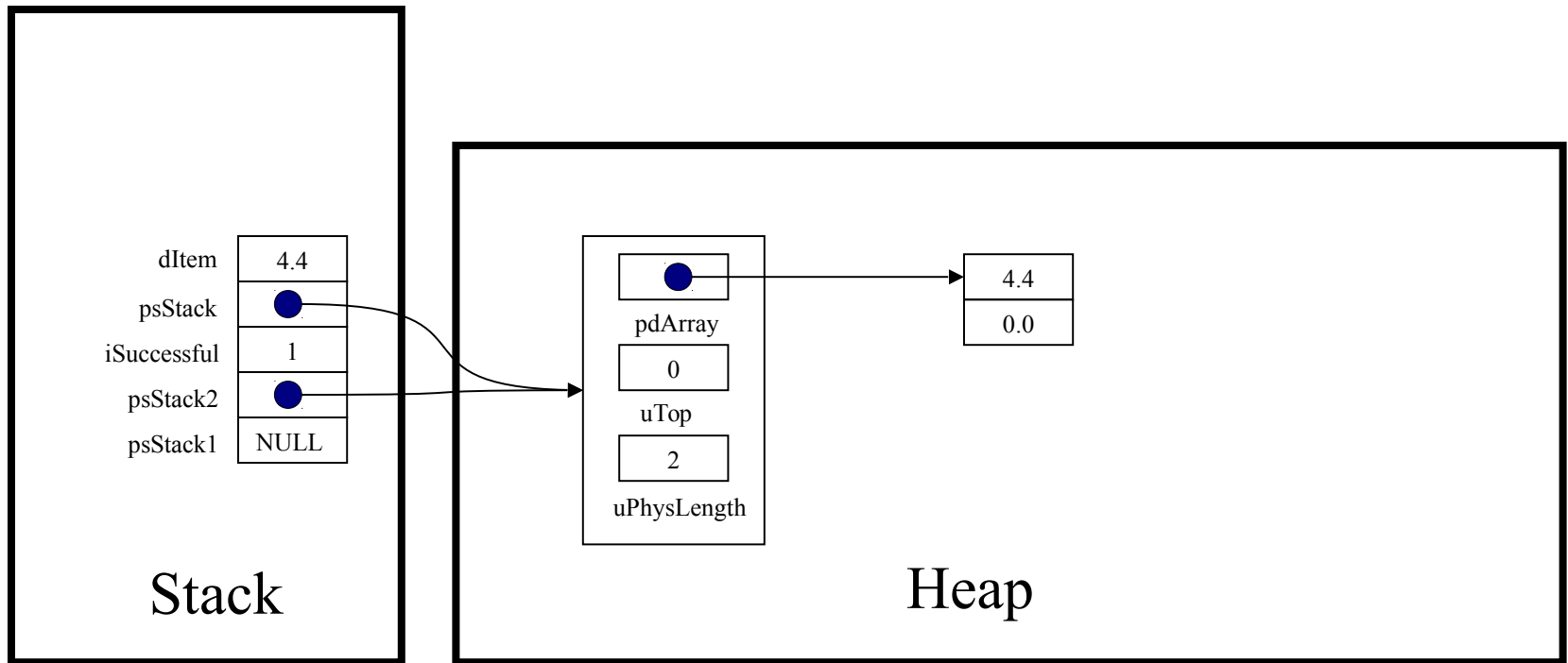

Princeton University
COS 217: Introduction to Programming Systems
Trace of teststack (Version 1)

```
(psStack->uTop) ++;
```

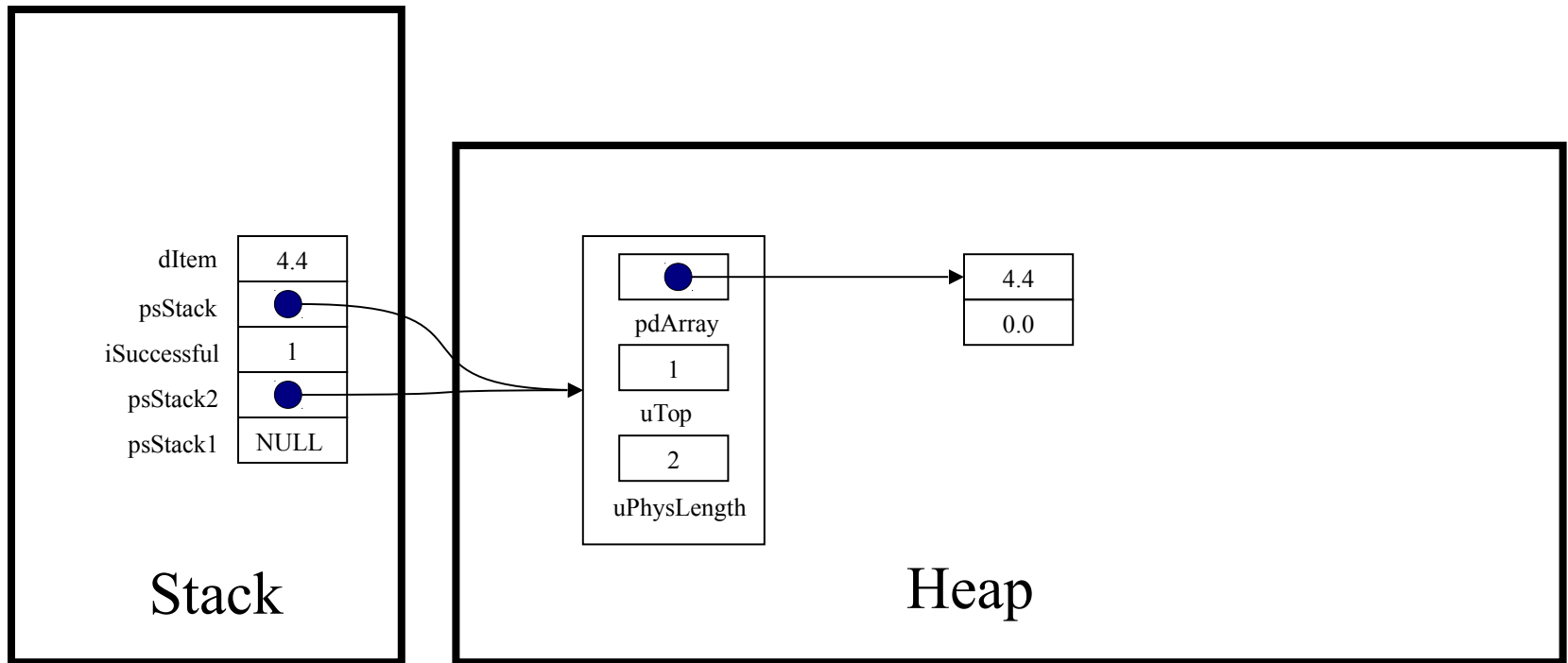

Princeton University
COS 217: Introduction to Programming Systems
Trace of teststack (Version 1)

```
return 1;
```

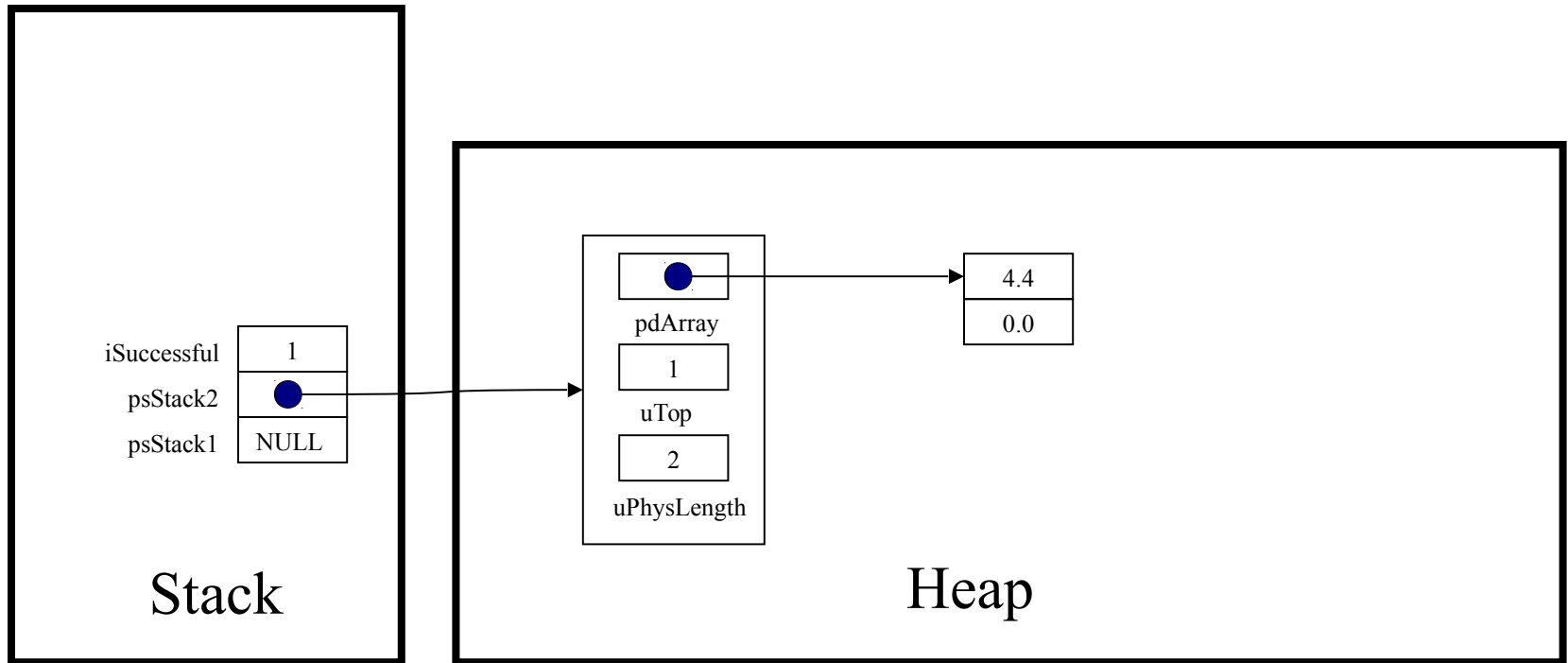

Princeton University
COS 217: Introduction to Programming Systems
Trace of teststack (Version 1)

```
iSuccessful = Stack_push(psStack2, 4.4);
```

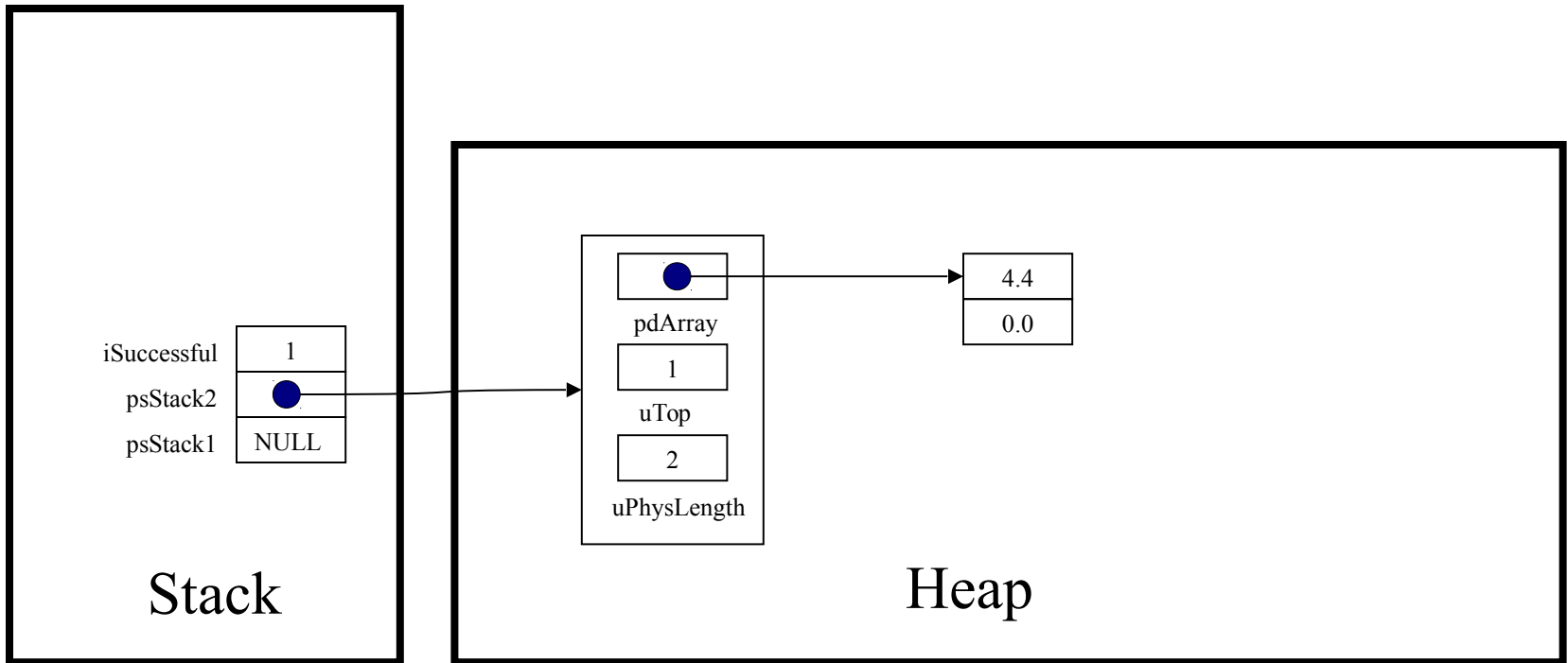

Princeton University
COS 217: Introduction to Programming Systems
Trace of teststack (Version 1)

```
if (! iSuccessful) handleMemoryError();
```

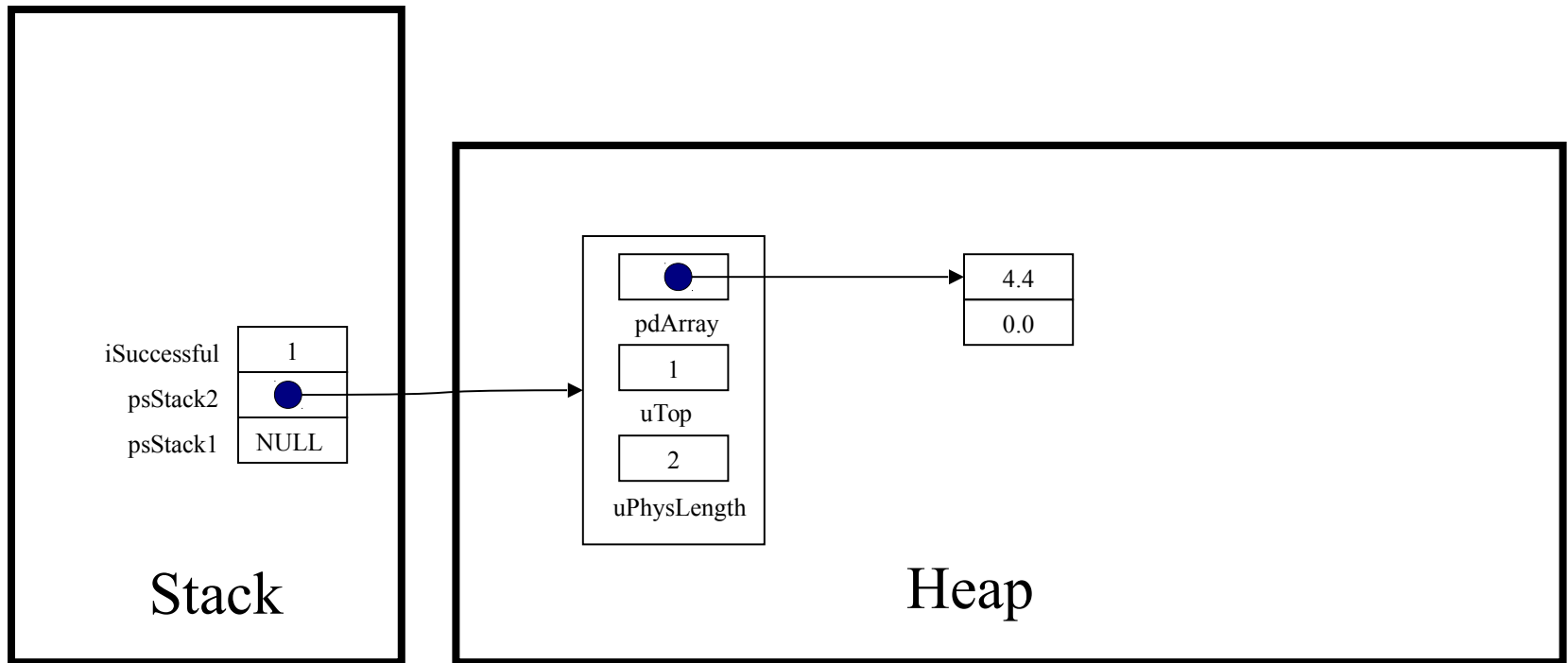

Princeton University
COS 217: Introduction to Programming Systems
Trace of teststack (Version 1)

```
iSuccessful = Stack_push(psStack2, 5.5);
```

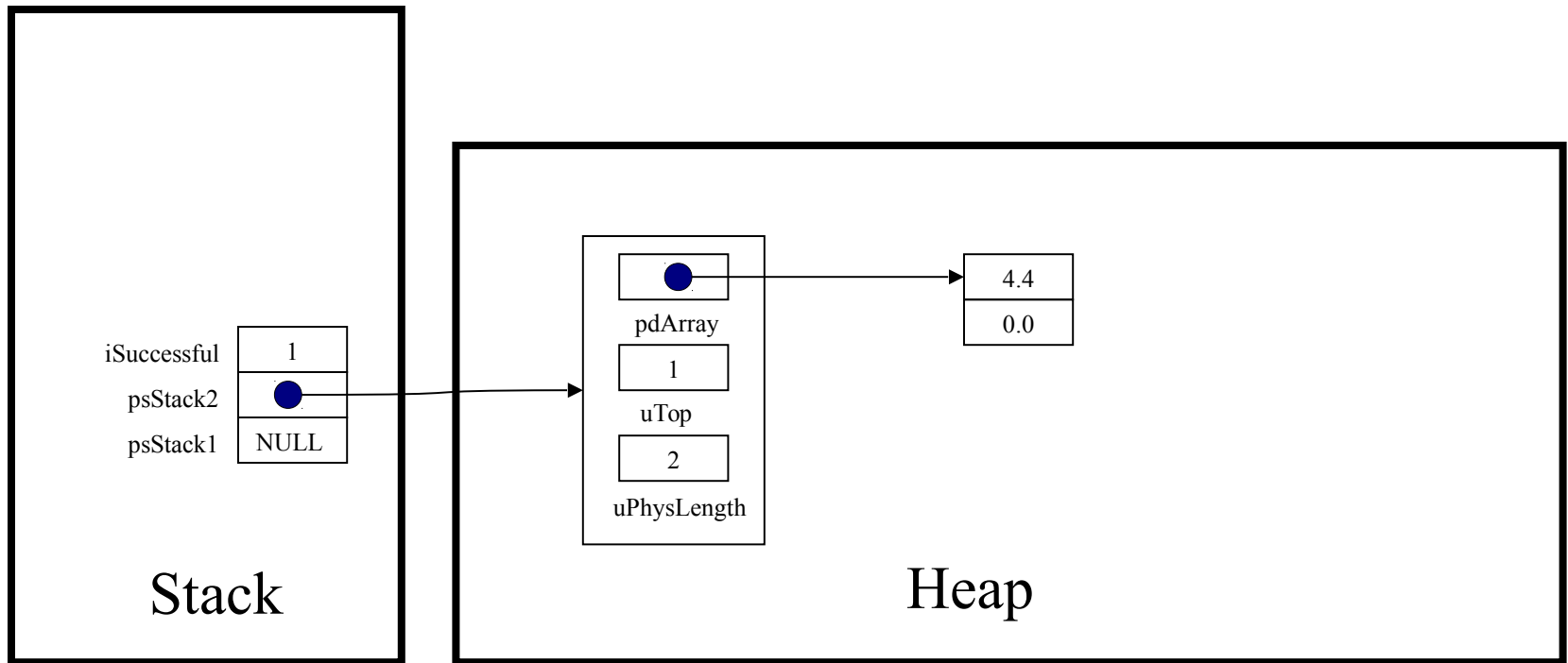

Princeton University
COS 217: Introduction to Programming Systems
Trace of teststack (Version 1)

```
int Stack_push(struct Stack *psStack, double dItem)
```

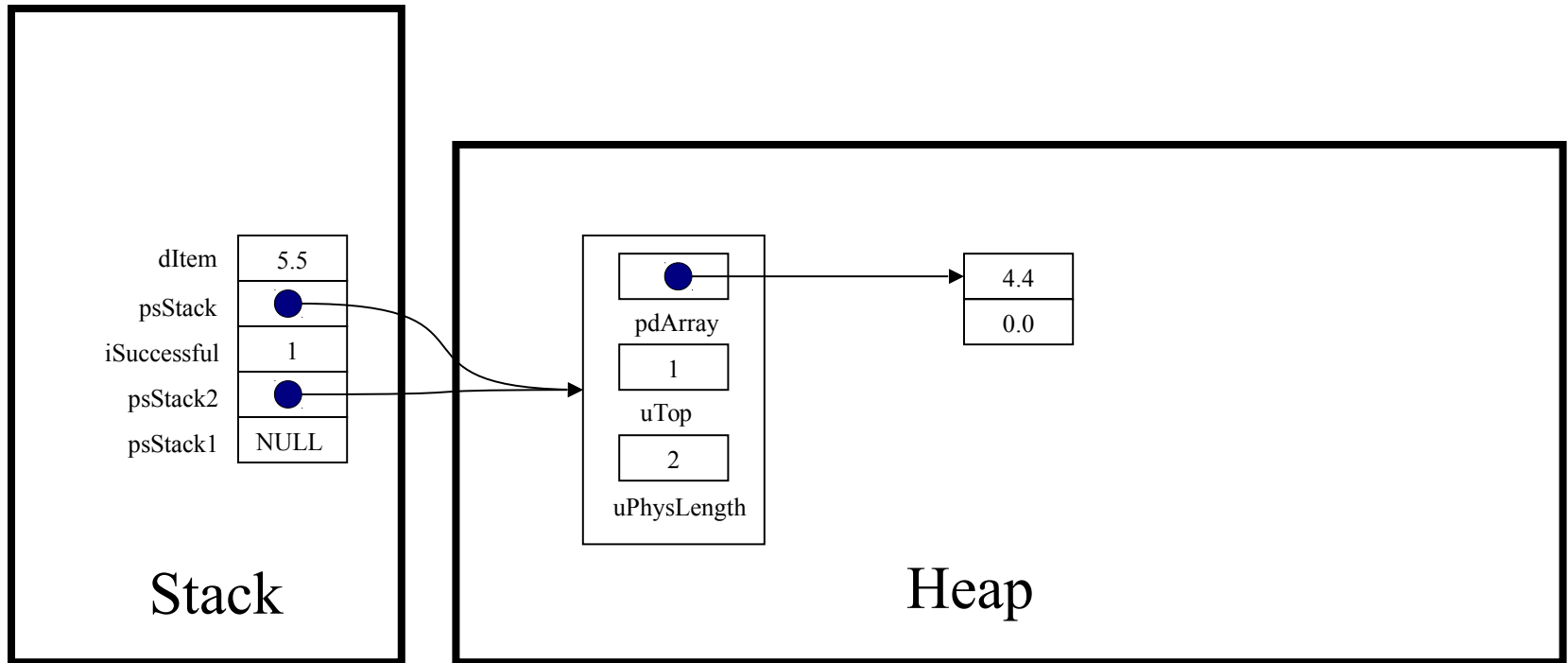

Princeton University
COS 217: Introduction to Programming Systems
Trace of teststack (Version 1)

```
int iSuccessful;
```

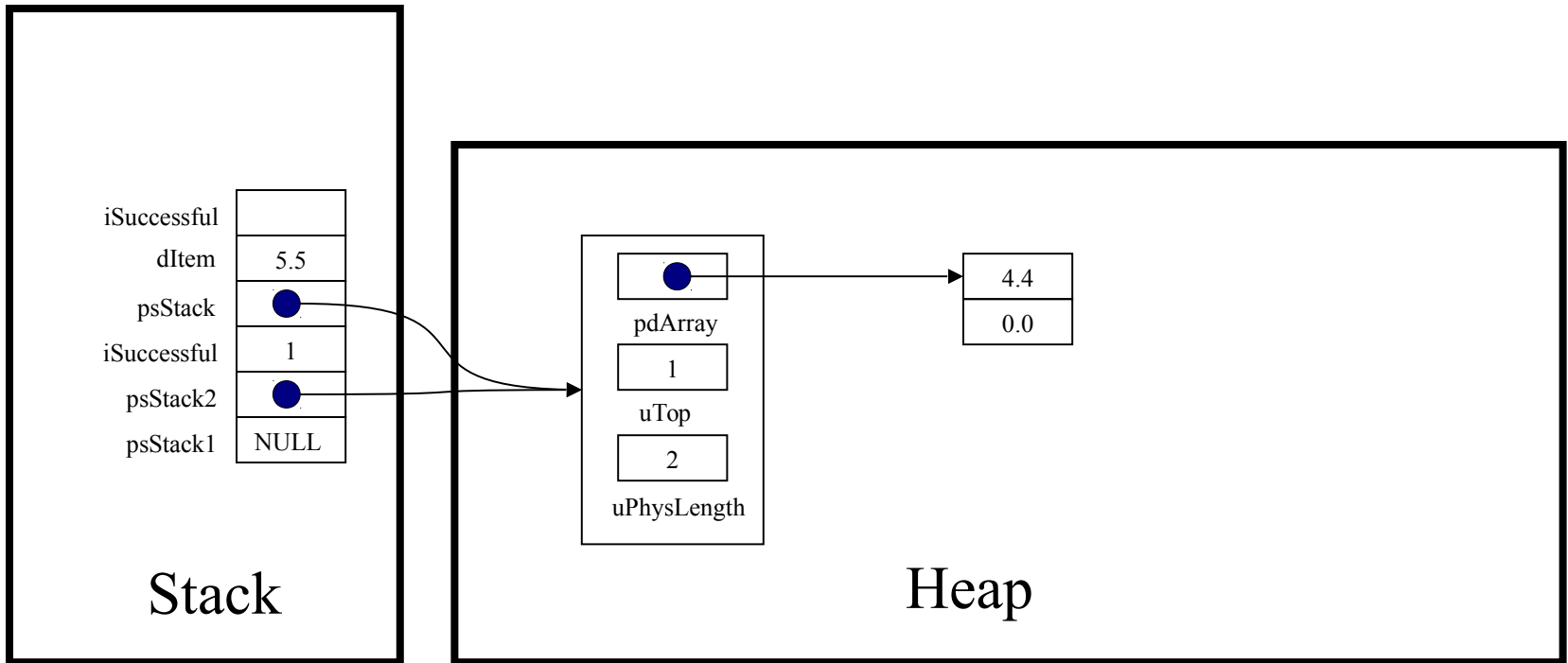

Princeton University
COS 217: Introduction to Programming Systems
Trace of teststack (Version 1)

```
assert (psStack != NULL);
```

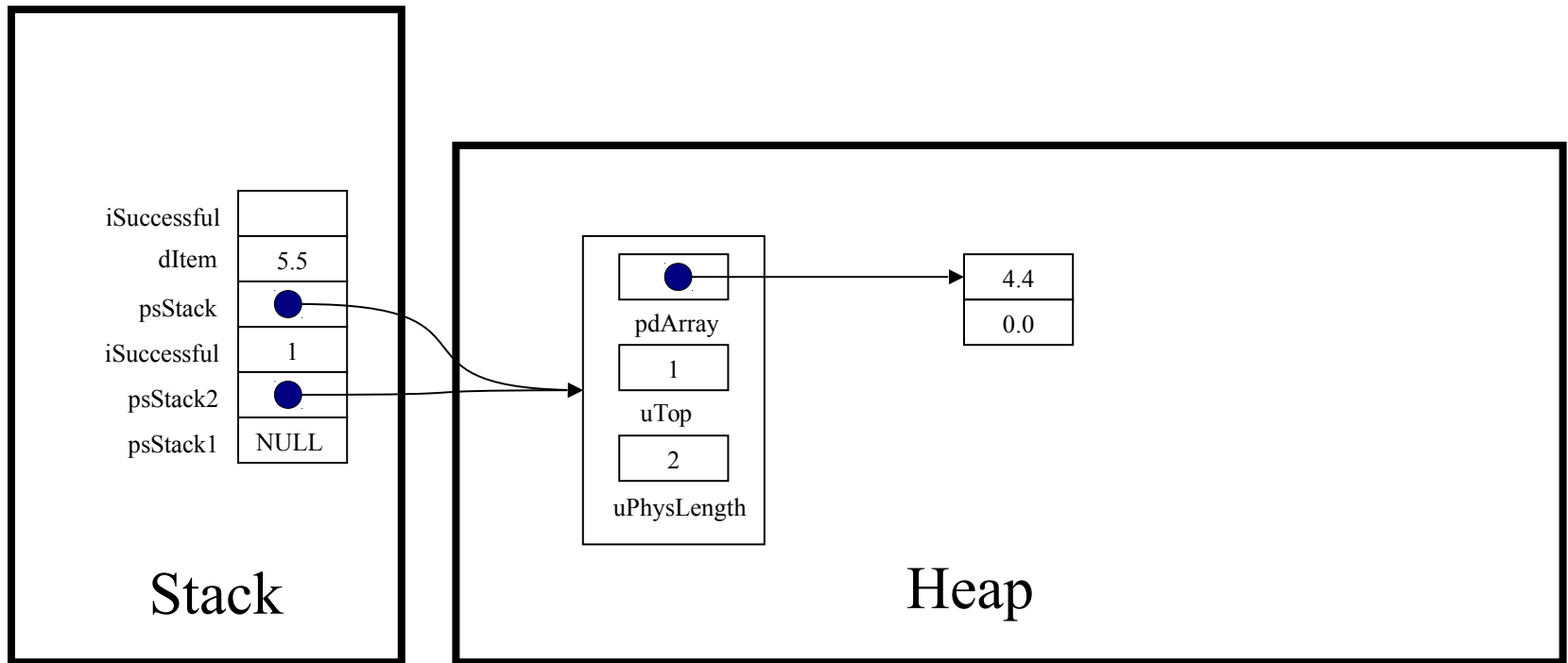

Princeton University
COS 217: Introduction to Programming Systems
Trace of teststack (Version 1)

```
if (psStack->uTop == psStack->uPhysLength)  
...
```

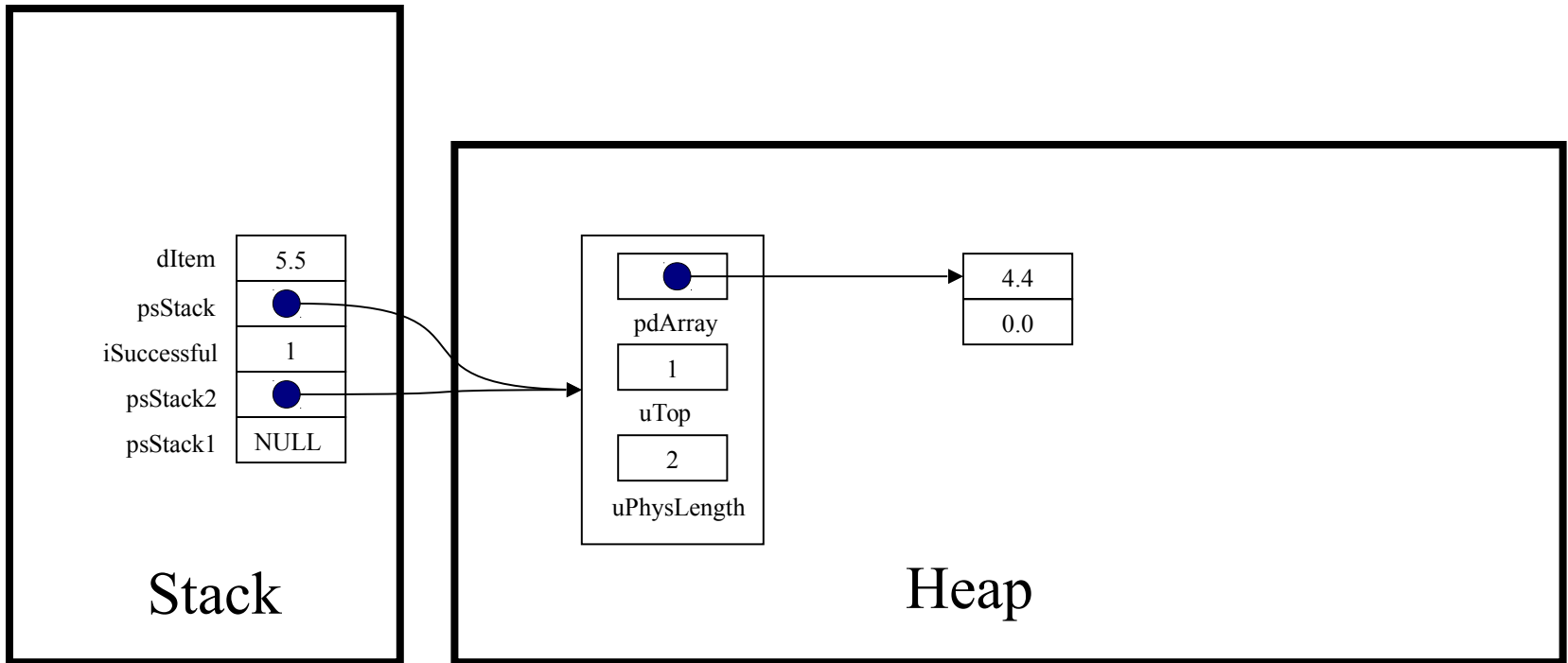

Princeton University
COS 217: Introduction to Programming Systems
Trace of teststack (Version 1)

```
(psStack->pdArray)[psStack->uTop] = dItem;
```

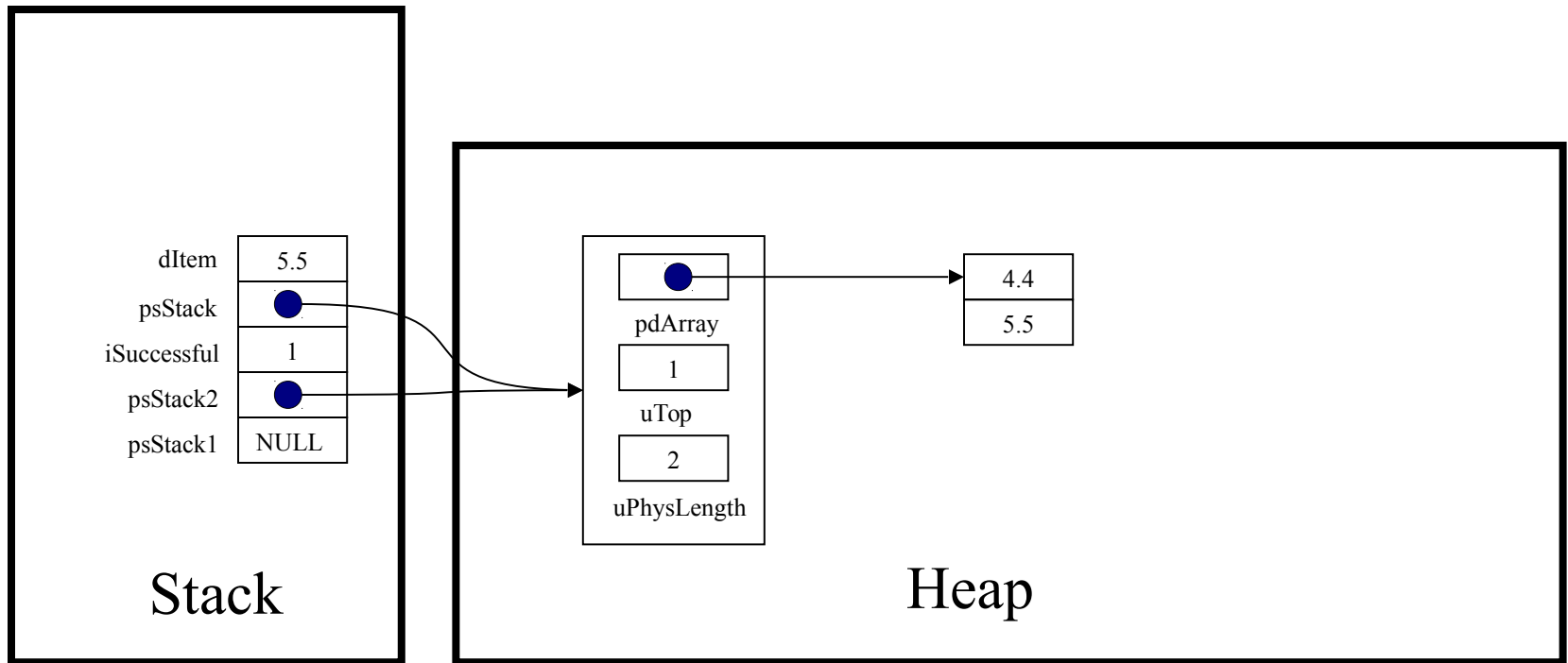

Princeton University
COS 217: Introduction to Programming Systems
Trace of teststack (Version 1)

```
(psStack->uTop) ++;
```

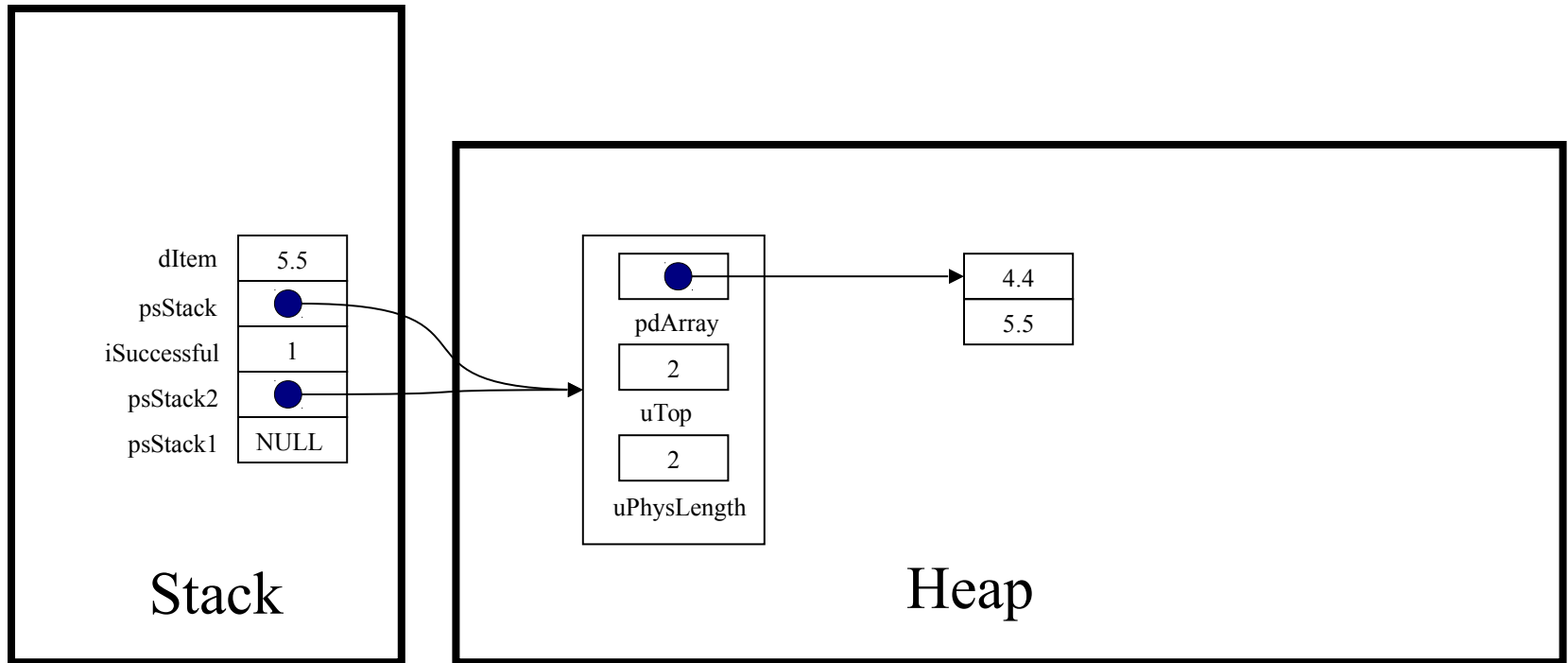

Princeton University
COS 217: Introduction to Programming Systems
Trace of teststack (Version 1)

```
return 1;
```

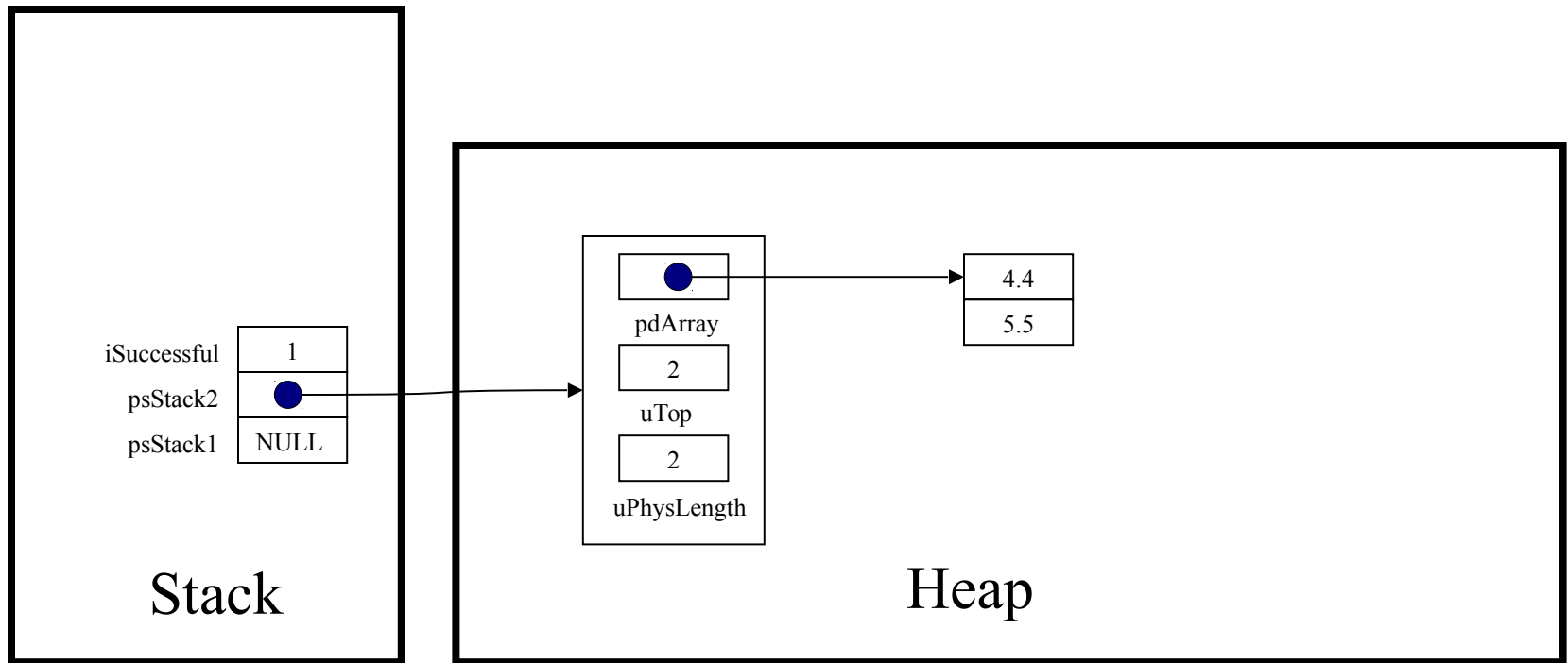

Princeton University
COS 217: Introduction to Programming Systems
Trace of teststack (Version 1)

```
iSuccessful = Stack_push(psStack2, 5.5);
```

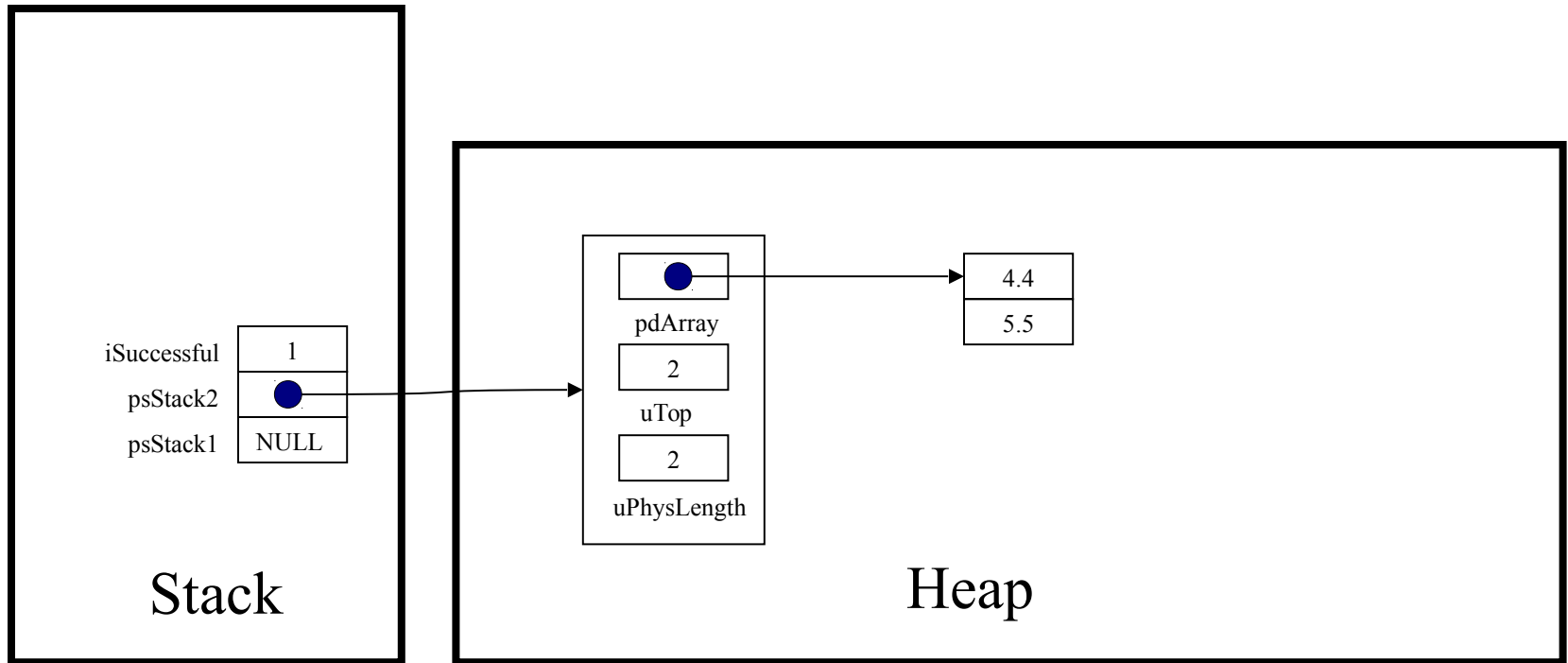

Princeton University
COS 217: Introduction to Programming Systems
Trace of teststack (Version 1)

```
if (! iSuccessful) handleMemoryError();
```

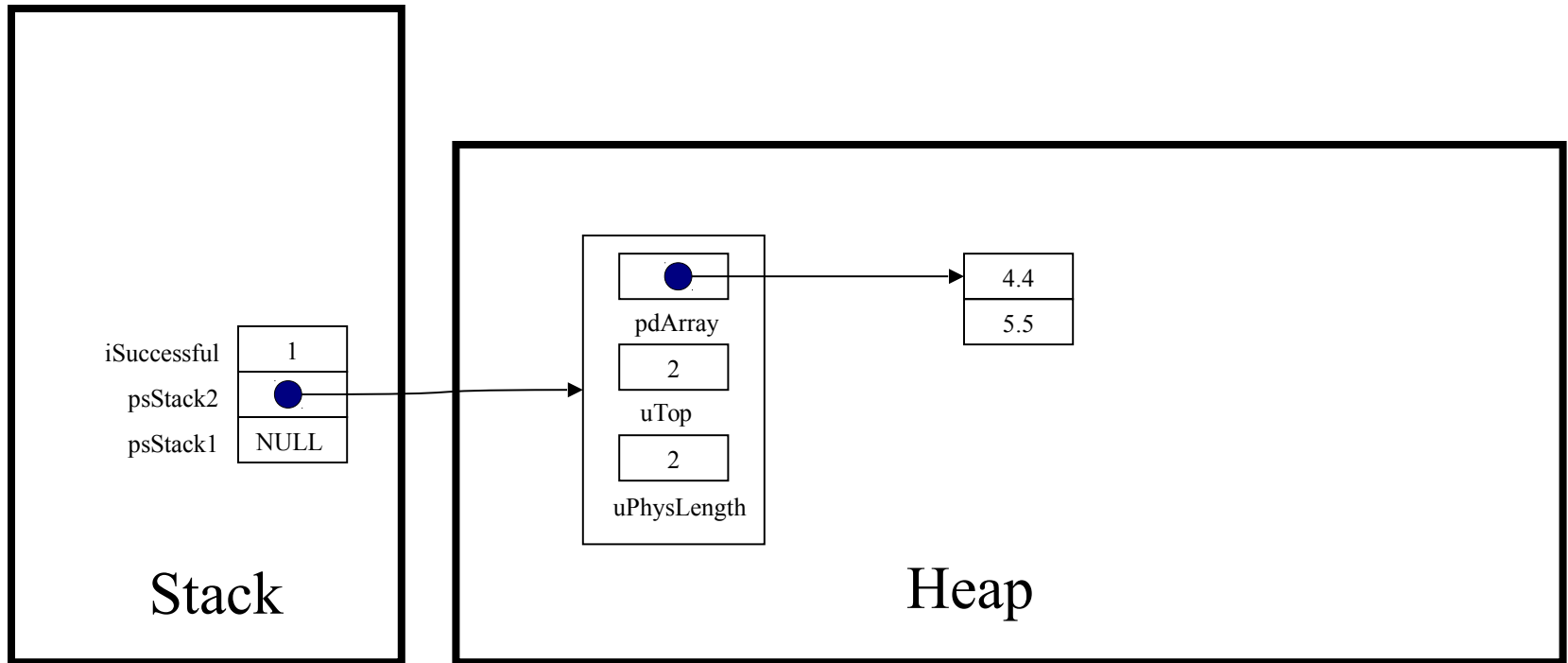

Princeton University
COS 217: Introduction to Programming Systems
Trace of teststack (Version 1)

```
iSuccessful = Stack_push(psStack2, 6.6);
```

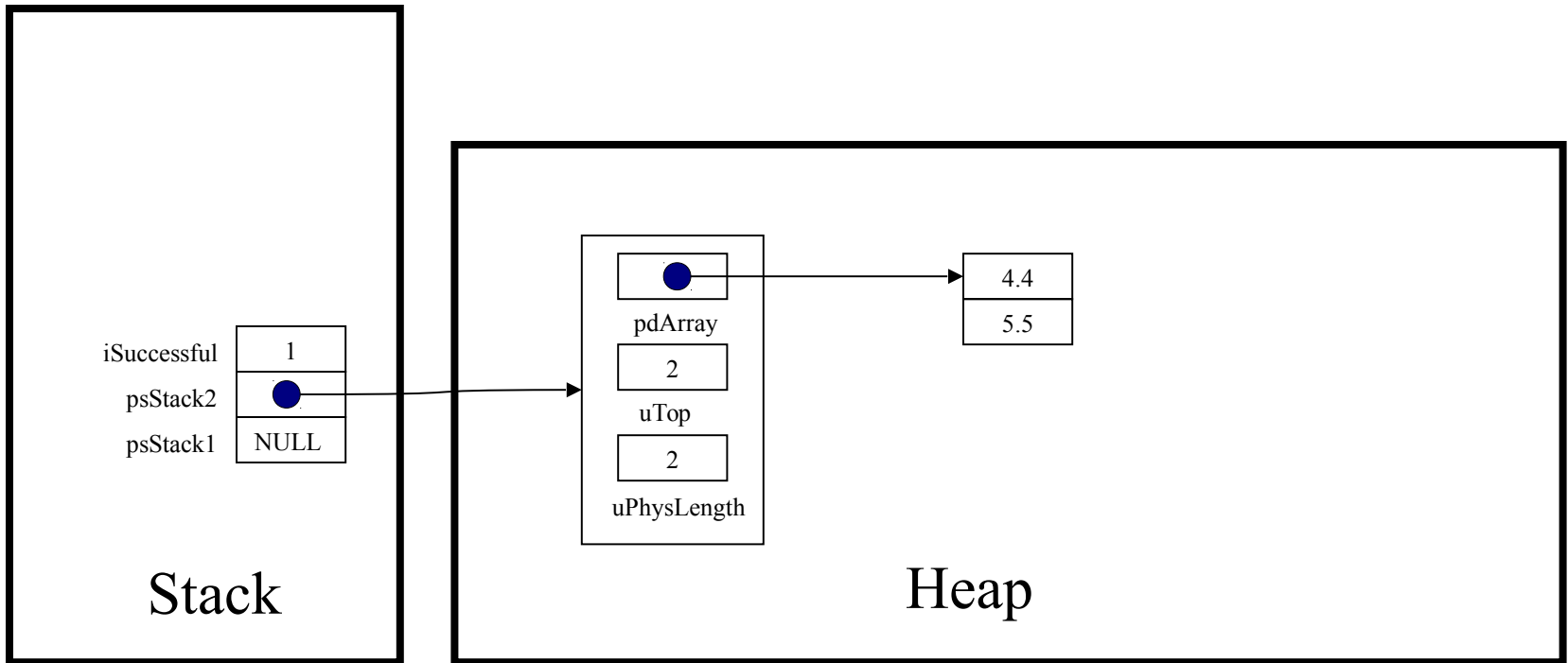

Princeton University
COS 217: Introduction to Programming Systems
Trace of teststack (Version 1)

```
int Stack_push(struct Stack *psStack, double dItem)
```

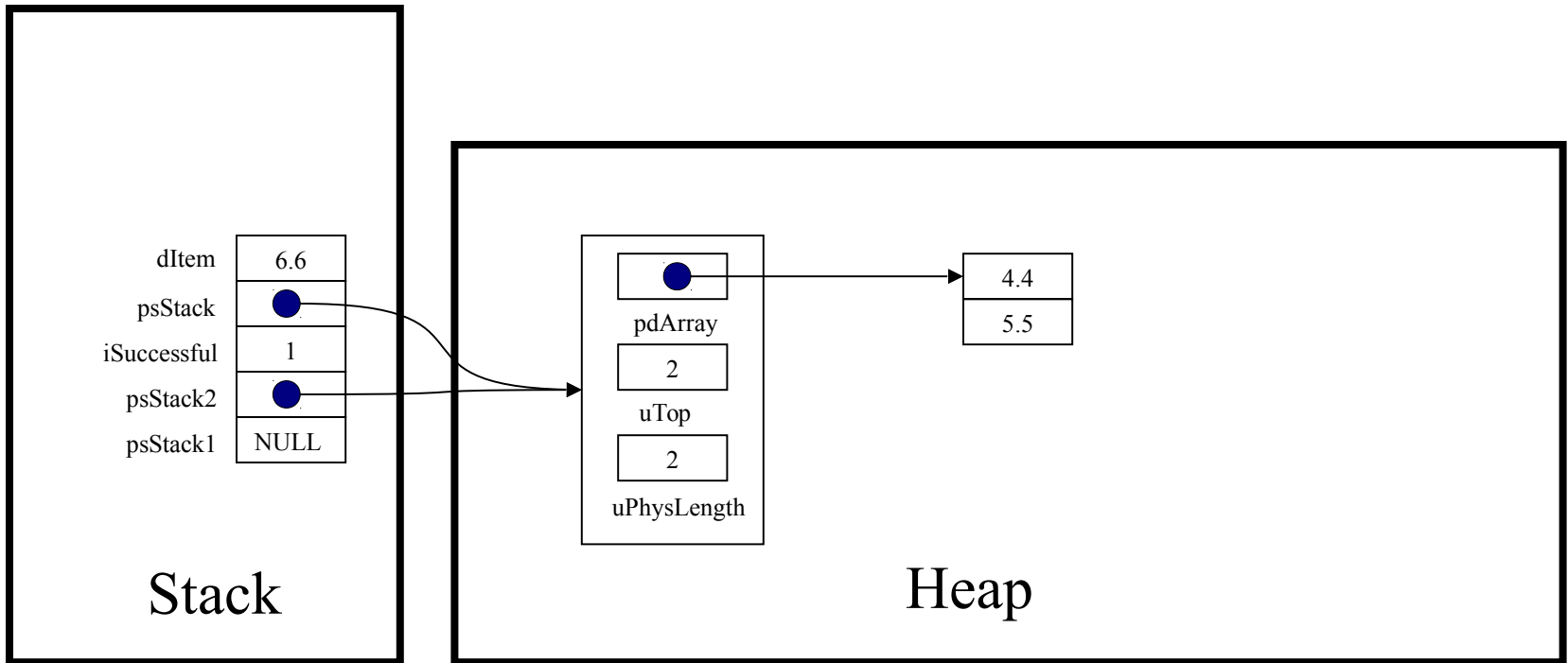

Princeton University
COS 217: Introduction to Programming Systems
Trace of teststack (Version 1)

```
int iSuccessful;
```

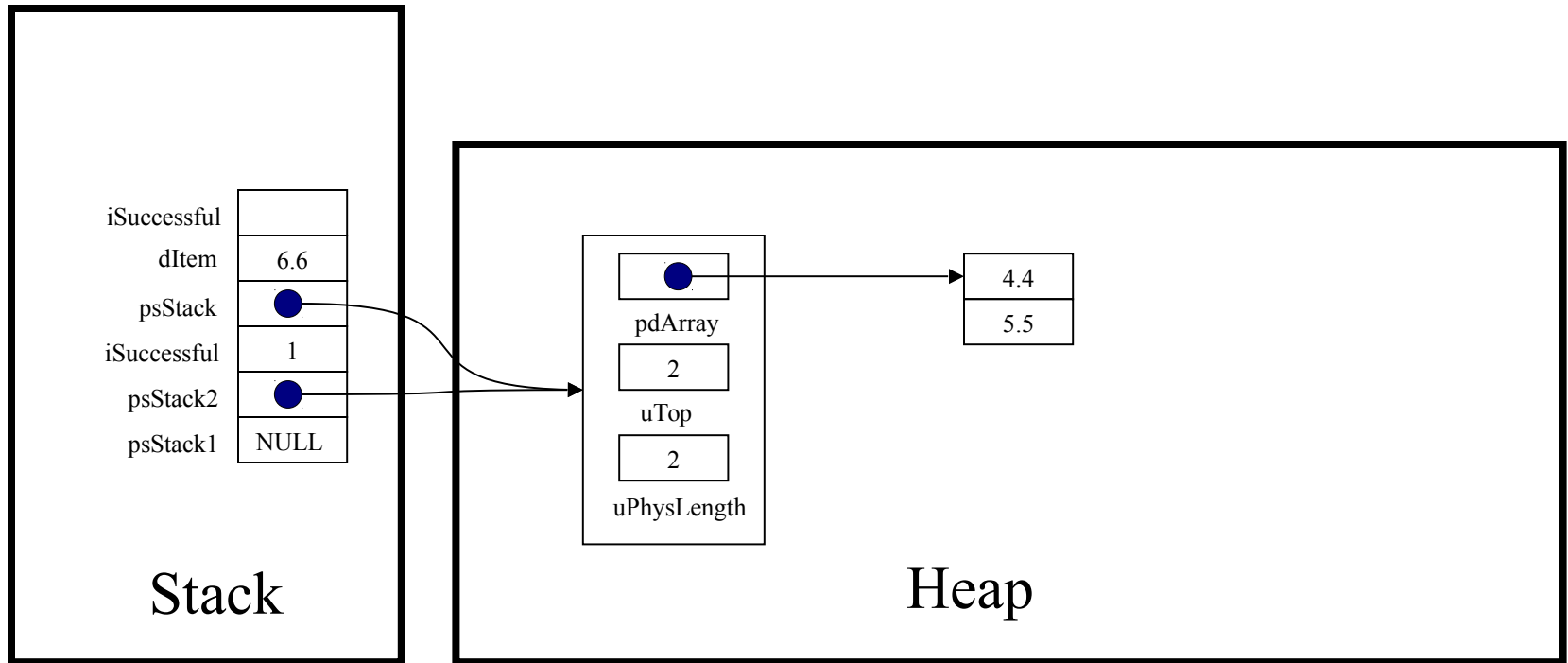

Princeton University
COS 217: Introduction to Programming Systems
Trace of teststack (Version 1)

```
assert (psStack != NULL);
```

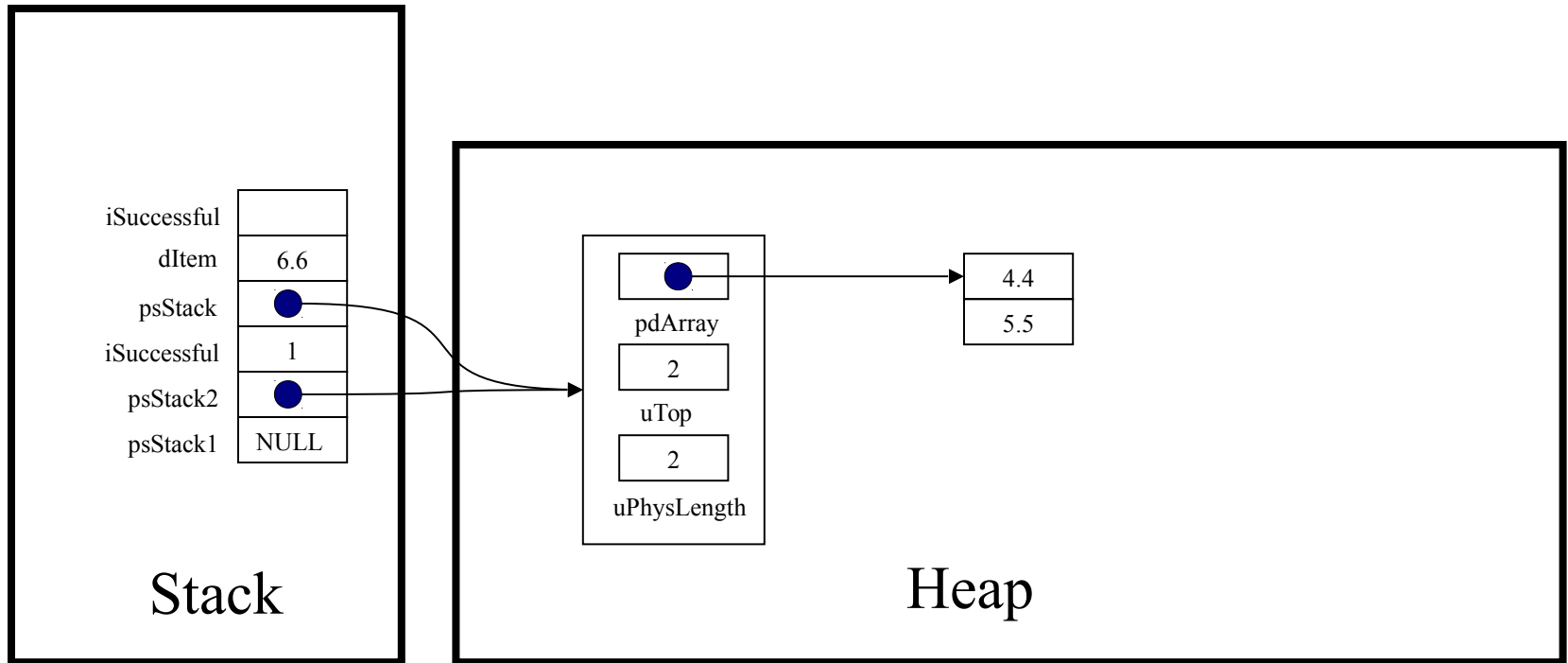

Princeton University
COS 217: Introduction to Programming Systems
Trace of teststack (Version 1)

```
if (psStack->uTop == psStack->uPhysLength)
```

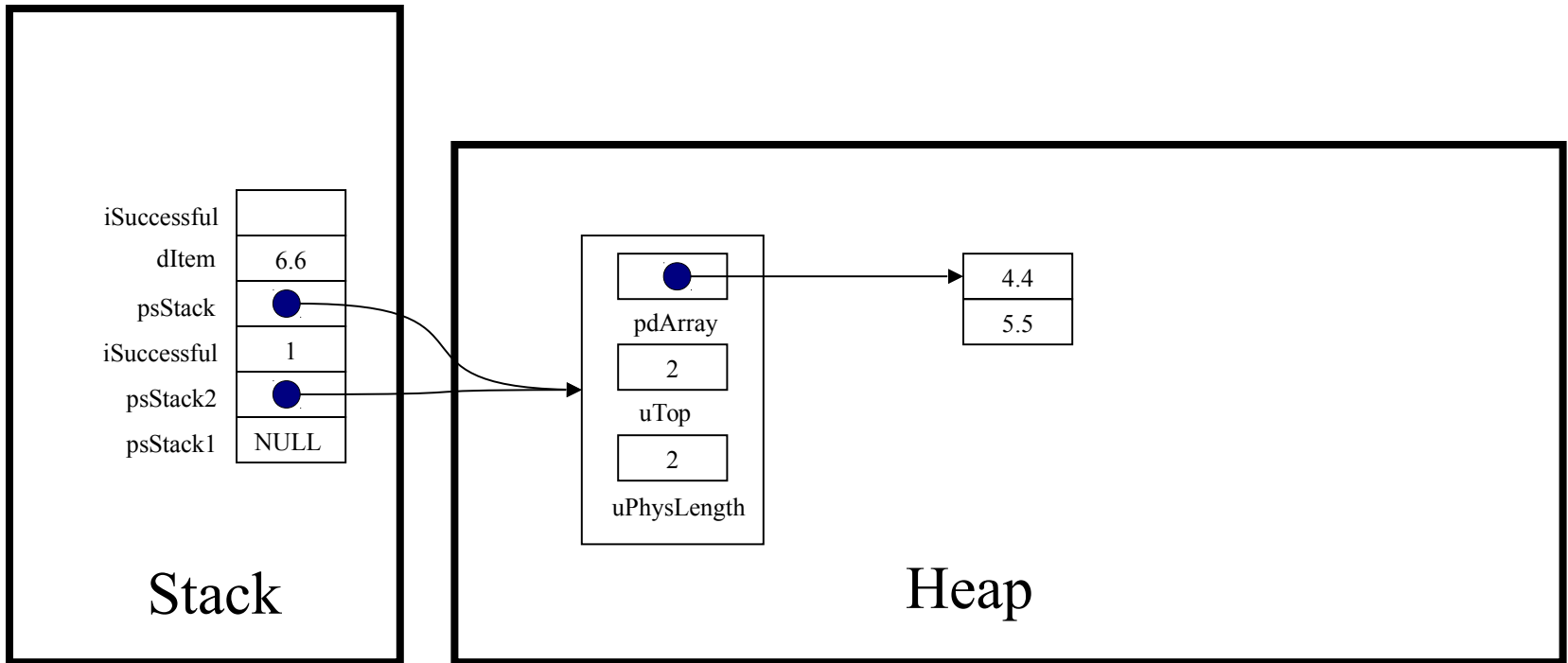

Princeton University
COS 217: Introduction to Programming Systems
Trace of teststack (Version 1)

```
iSuccessful = Stack_grow(psStack);
```

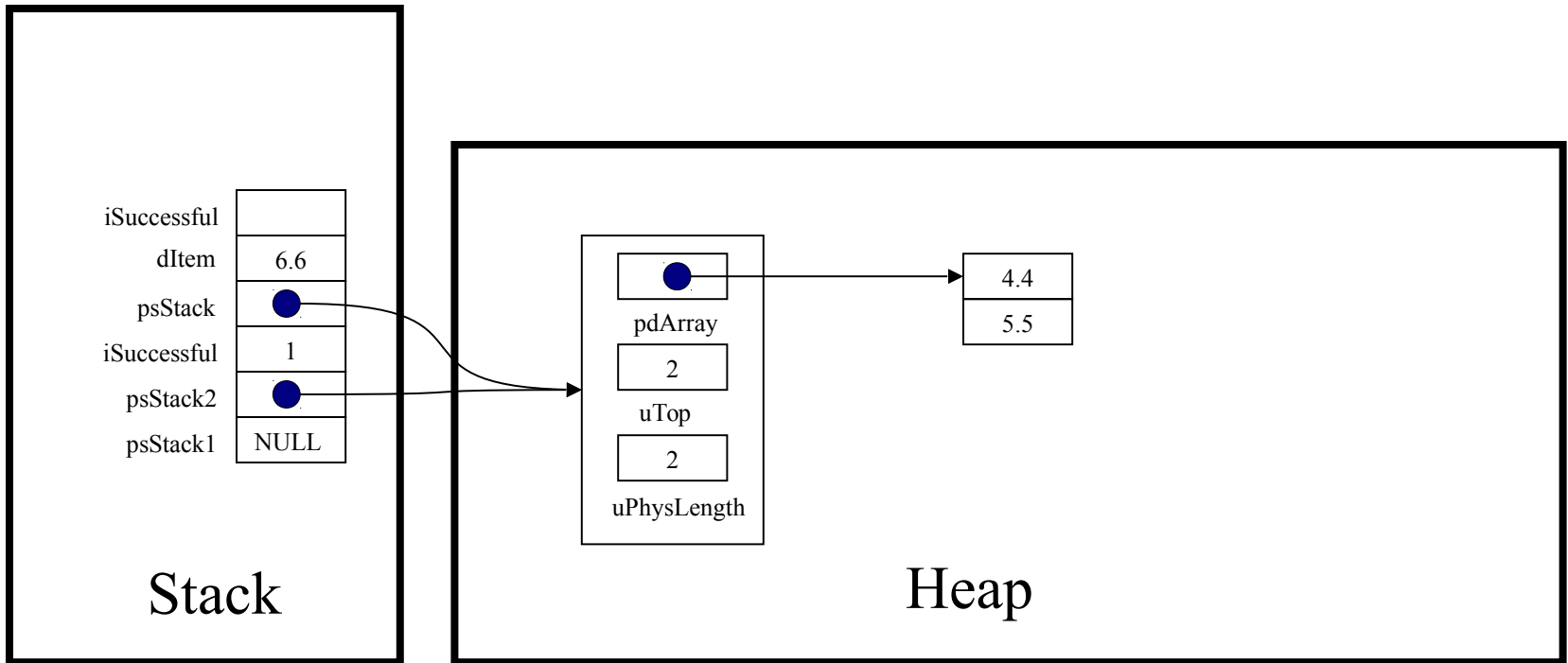

Princeton University
COS 217: Introduction to Programming Systems
Trace of teststack (Version 1)

```
static int Stack_grow(struct Stack *psStack)
```

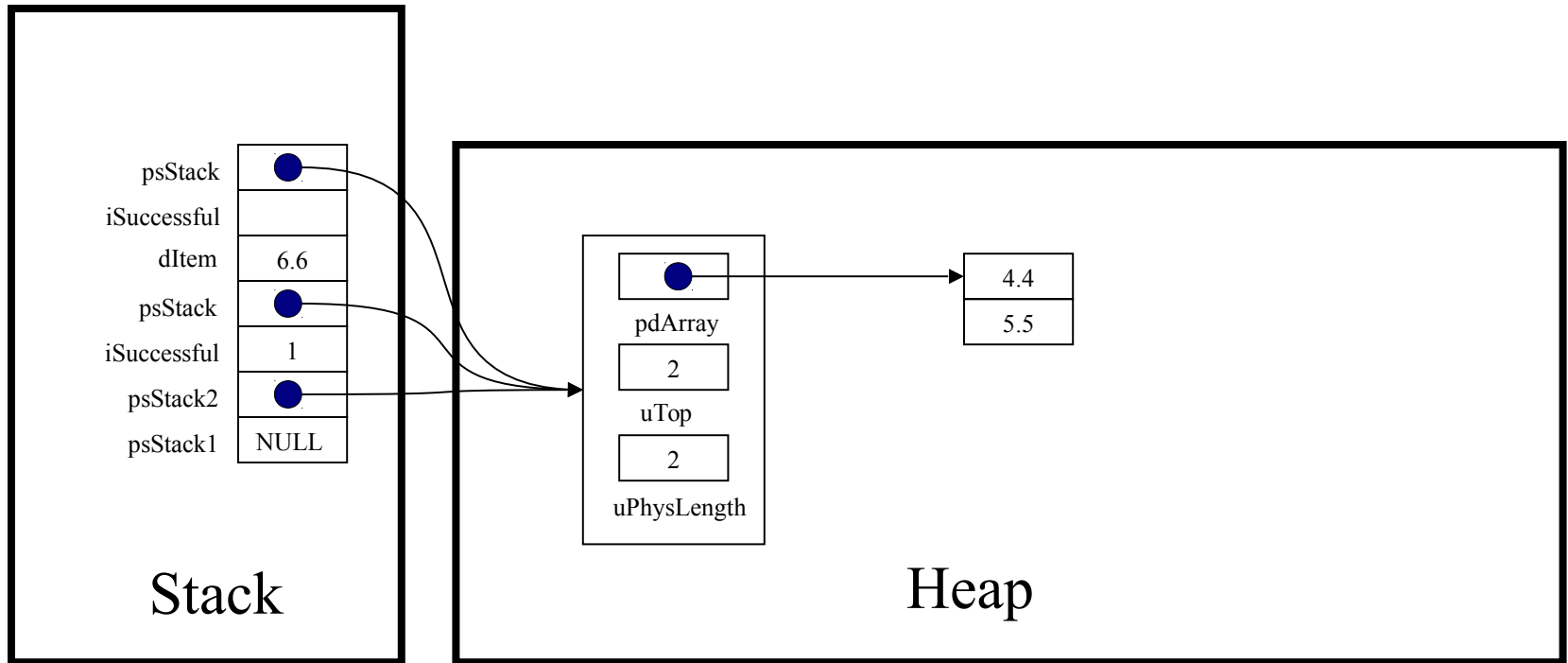

Princeton University
COS 217: Introduction to Programming Systems
Trace of teststack (Version 1)

```
size_t uNewPhysLength;
```

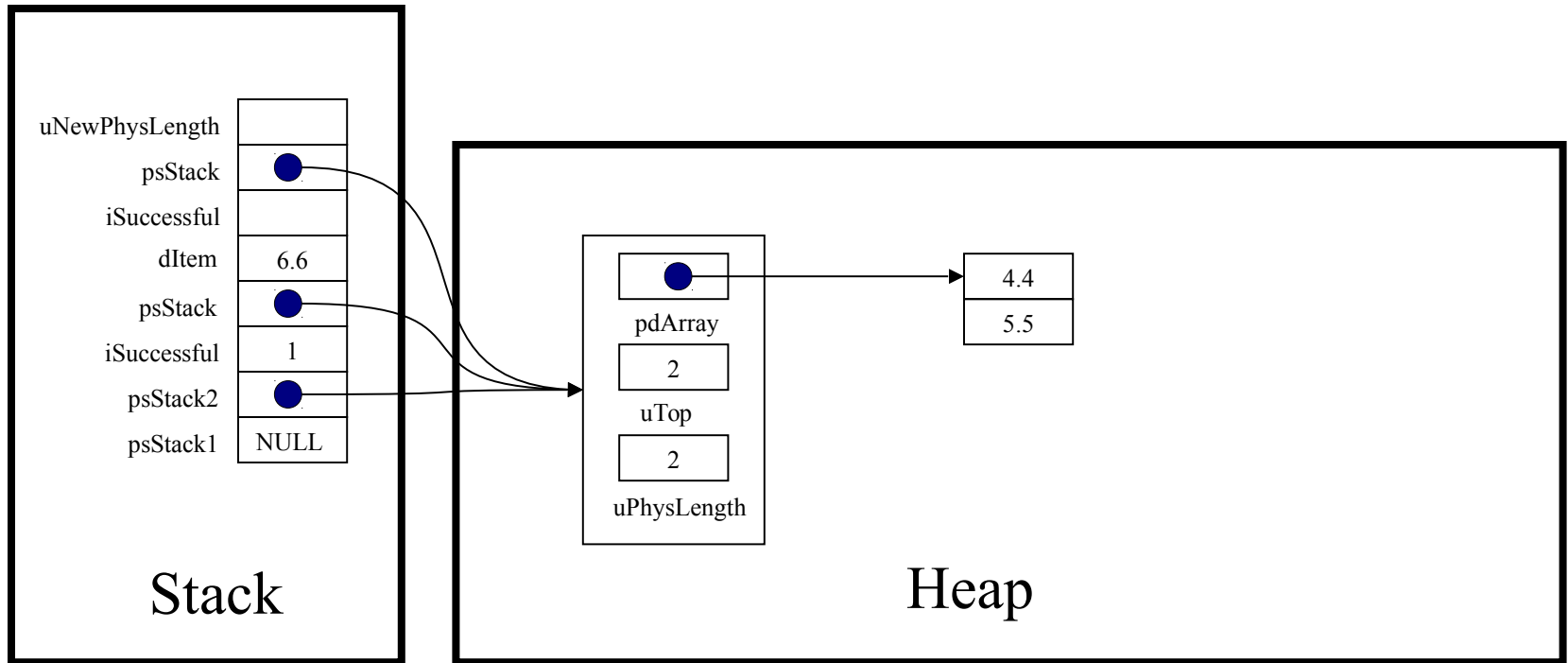

Princeton University
COS 217: Introduction to Programming Systems
Trace of teststack (Version 1)

```
double *pdNewArray;
```

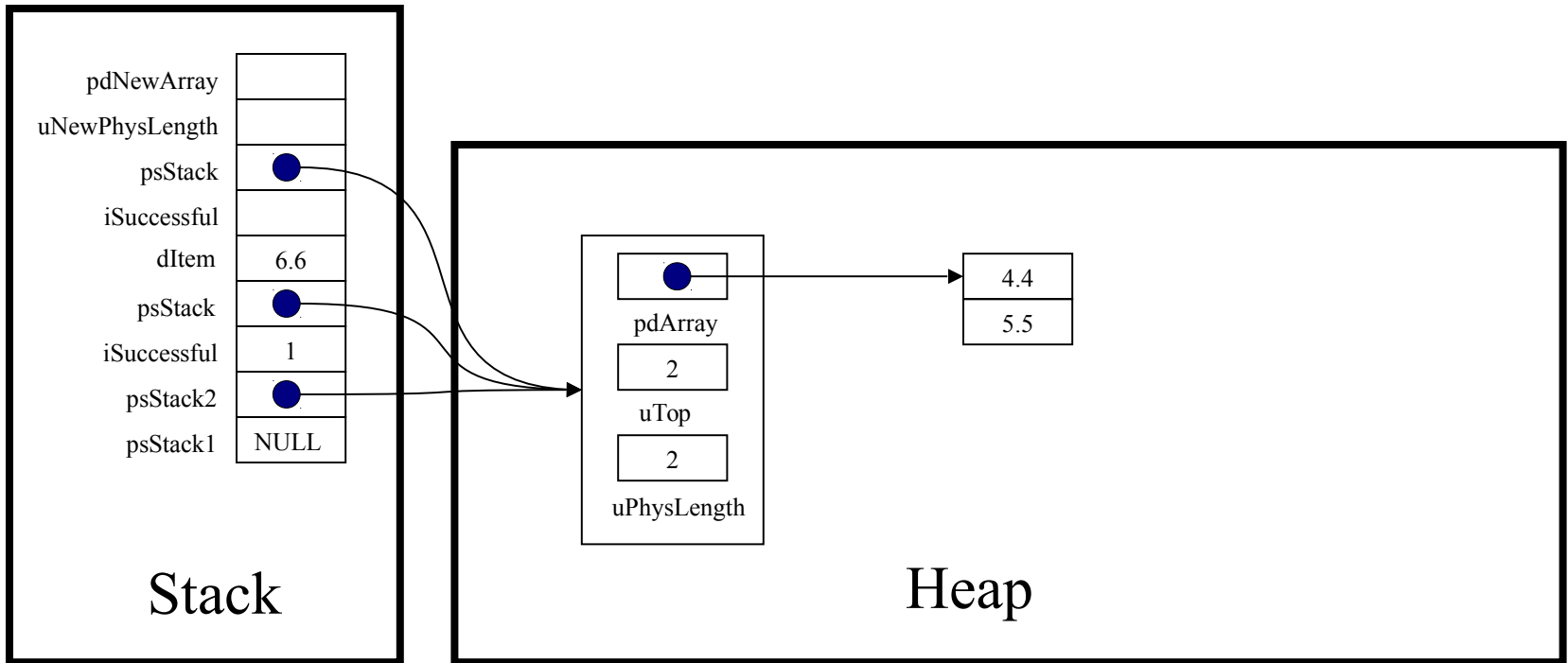

Princeton University
COS 217: Introduction to Programming Systems
Trace of teststack (Version 1)

```
assert (psStack != NULL);
```

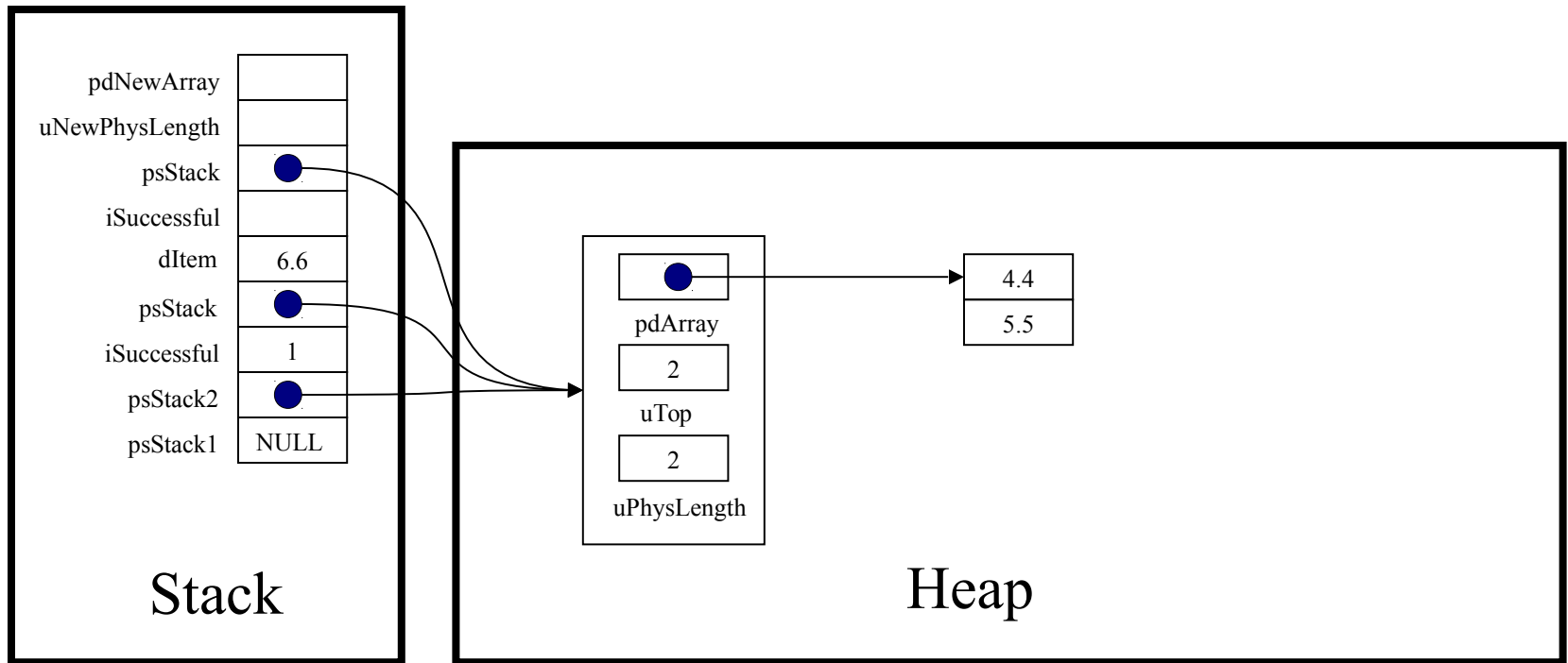

Princeton University
COS 217: Introduction to Programming Systems
Trace of teststack (Version 1)

```
uNewPhysLength = GROWTH_FACTOR * pcStack->uPhysLength;
```

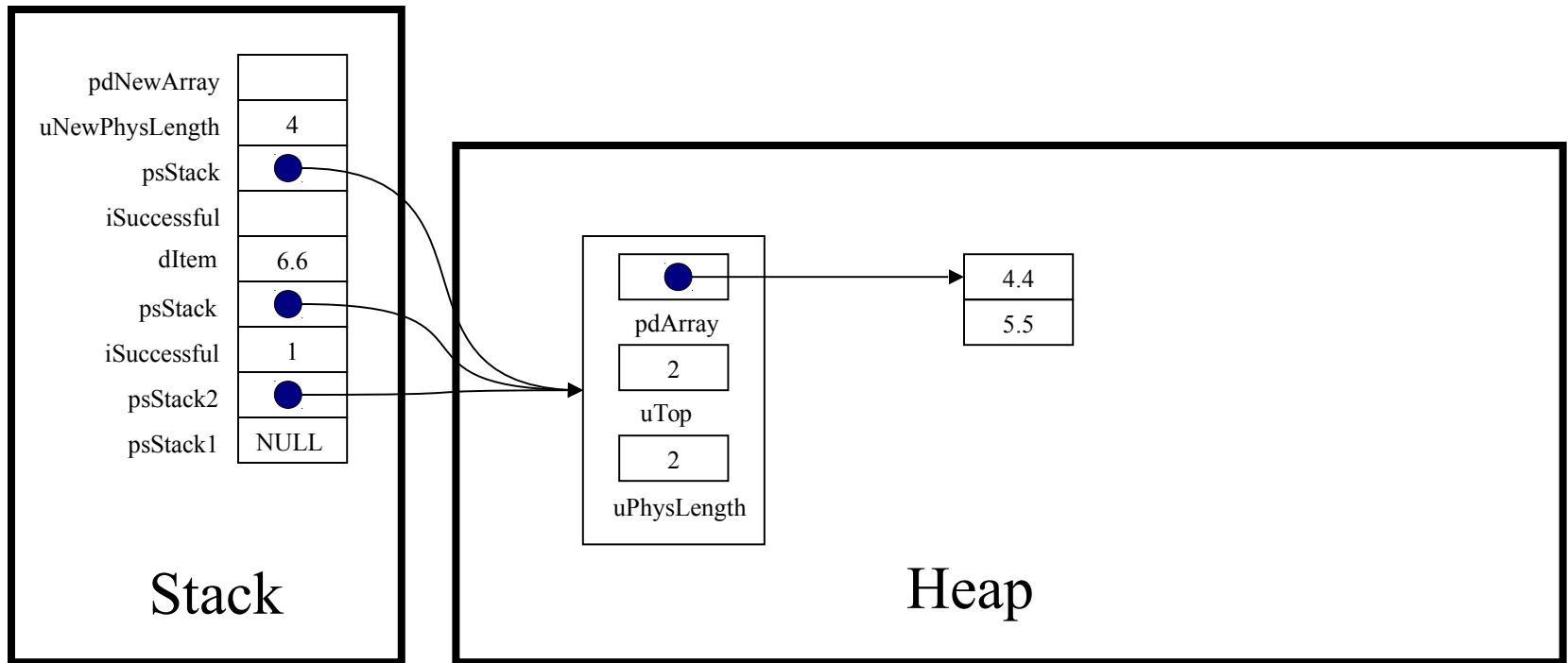

Princeton University
COS 217: Introduction to Programming Systems
Trace of teststack (Version 1)

```
pdNewArray = (double*)  
  realloc(psStack->pdArray, sizeof(double) * uNewPhysLength);
```

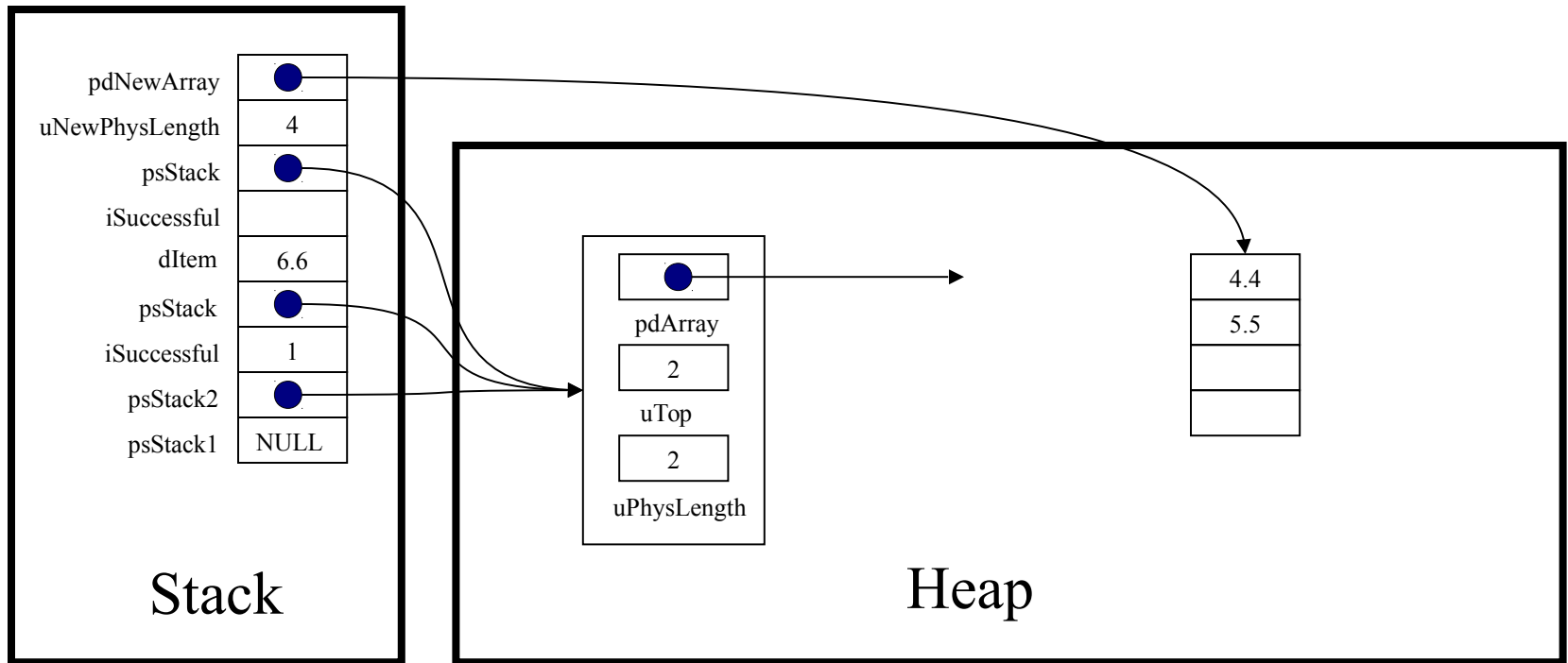

Princeton University
COS 217: Introduction to Programming Systems
Trace of teststack (Version 1)

```
if (pdNewArray == NULL)  
    return 0;
```

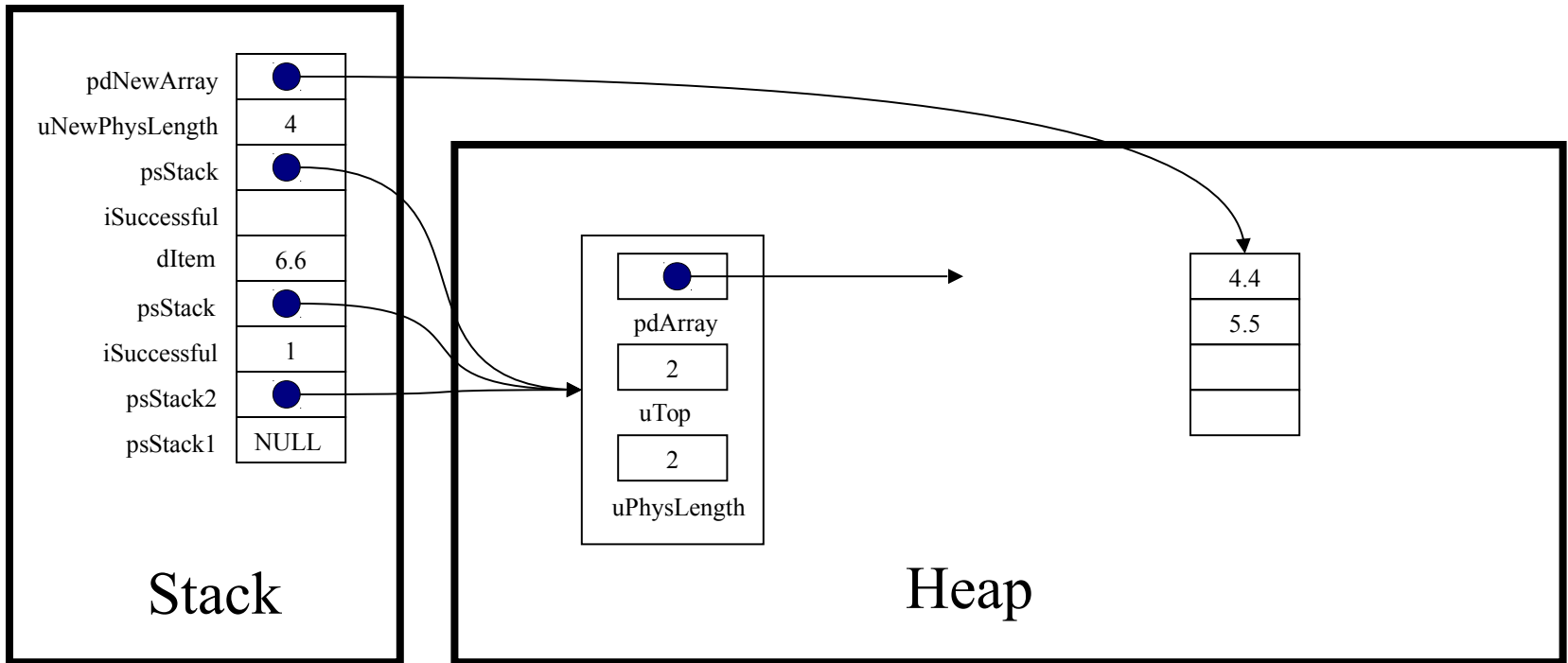

Princeton University
COS 217: Introduction to Programming Systems
Trace of teststack (Version 1)

```
psStack->uPhysLength = uNewPhysLength;
```

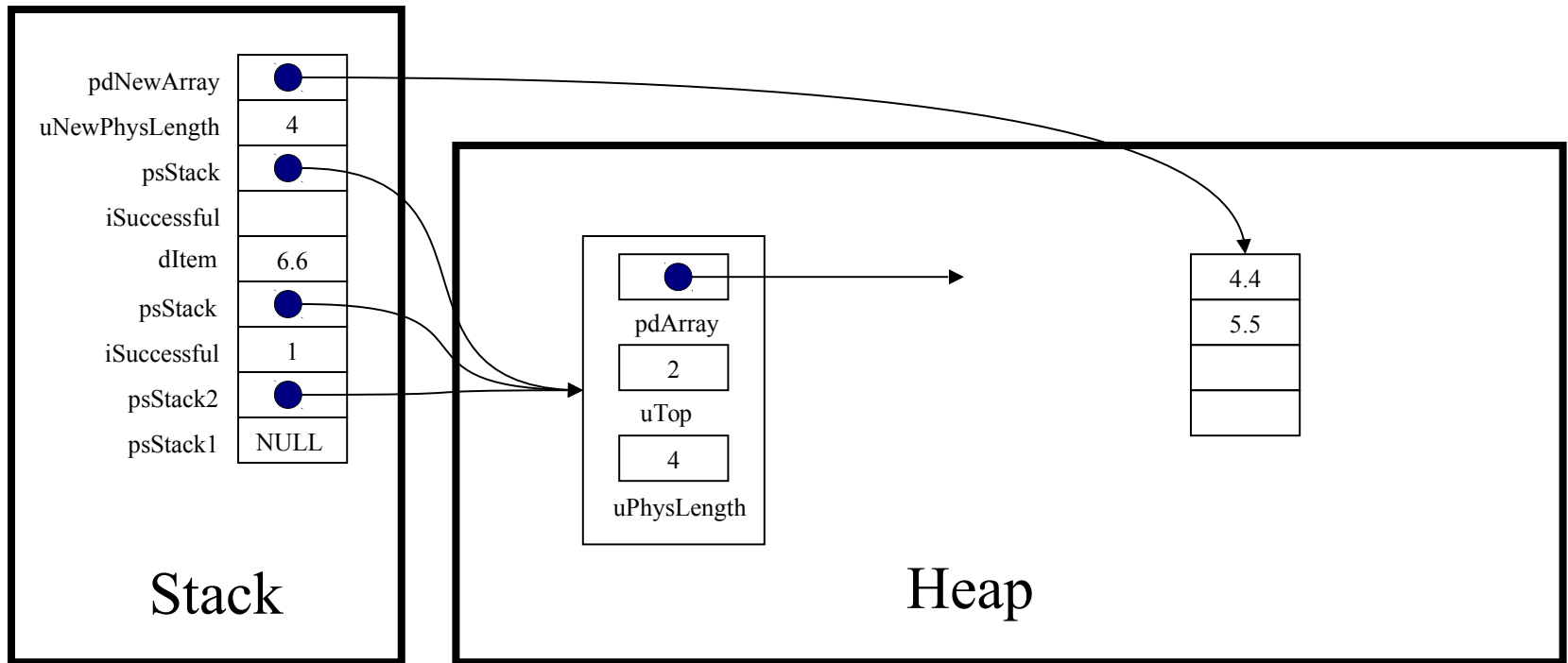

Princeton University
COS 217: Introduction to Programming Systems
Trace of teststack (Version 1)

```
psStack->pdArray = pdNewArray;
```

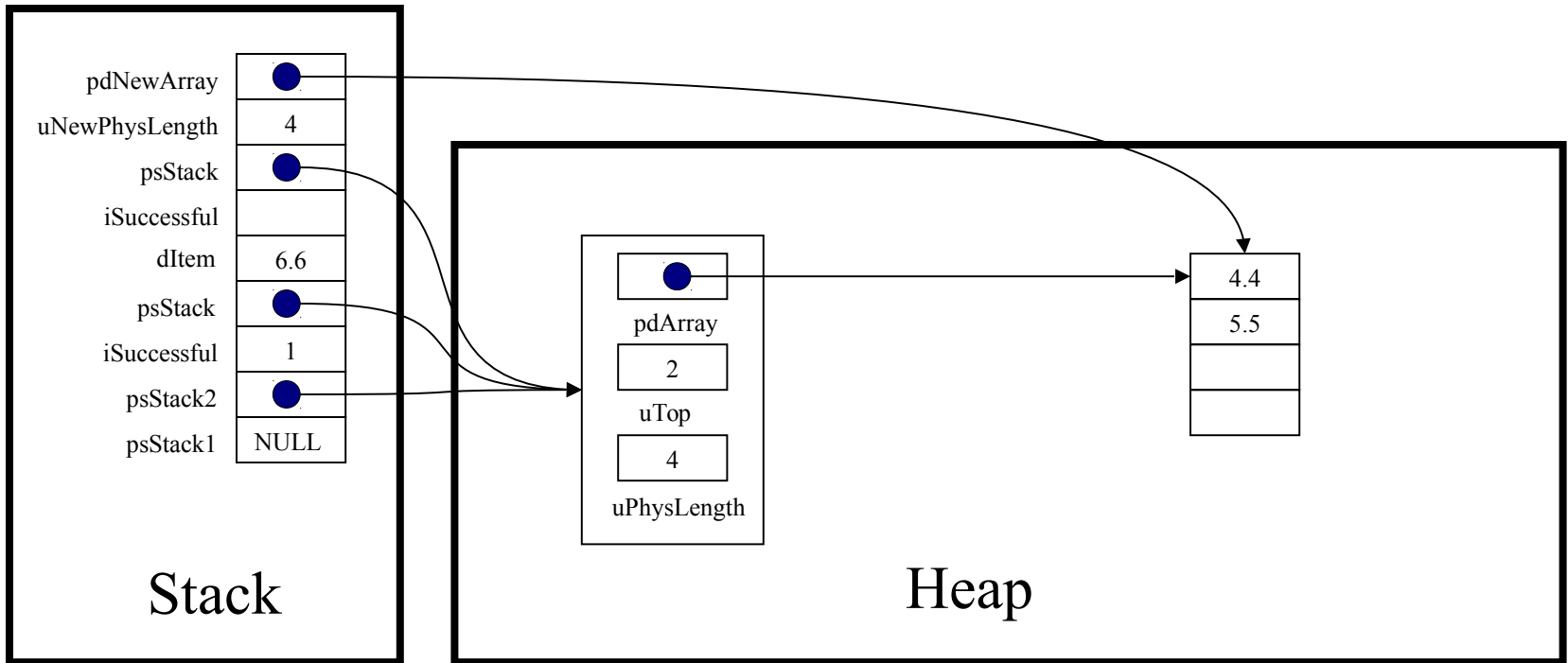

Princeton University
COS 217: Introduction to Programming Systems
Trace of teststack (Version 1)

```
return 1;
```

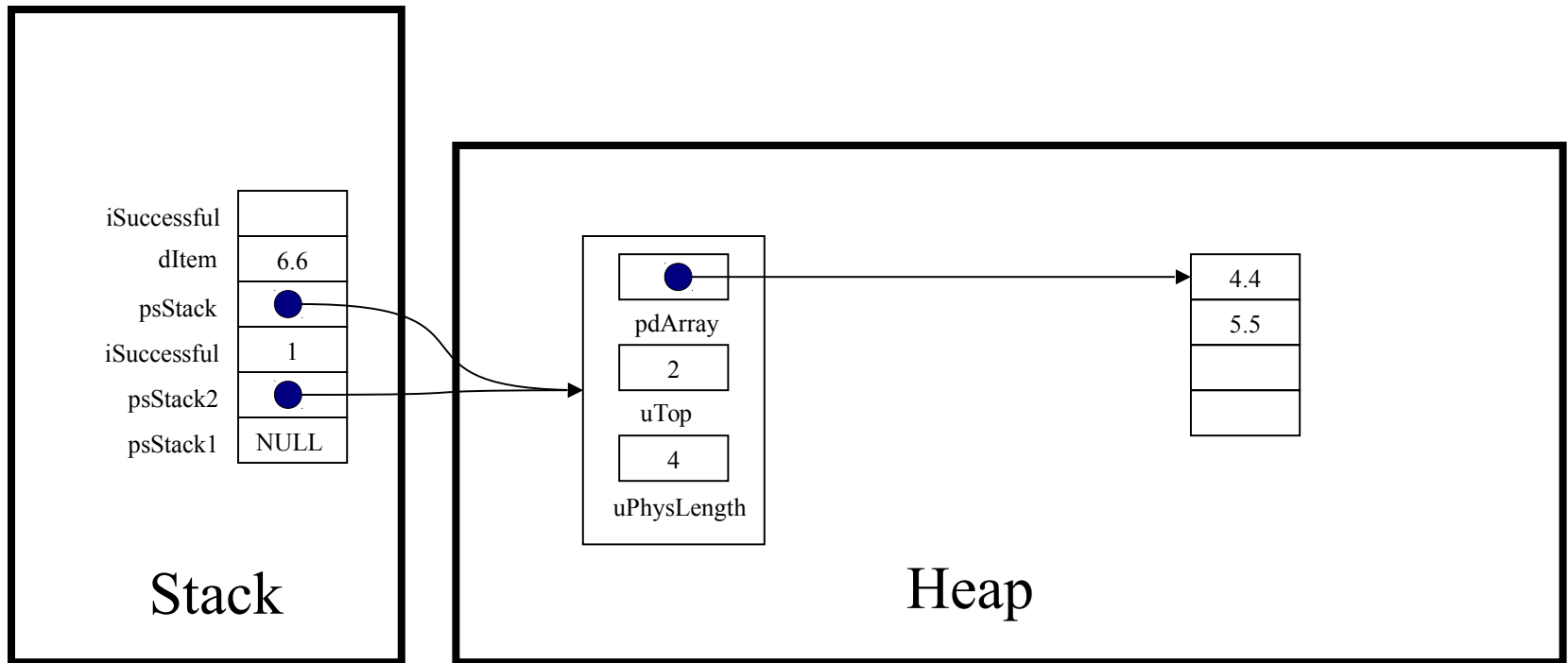

Princeton University
COS 217: Introduction to Programming Systems
Trace of teststack (Version 1)

```
iSuccessful = Stack_grow(psStack);
```

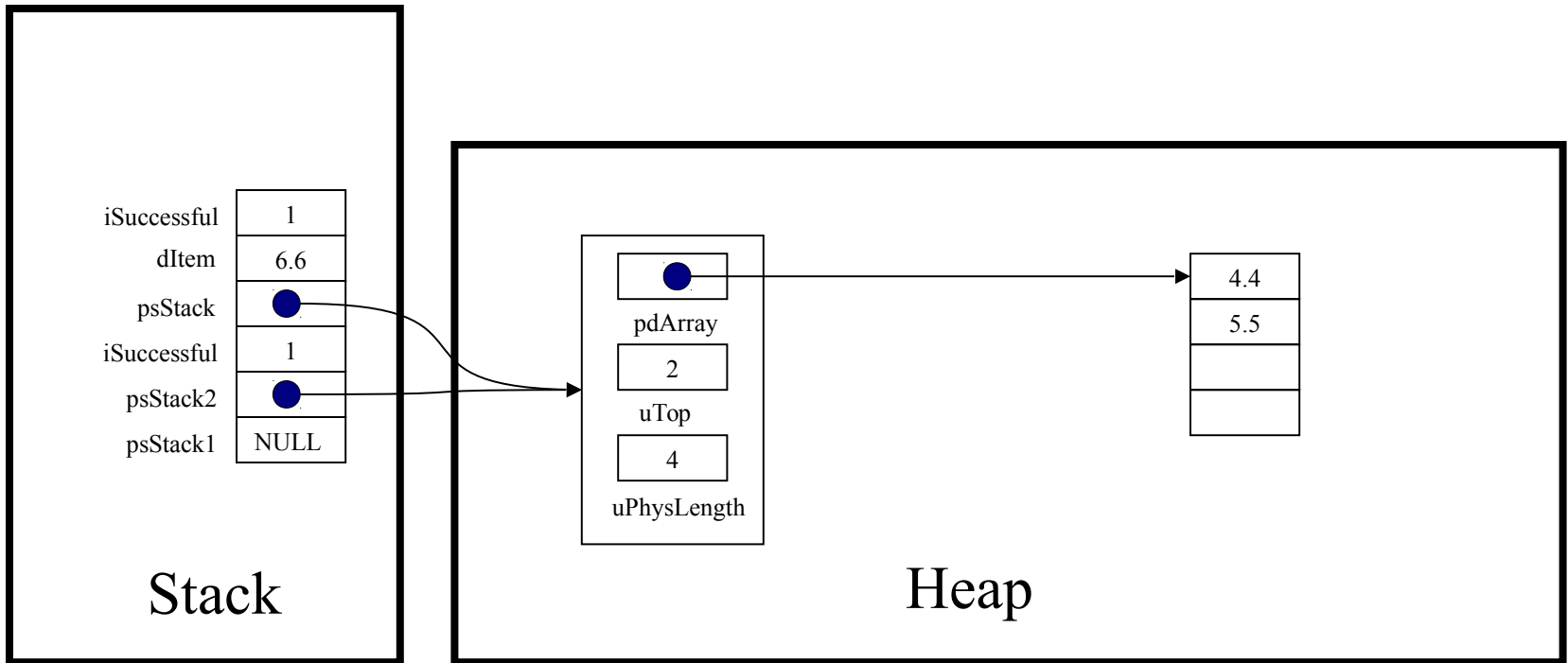

Princeton University
COS 217: Introduction to Programming Systems
Trace of teststack (Version 1)

```
if (! iSuccessful)  
    return 0;
```

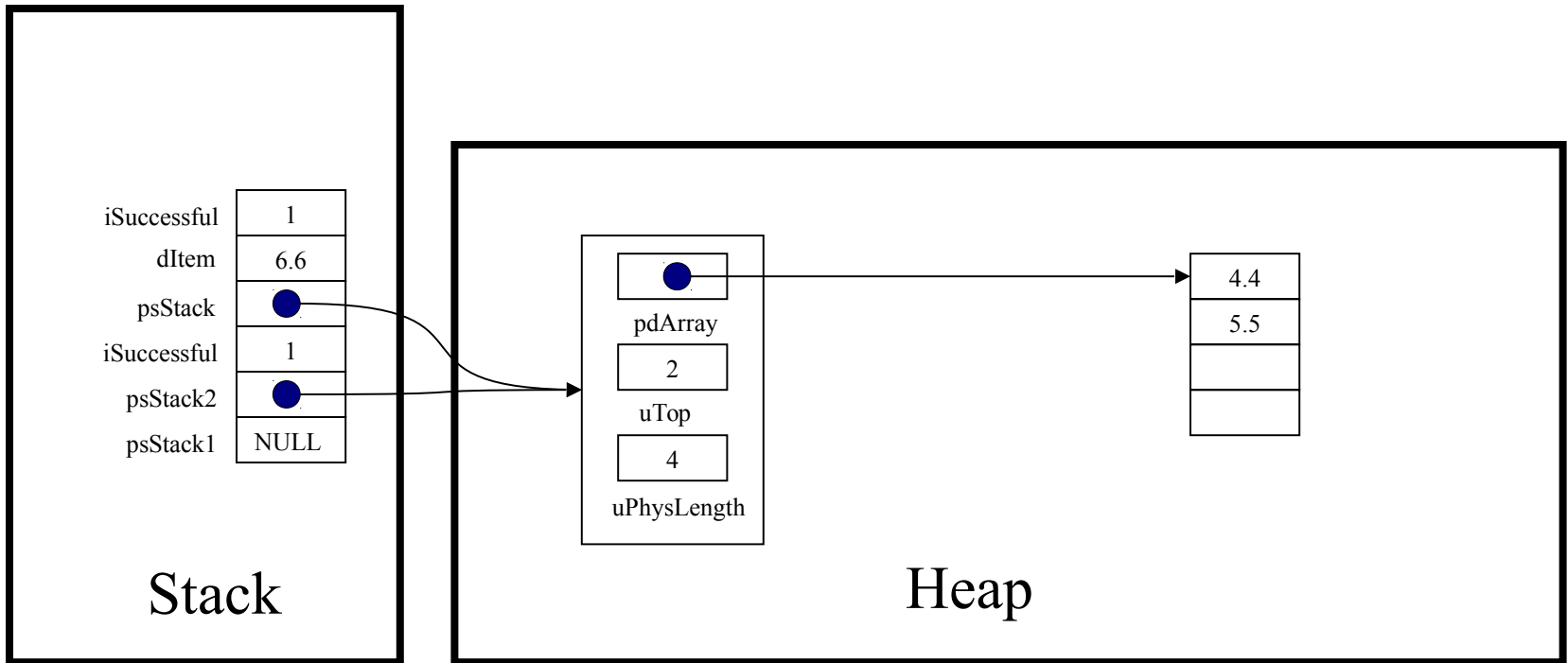

Princeton University
COS 217: Introduction to Programming Systems
Trace of teststack (Version 1)

```
(psStack->pdArray)[psStack->uTop] = dItem;
```

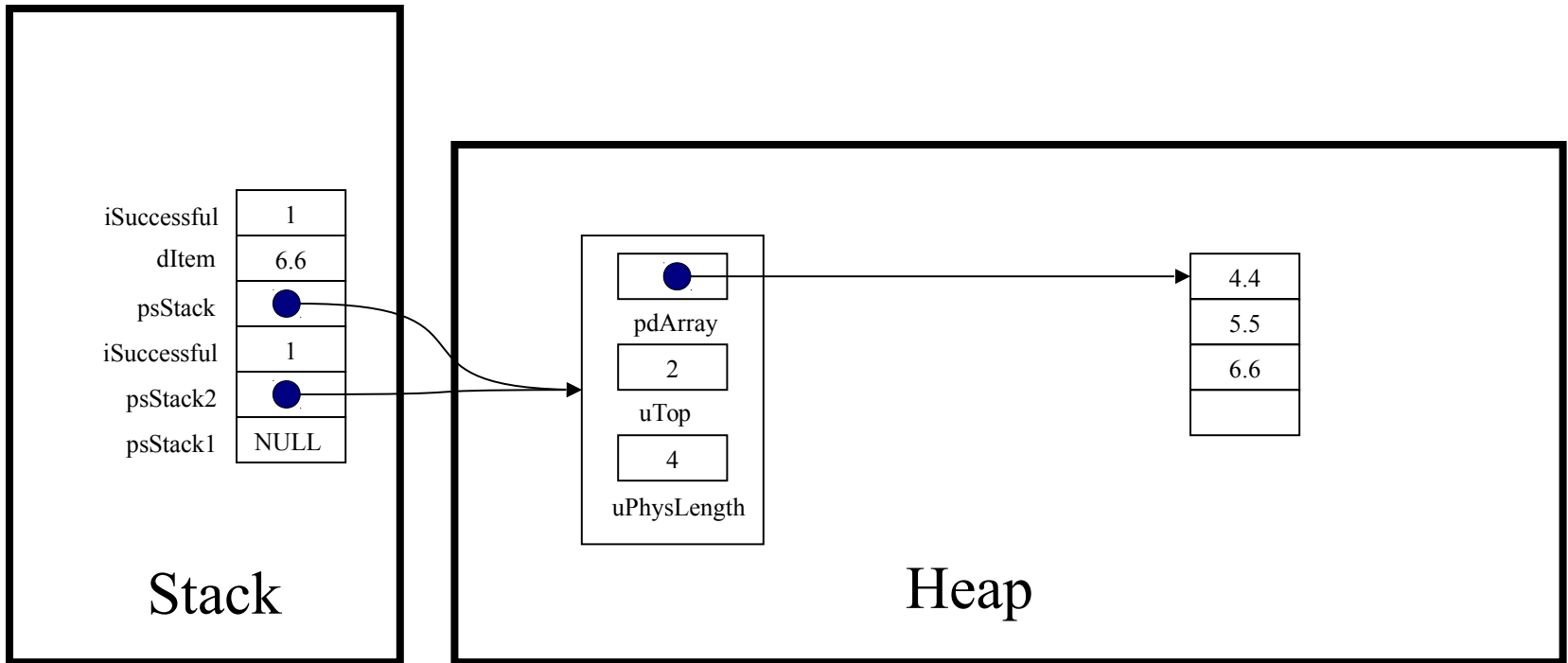

Princeton University
COS 217: Introduction to Programming Systems
Trace of teststack (Version 1)

```
(psStack->uTop) ++;
```

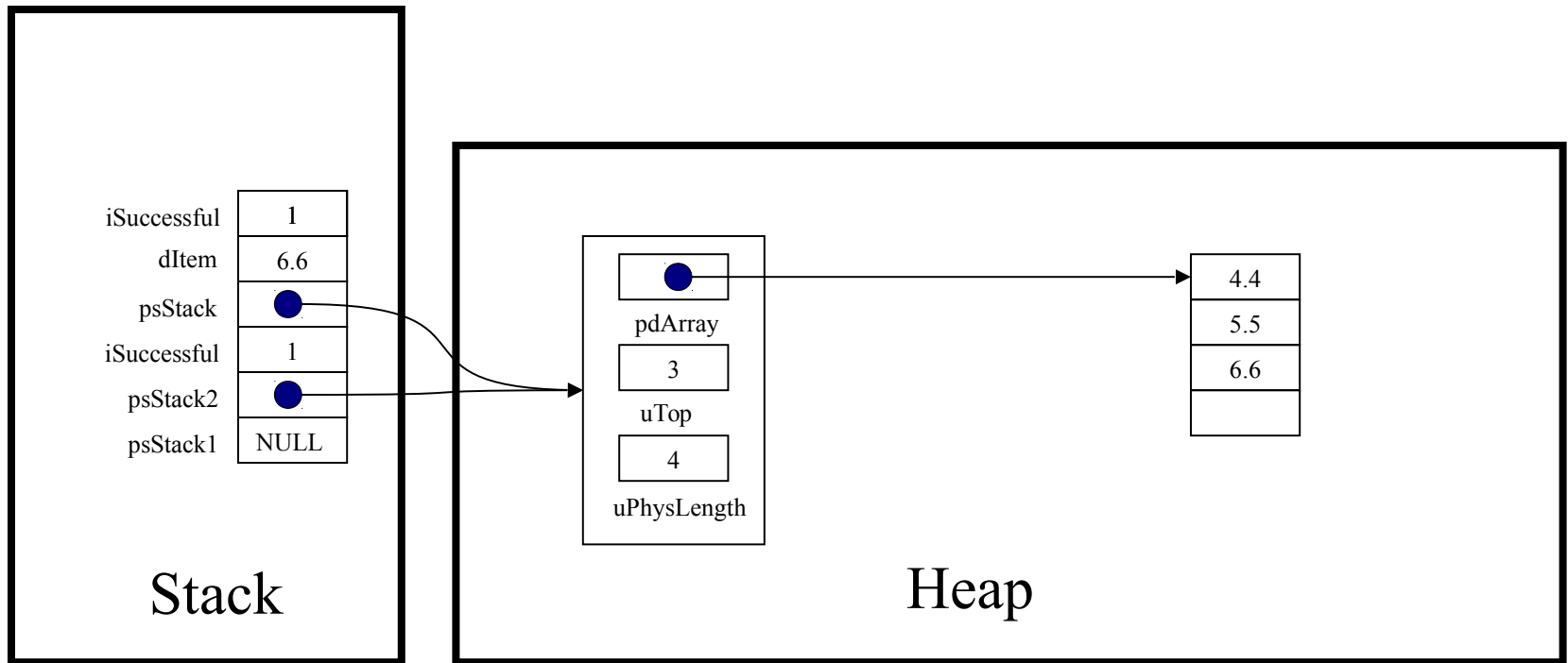

Princeton University
COS 217: Introduction to Programming Systems
Trace of teststack (Version 1)

```
return 1;
```

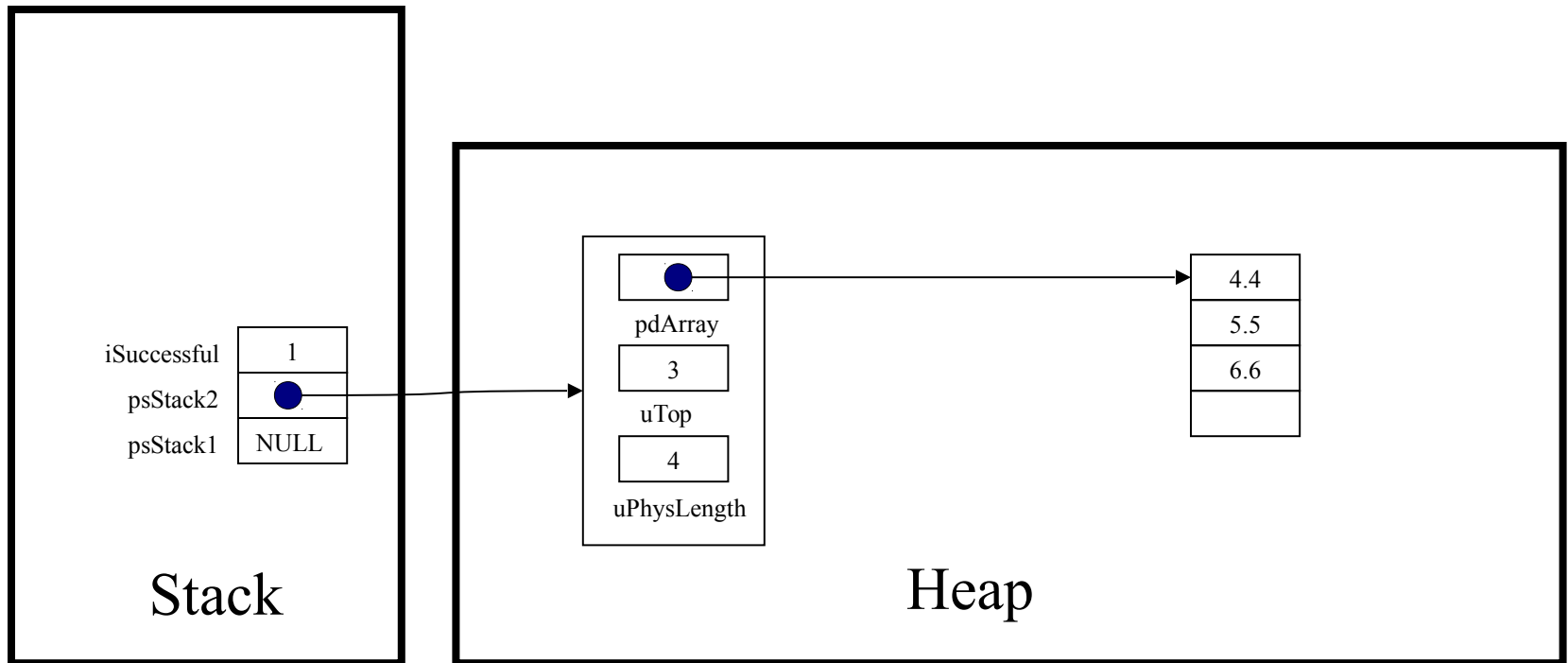

Princeton University
COS 217: Introduction to Programming Systems
Trace of teststack (Version 1)

```
iSuccessful = Stack_push(psStack2, 6.6);
```

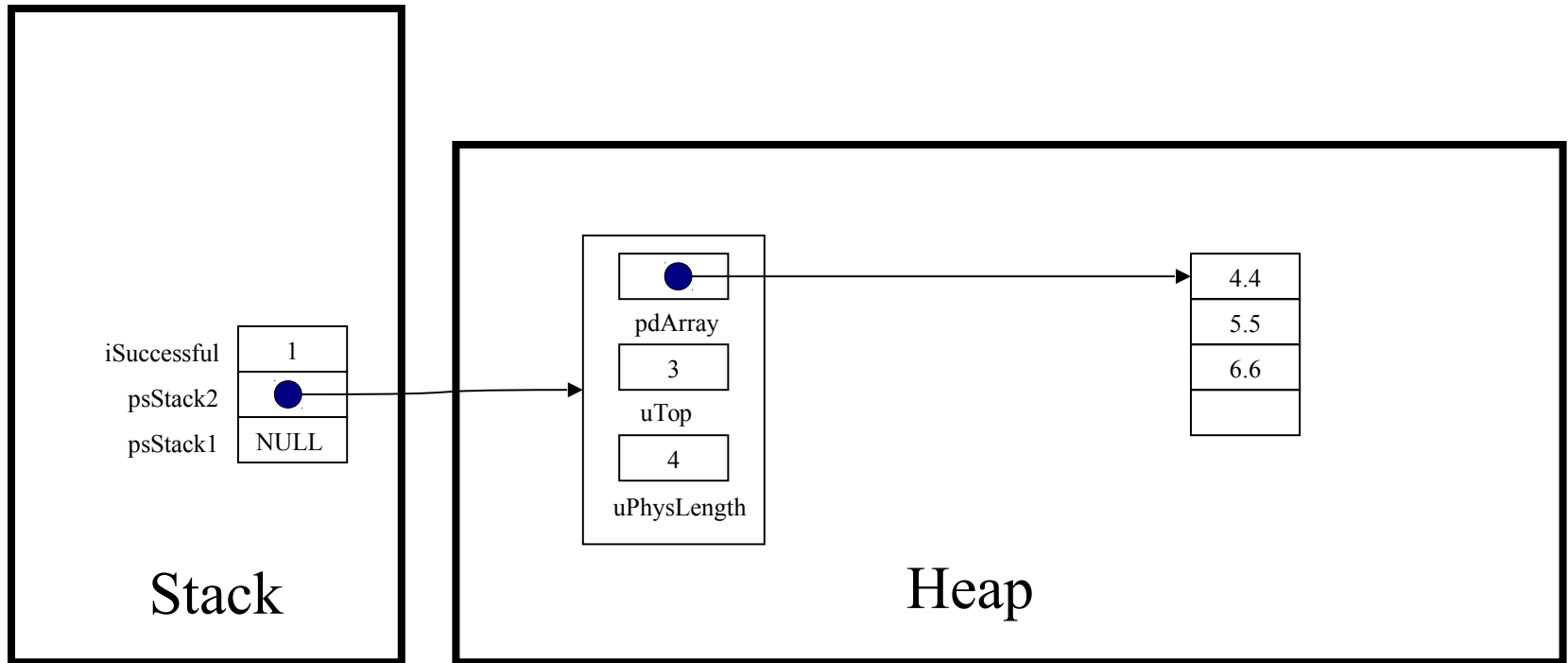

Princeton University
COS 217: Introduction to Programming Systems
Trace of teststack (Version 1)

```
if (! iSuccessful) handleMemoryError();
```

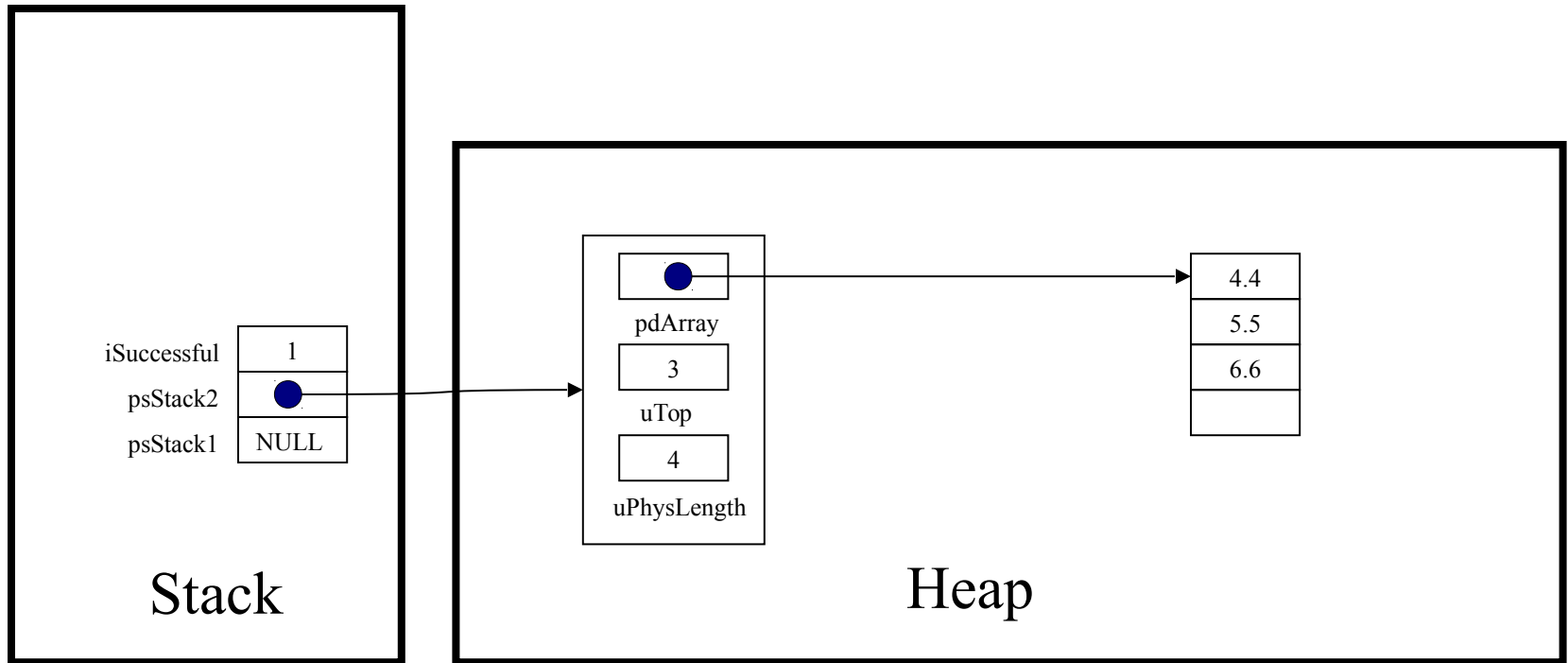

Princeton University
COS 217: Introduction to Programming Systems
Trace of teststack (Version 1)

```
while (! Stack_isEmpty(psStack2))  
    ...
```

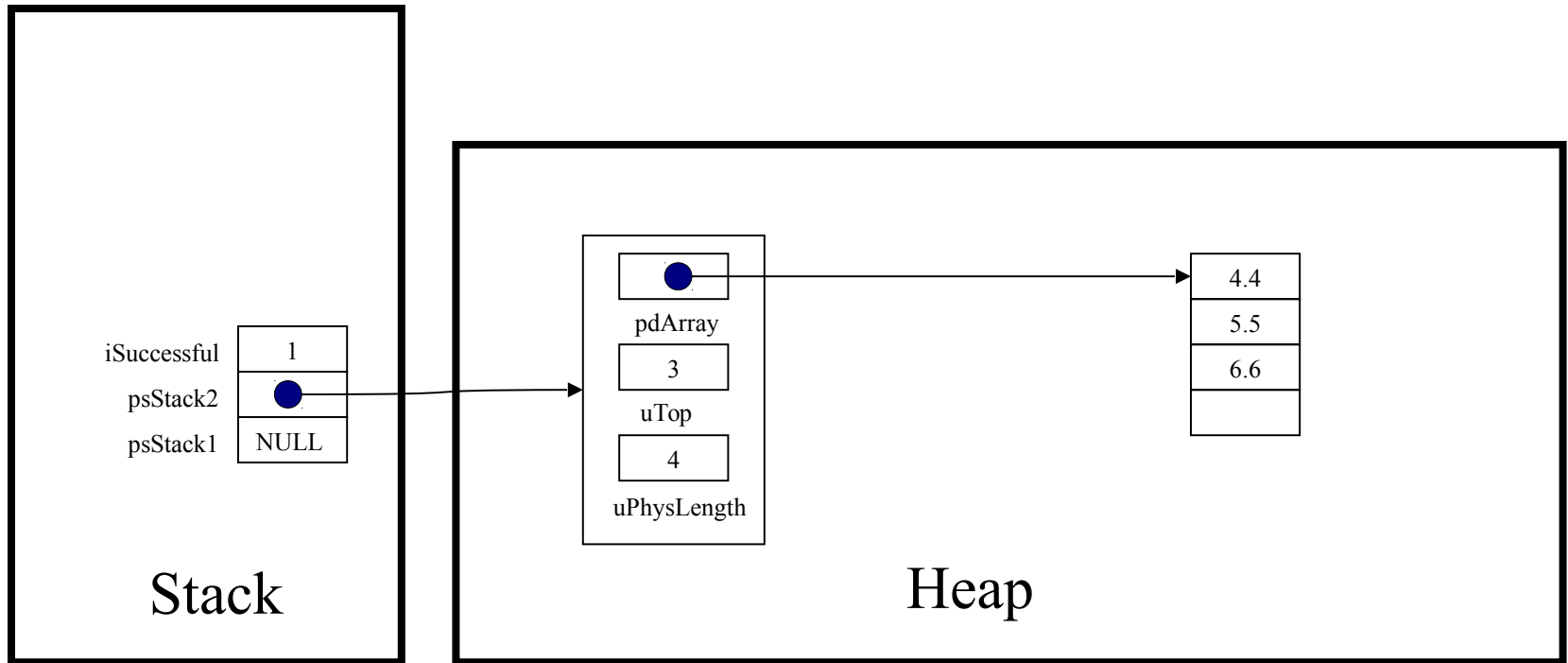

Princeton University
COS 217: Introduction to Programming Systems
Trace of teststack (Version 1)

```
int Stack_isEmpty(struct Stack *psStack)
```

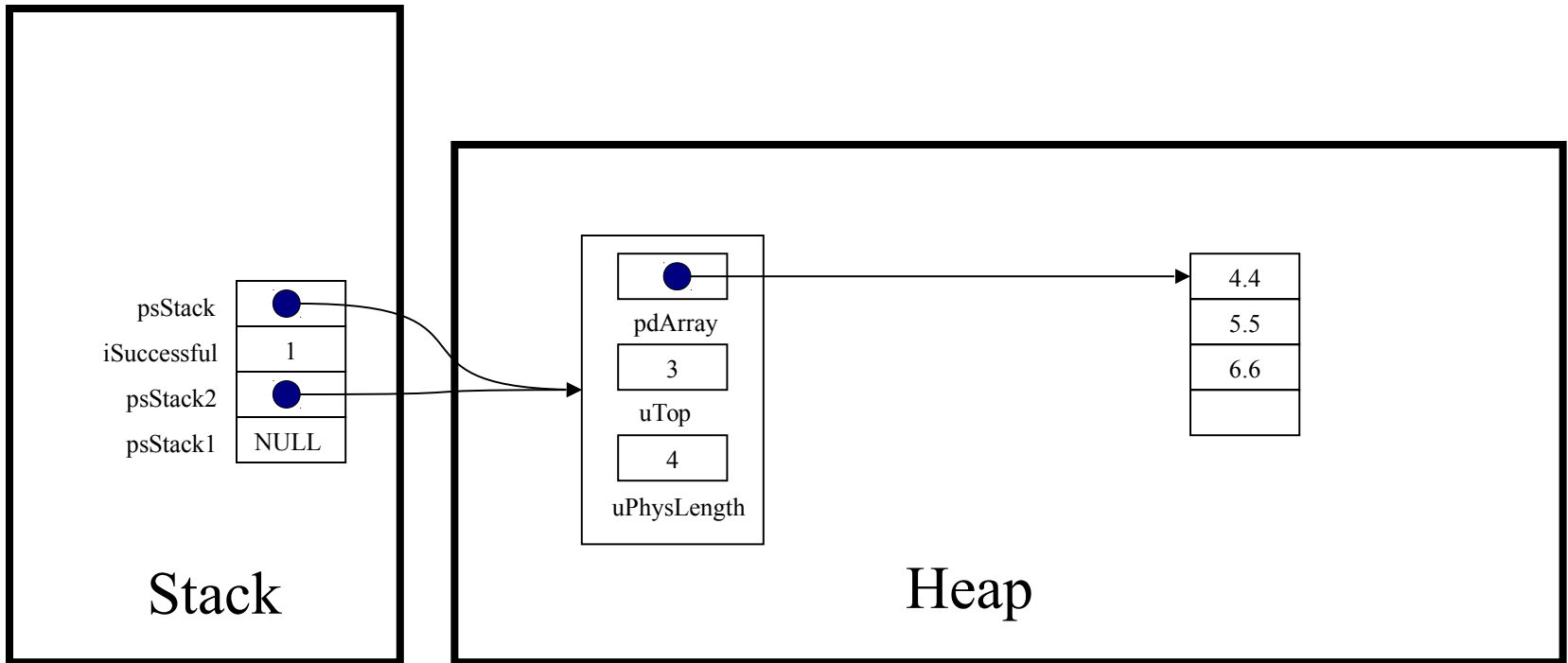

Princeton University
COS 217: Introduction to Programming Systems
Trace of teststack (Version 1)

```
assert (psStack != NULL);
```

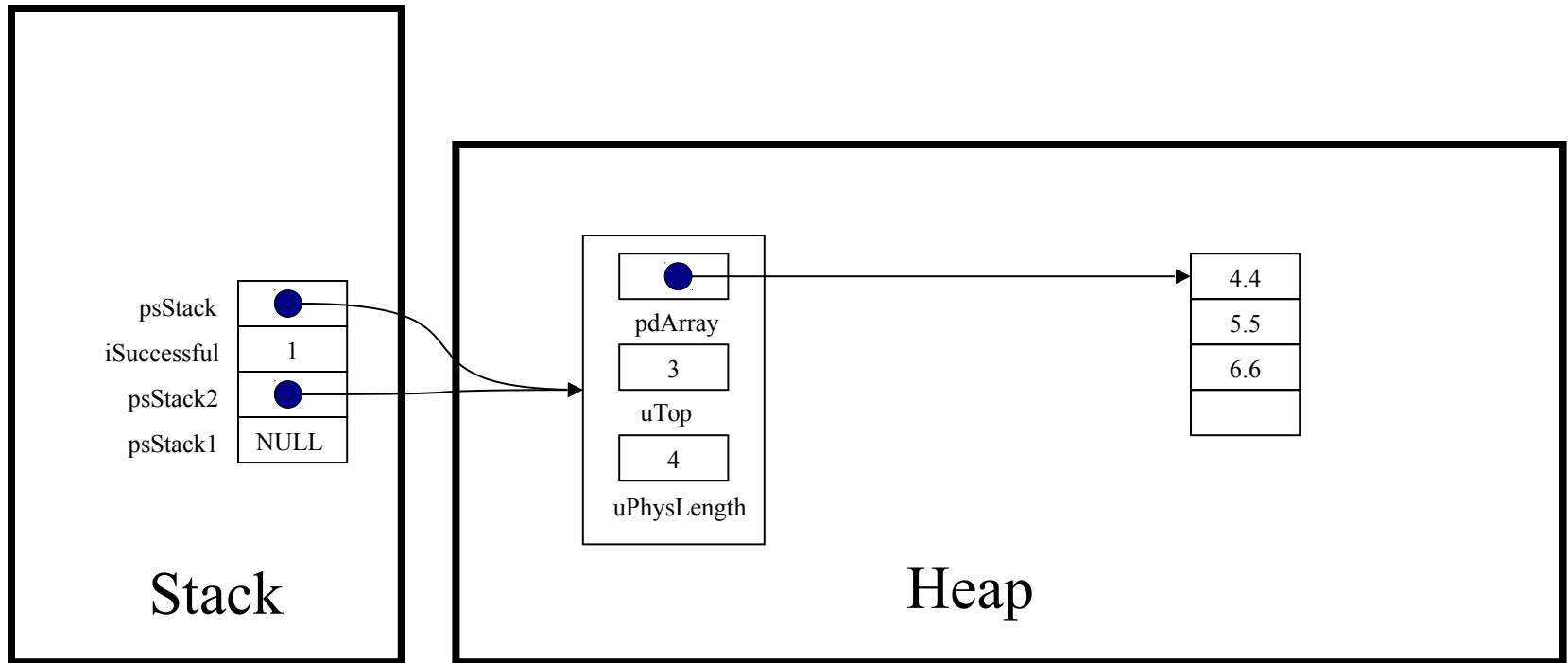

Princeton University
COS 217: Introduction to Programming Systems
Trace of teststack (Version 1)

```
return psStack->uTop == 0;
```

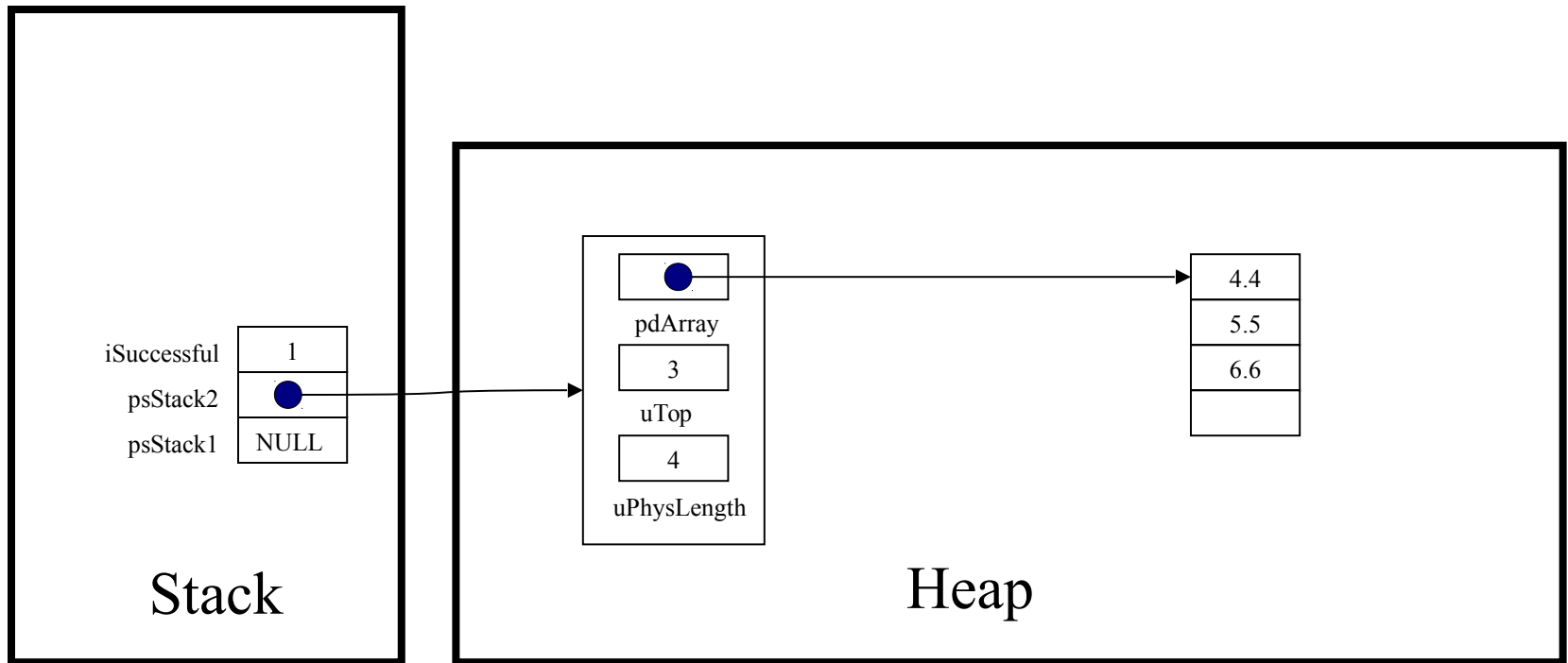

Princeton University
COS 217: Introduction to Programming Systems
Trace of teststack (Version 1)

```
while (! Stack_isEmpty(psStack2))
```

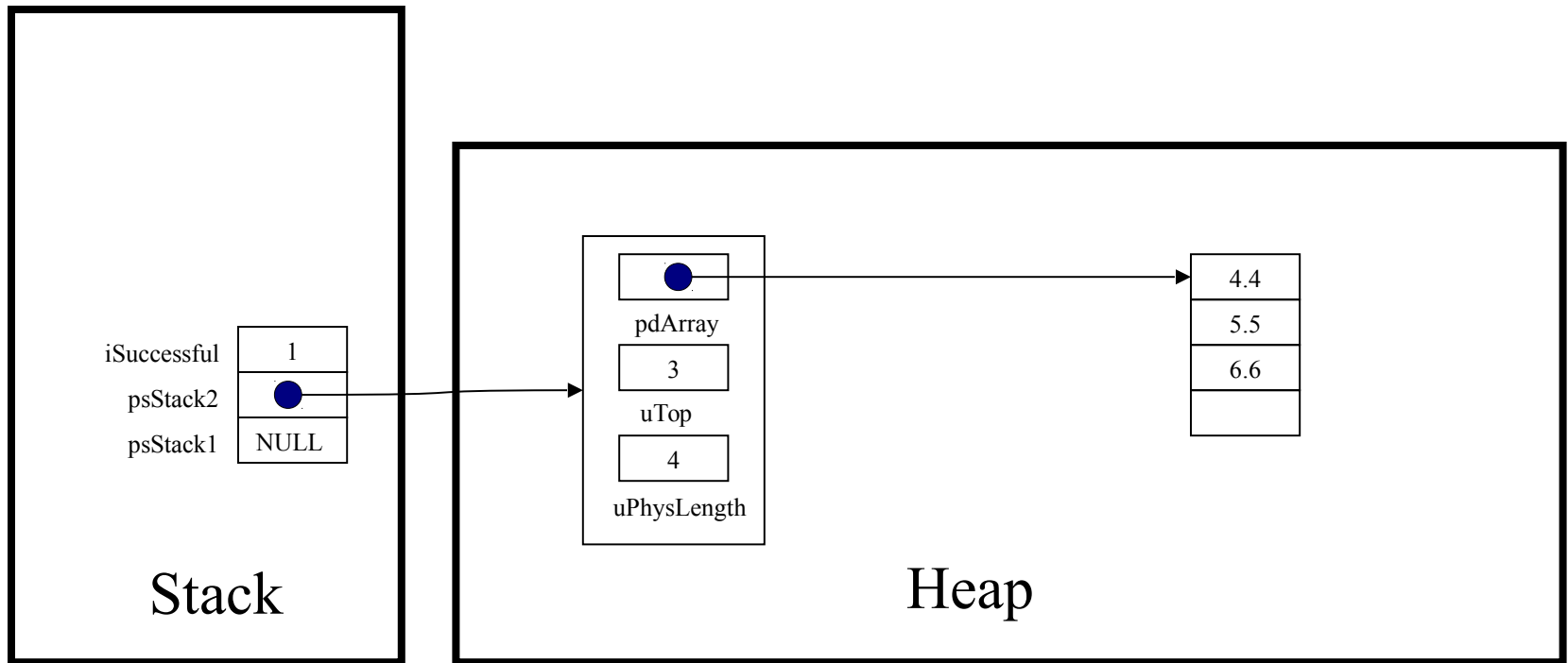

Princeton University
COS 217: Introduction to Programming Systems
Trace of teststack (Version 1)

```
printf("%g\n", Stack_pop(psStack2));
```

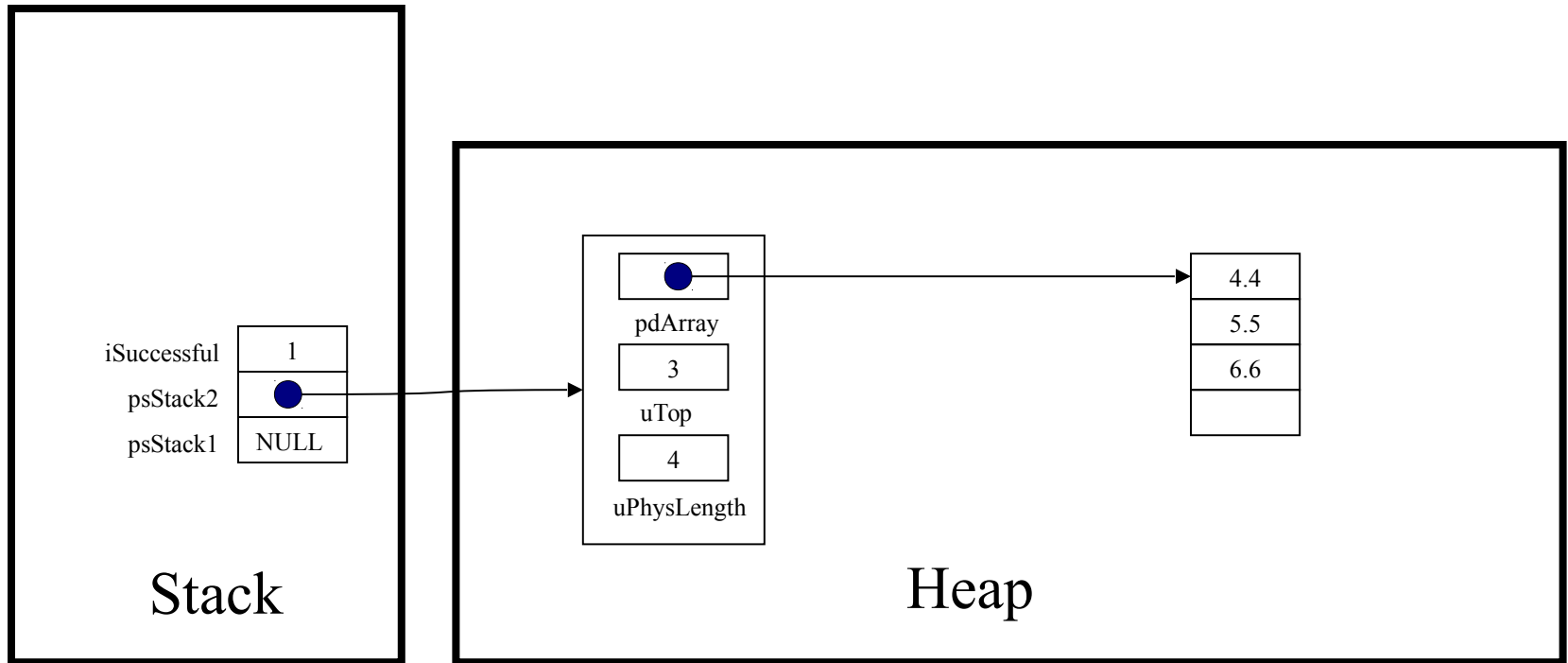

Princeton University
COS 217: Introduction to Programming Systems
Trace of teststack (Version 1)

```
double Stack_pop(struct Stack *psStack)
```

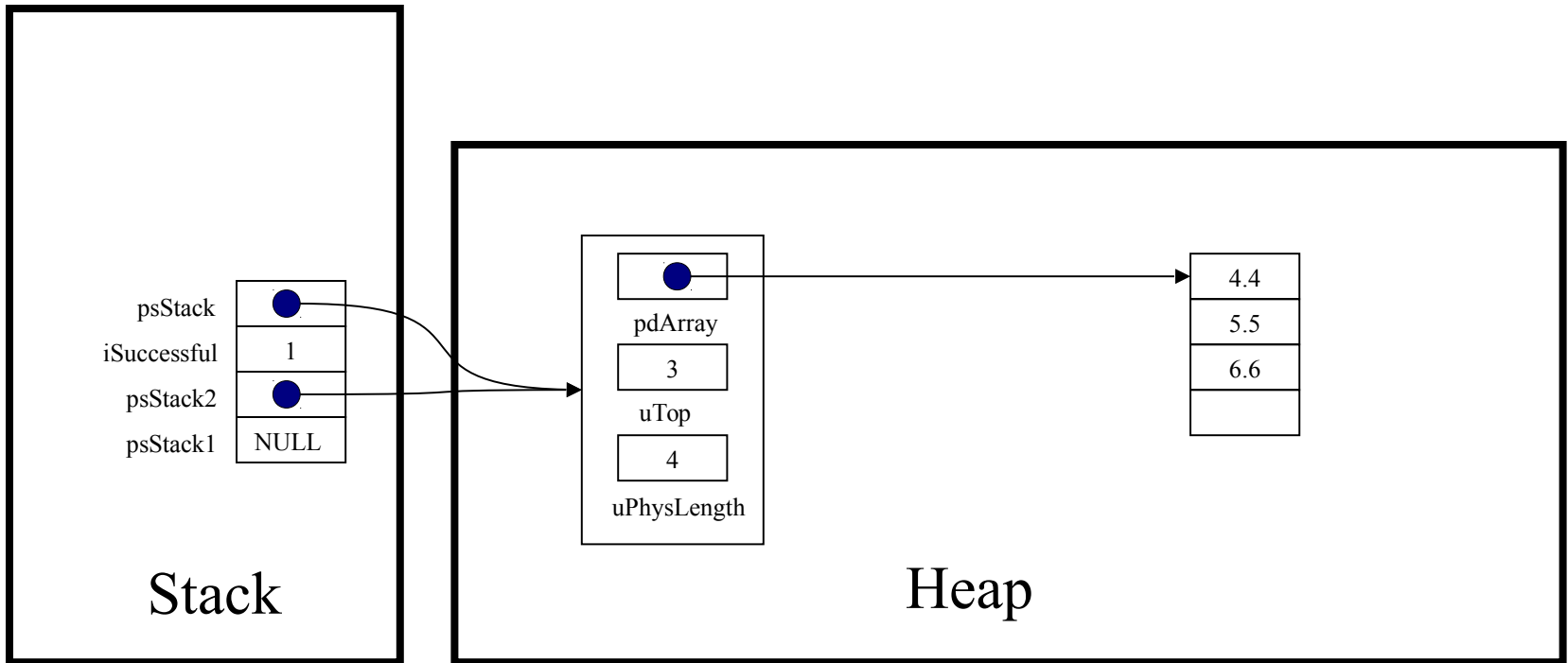

Princeton University
COS 217: Introduction to Programming Systems
Trace of teststack (Version 1)

```
assert (psStack != NULL);
```

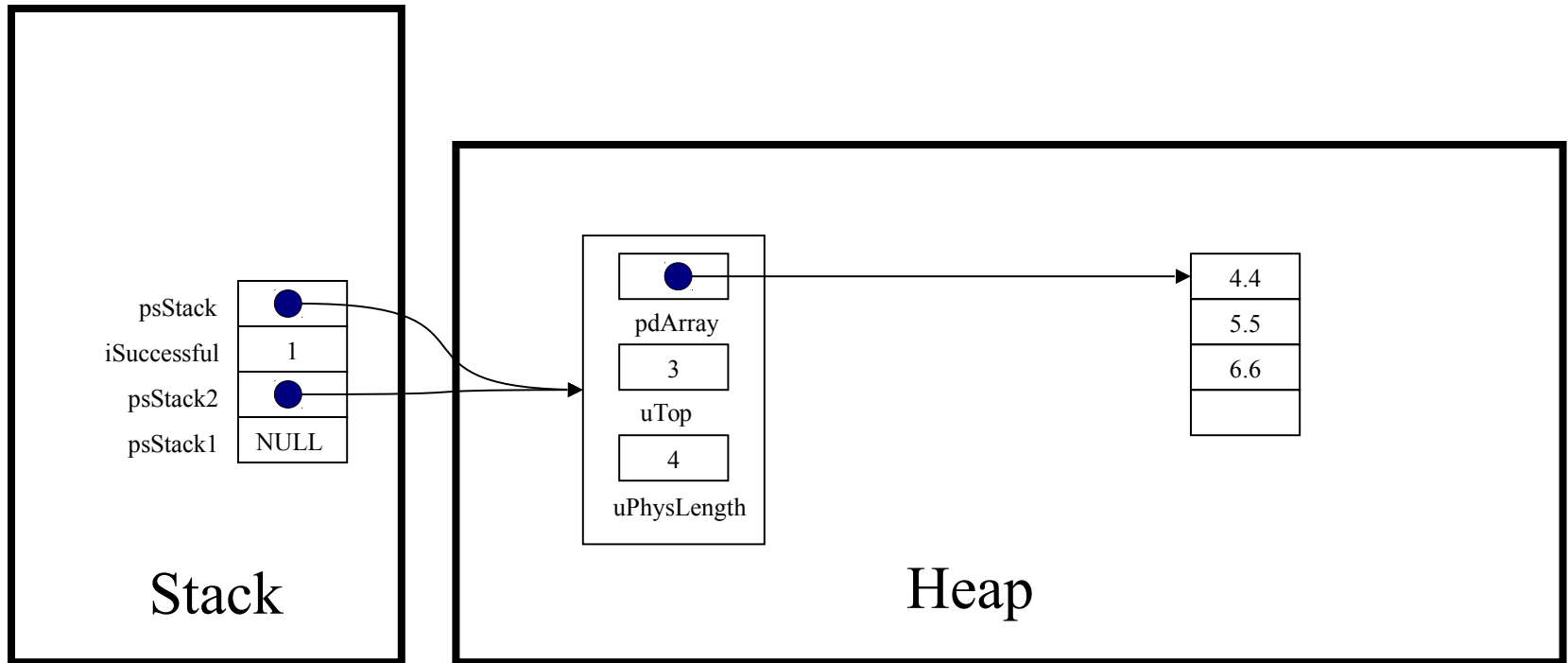

Princeton University
COS 217: Introduction to Programming Systems
Trace of teststack (Version 1)

```
assert (psStack->uTop > 0);
```

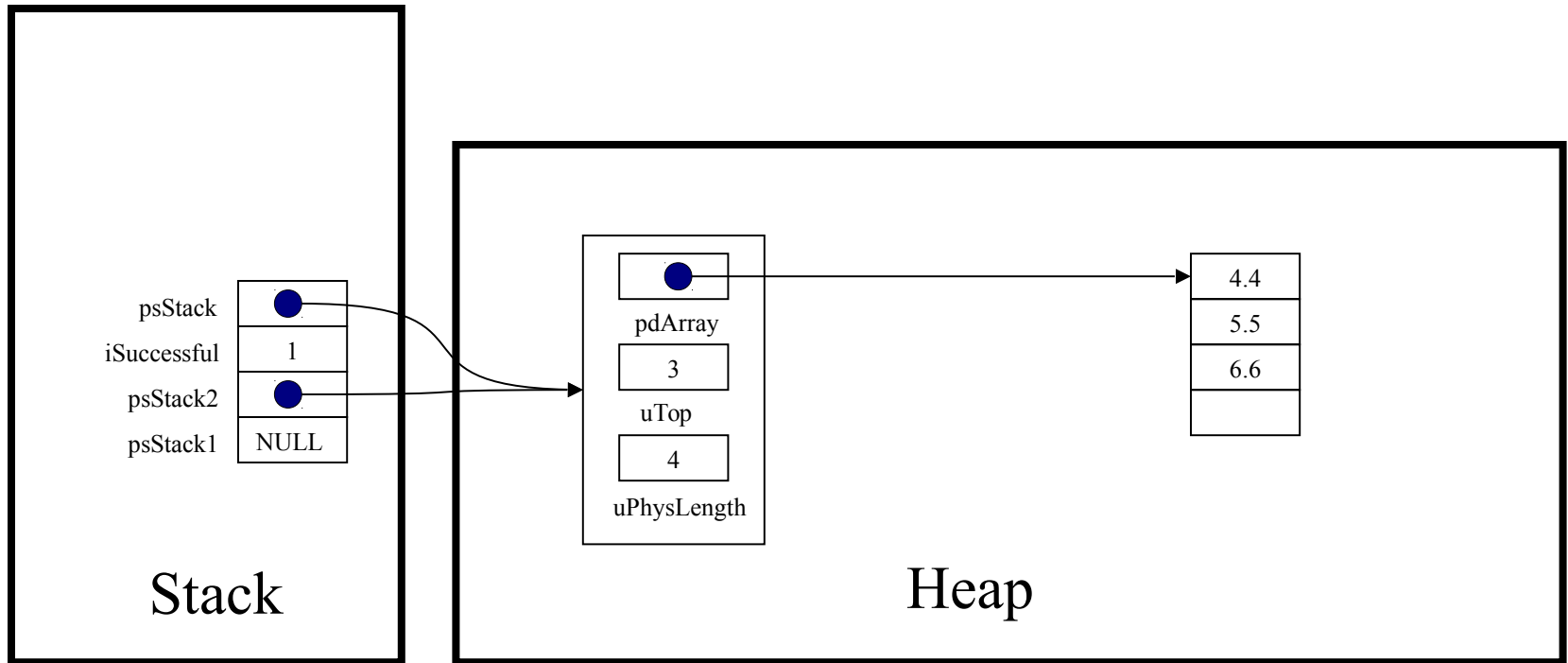

Princeton University
COS 217: Introduction to Programming Systems
Trace of teststack (Version 1)

```
(psStack->uTop) --;
```

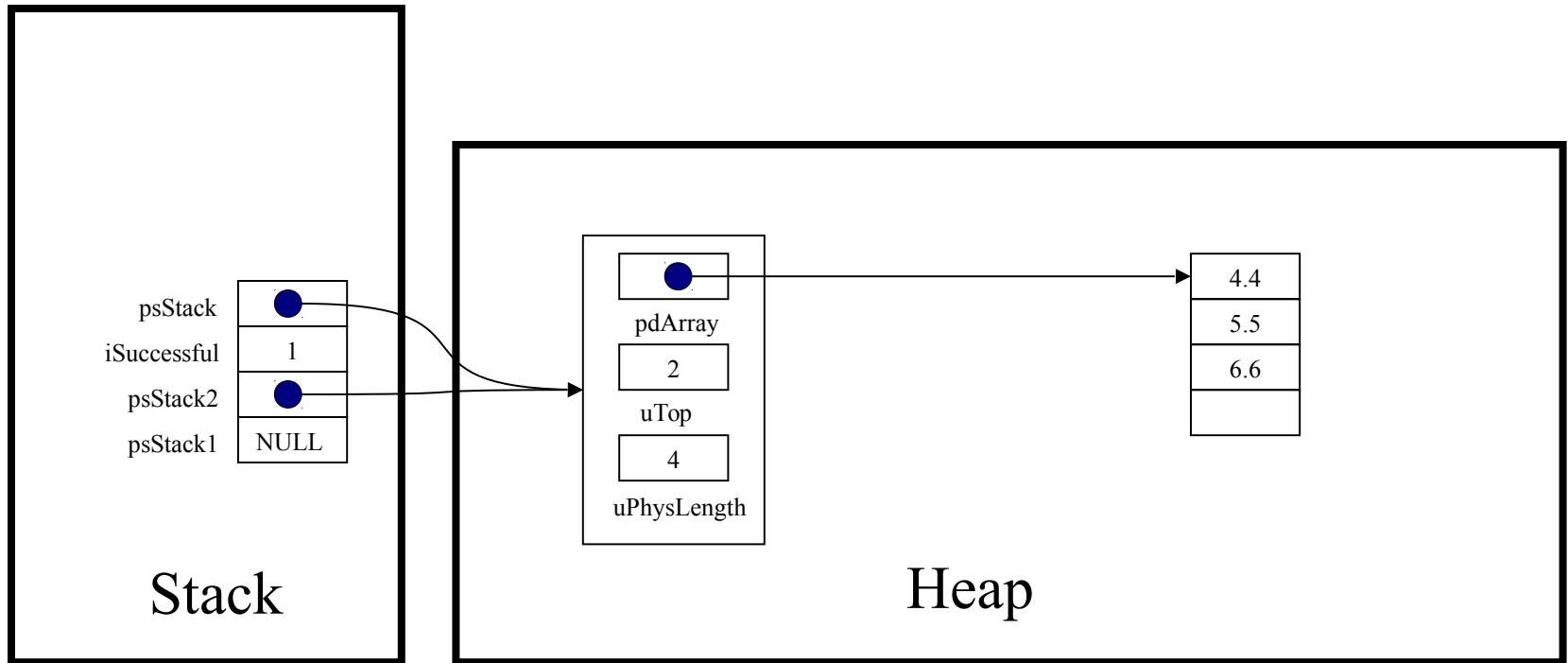

Princeton University
COS 217: Introduction to Programming Systems
Trace of teststack (Version 1)

```
return (psStack->pdArray)[psStack->uTop];
```

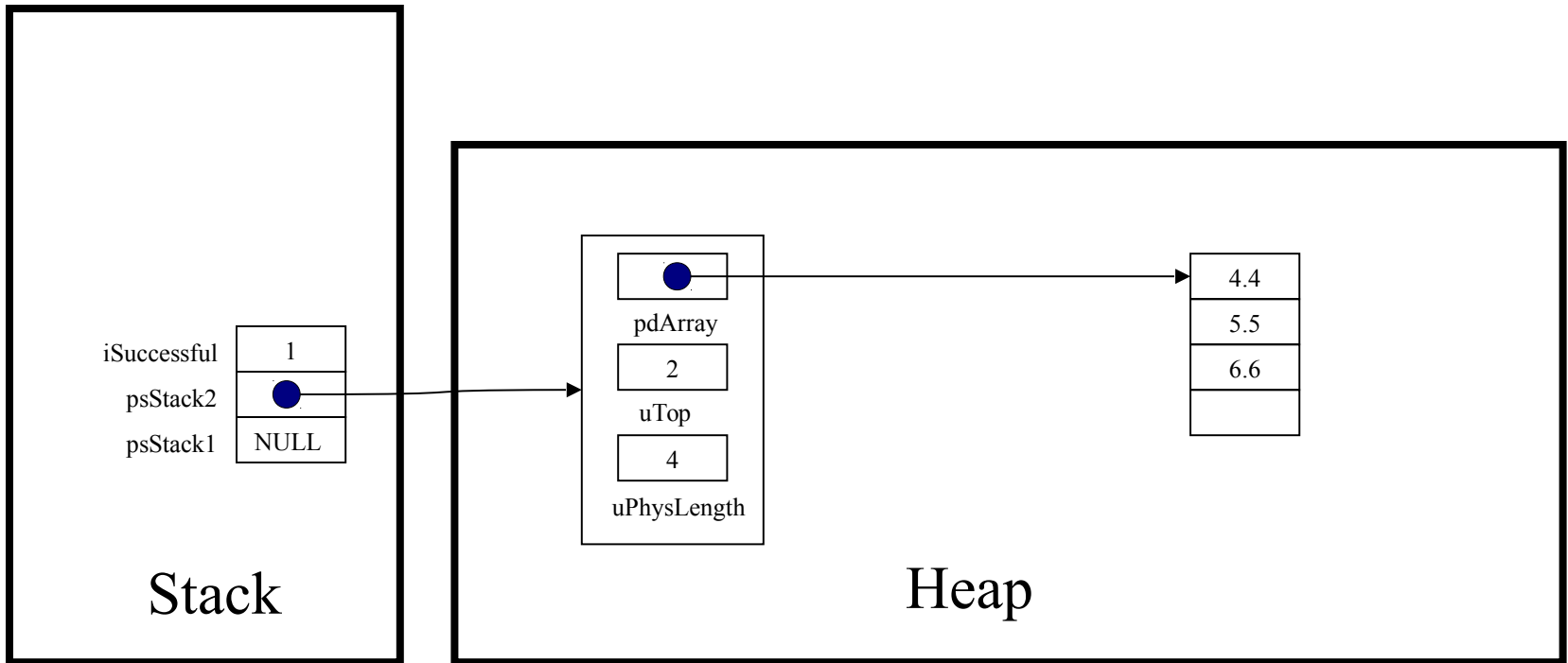

Princeton University
COS 217: Introduction to Programming Systems
Trace of teststack (Version 1)

```
printf("%g\n", Stack_pop(psStack2));
```

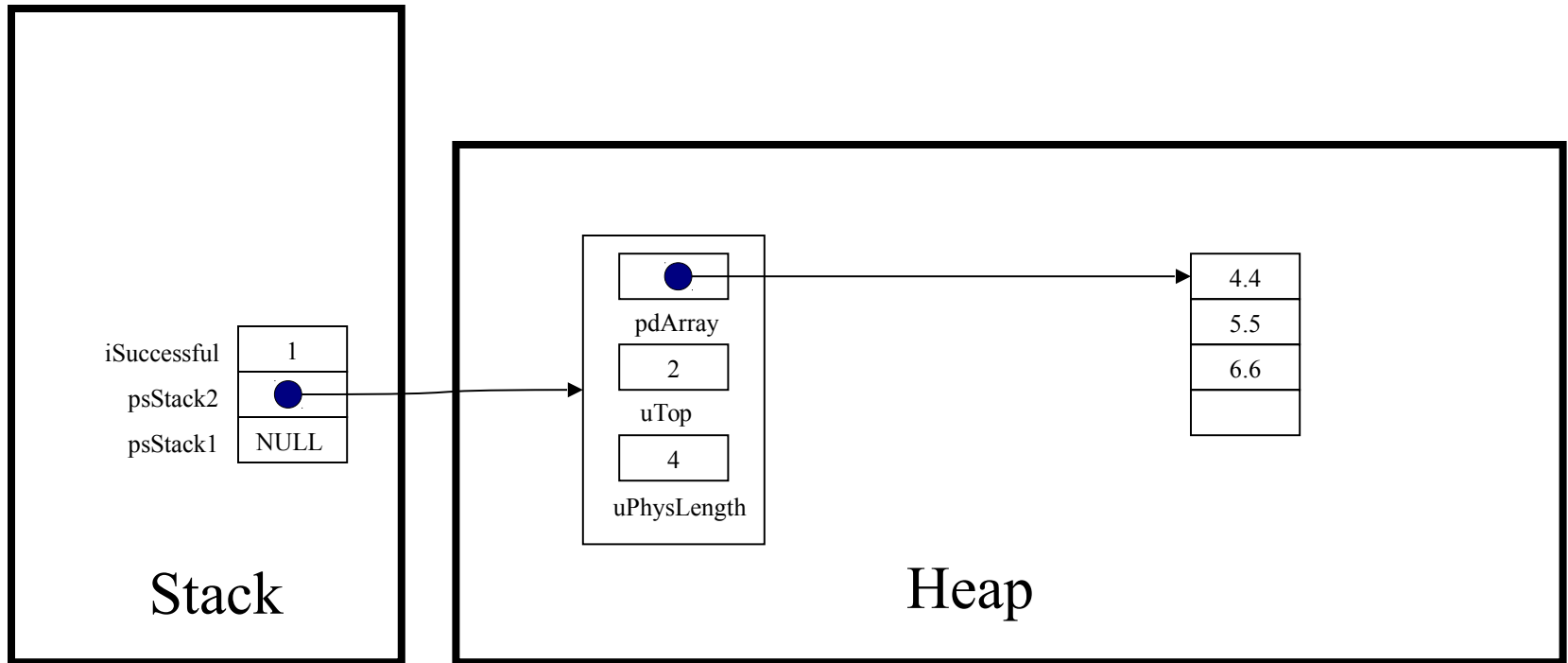

Princeton University
COS 217: Introduction to Programming Systems
Trace of teststack (Version 1)

```
while (! Stack_isEmpty(psStack2))  
    ...
```

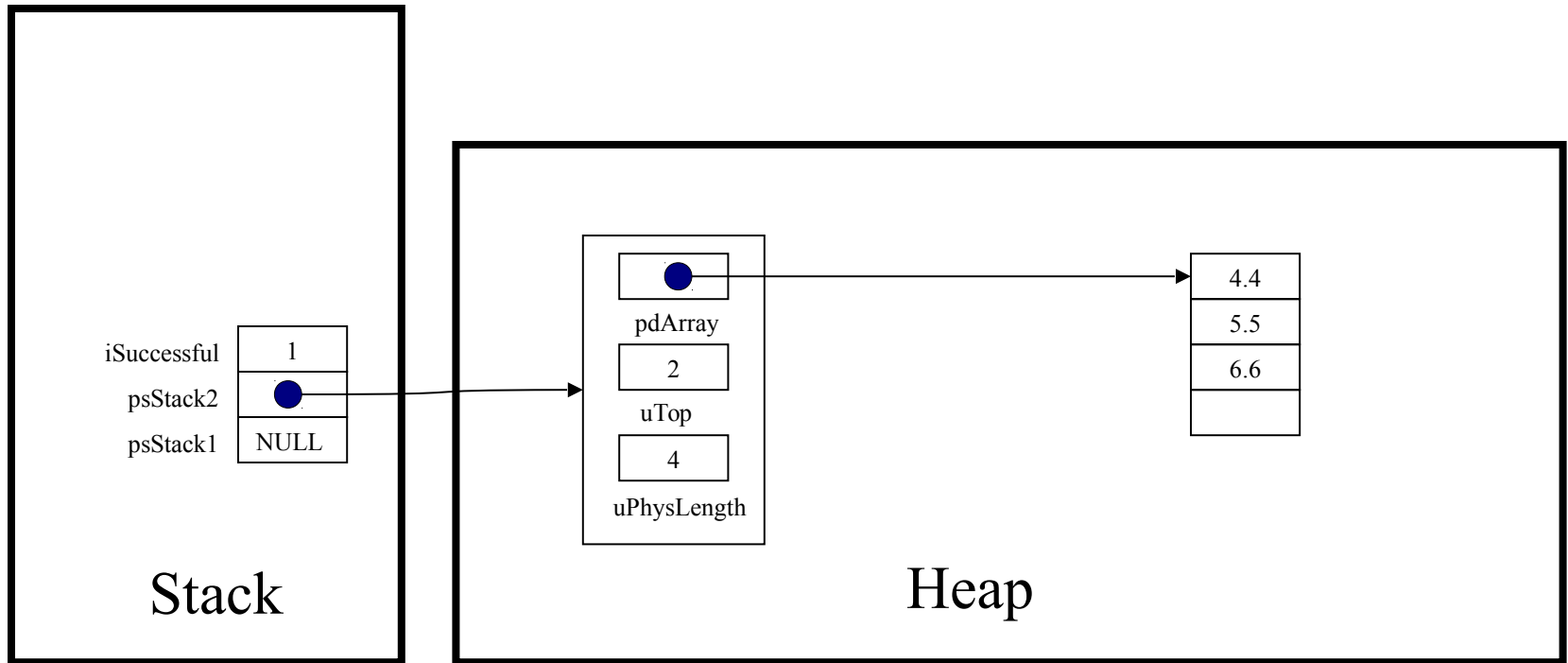

Princeton University
COS 217: Introduction to Programming Systems
Trace of teststack (Version 1)

```
int Stack_isEmpty(struct Stack *psStack)
```

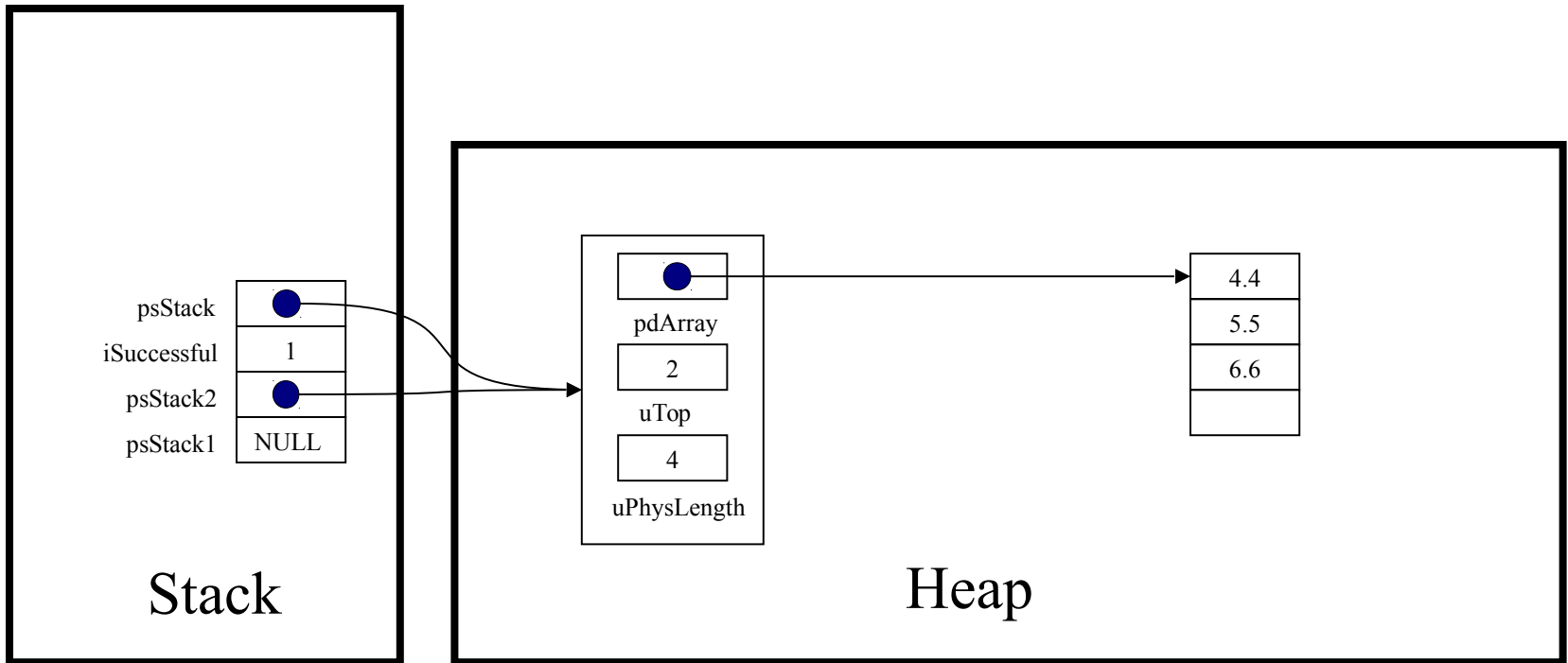

Princeton University
COS 217: Introduction to Programming Systems
Trace of teststack (Version 1)

```
assert (psStack != NULL);
```

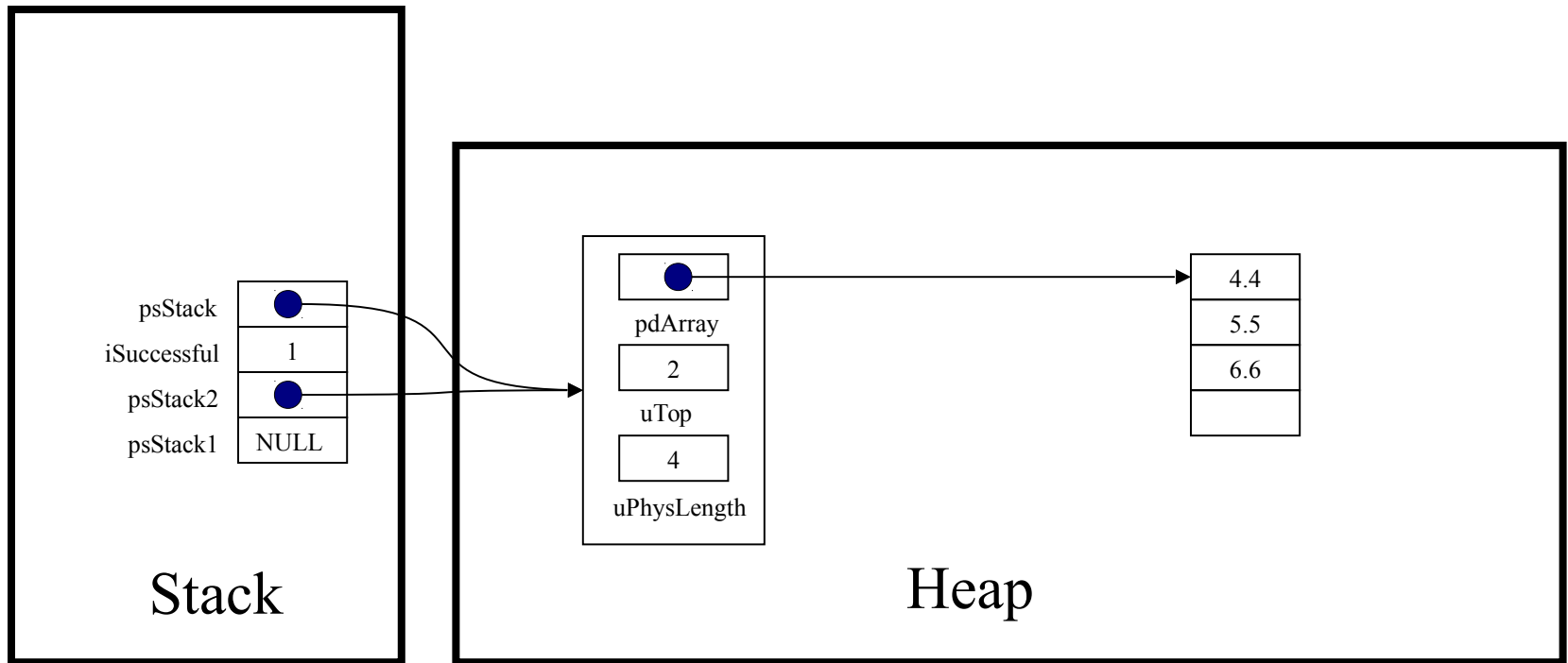

Princeton University
COS 217: Introduction to Programming Systems
Trace of teststack (Version 1)

```
return psStack->uTop == 0;
```

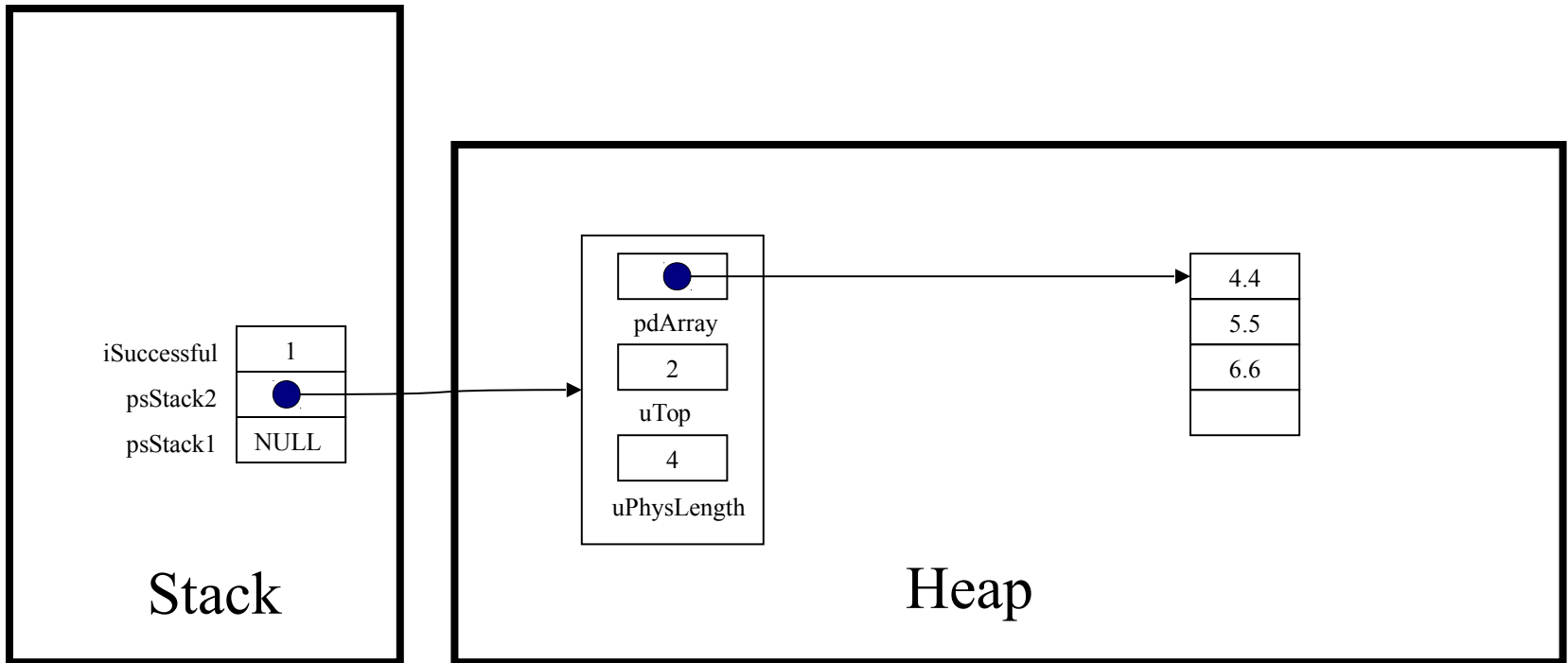

Princeton University
COS 217: Introduction to Programming Systems
Trace of teststack (Version 1)

```
while (! Stack_isEmpty(psStack2))
```

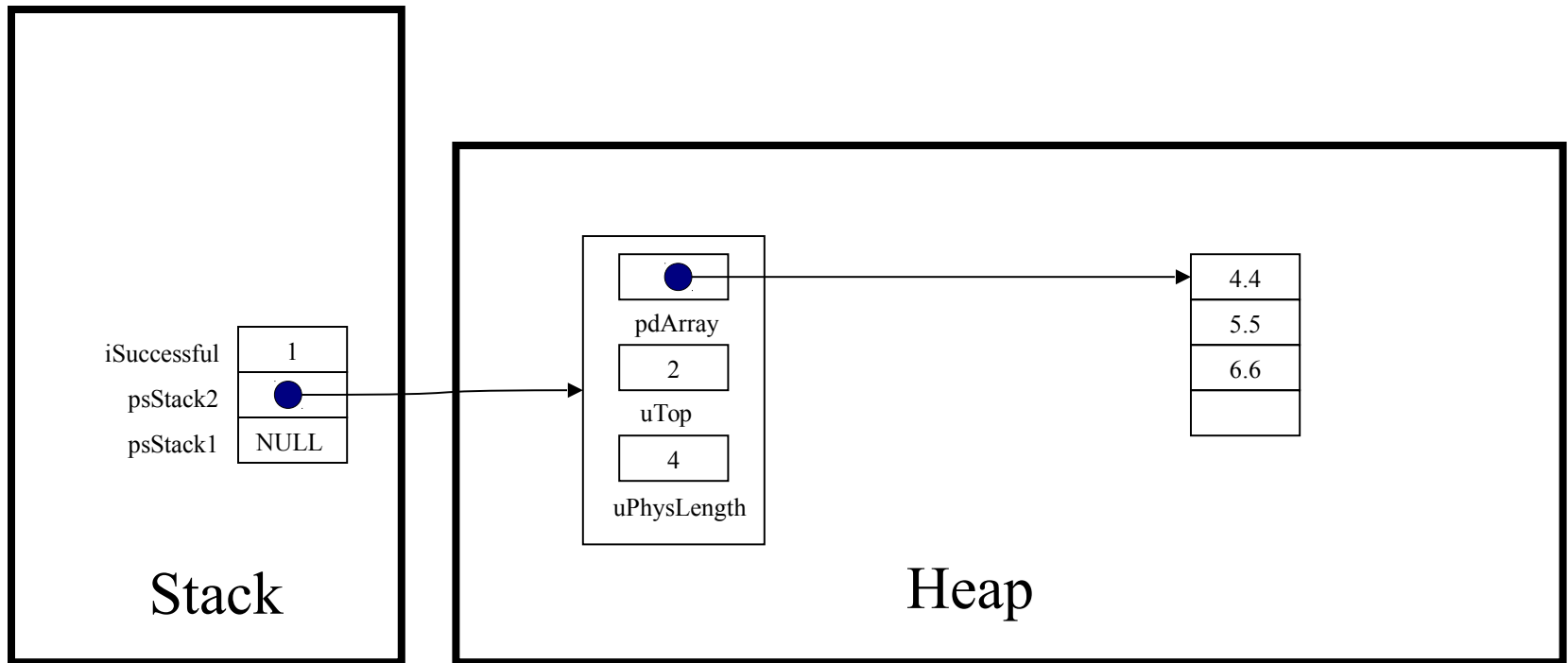

Princeton University
COS 217: Introduction to Programming Systems
Trace of teststack (Version 1)

```
printf("%g\n", Stack_pop(psStack2));
```

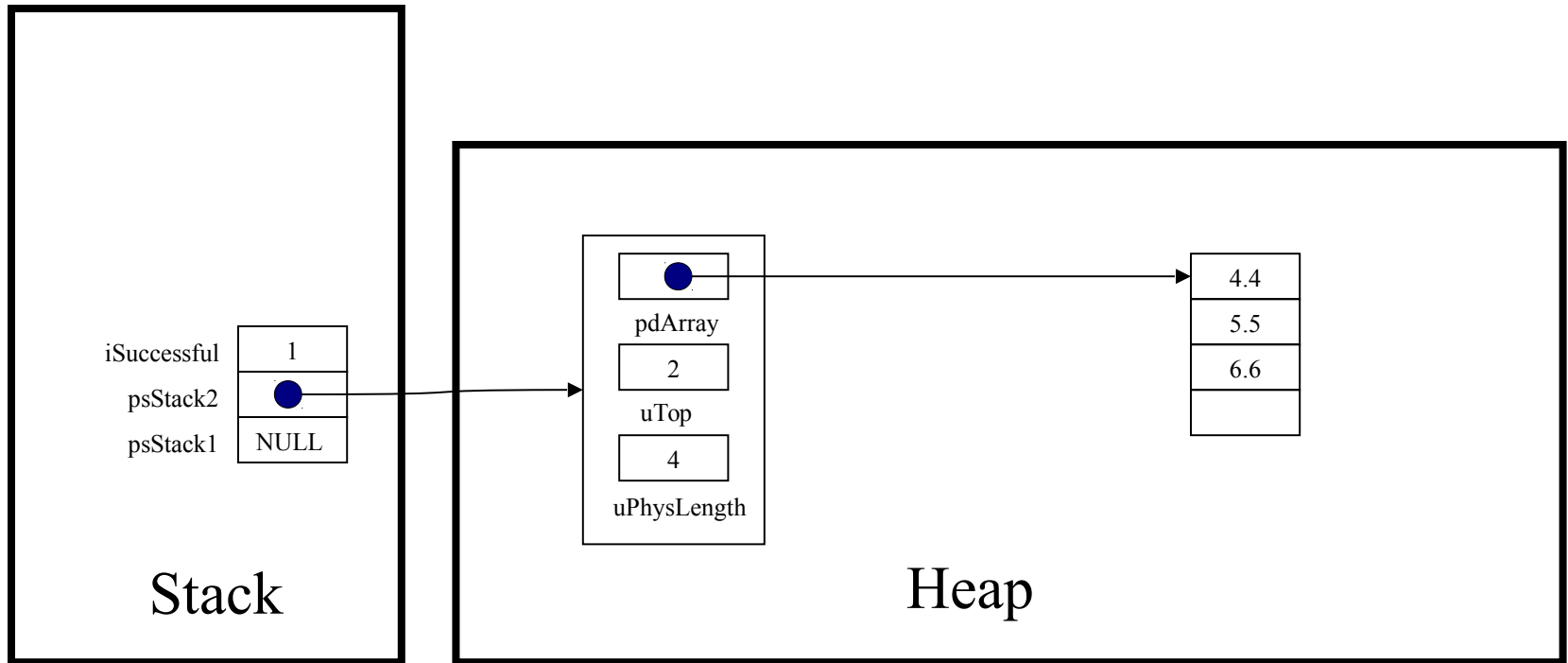

Princeton University
COS 217: Introduction to Programming Systems
Trace of teststack (Version 1)

```
double Stack_pop(struct Stack *psStack)
```

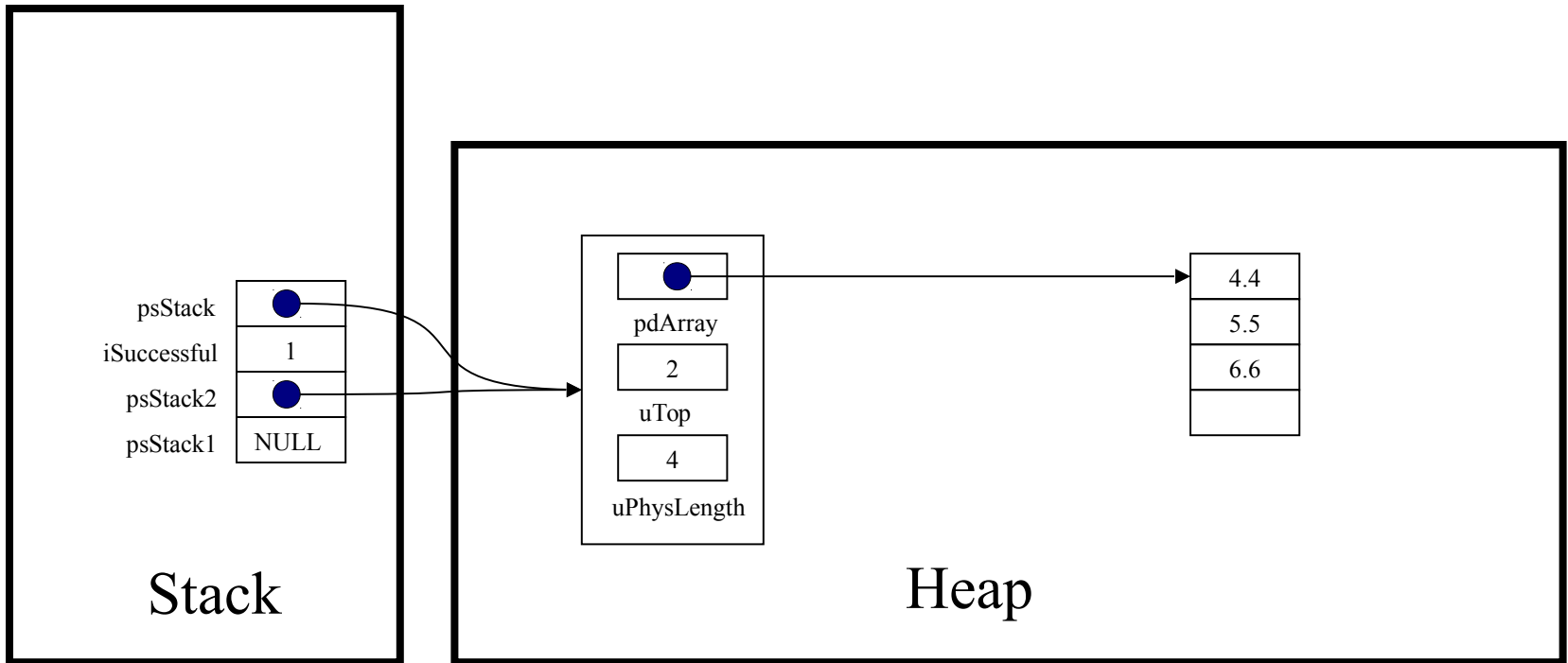

Princeton University
COS 217: Introduction to Programming Systems
Trace of teststack (Version 1)

```
assert (psStack != NULL);
```

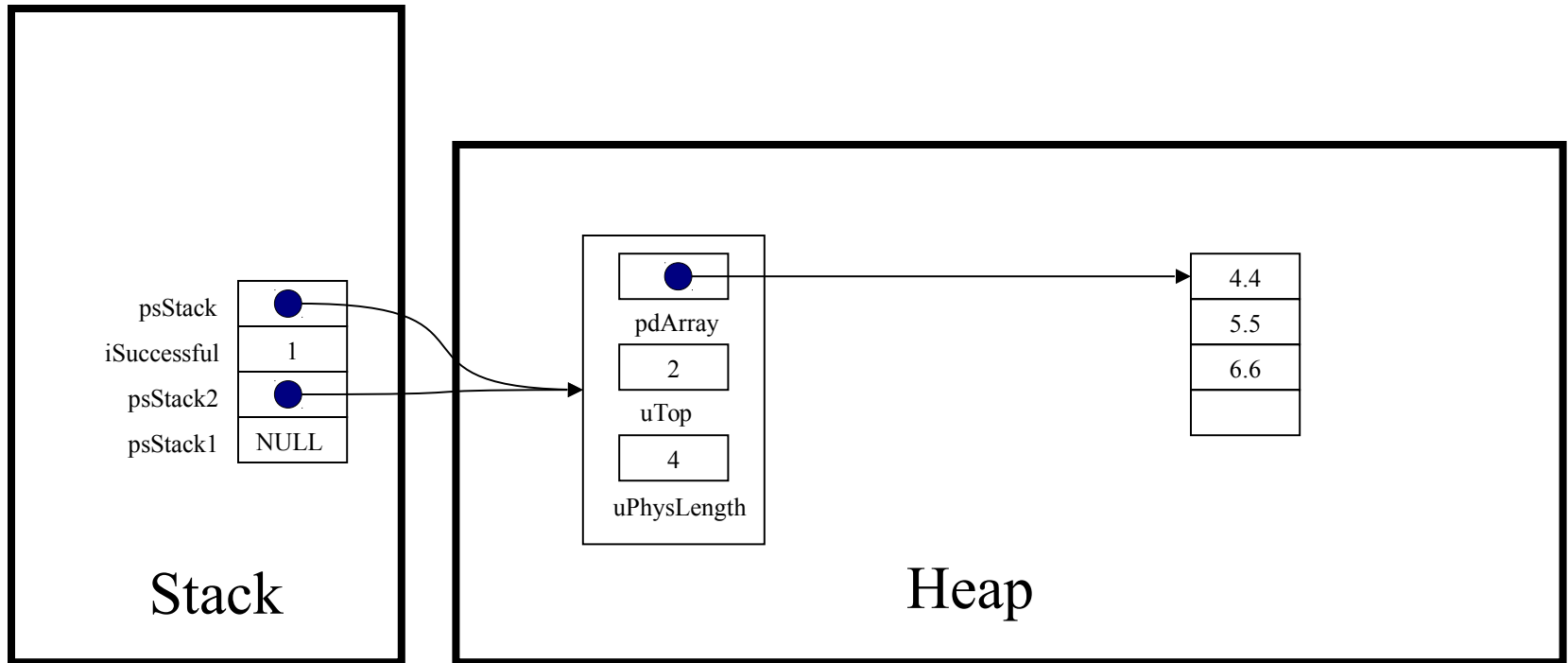

Princeton University
COS 217: Introduction to Programming Systems
Trace of teststack (Version 1)

```
assert (psStack->uTop > 0);
```

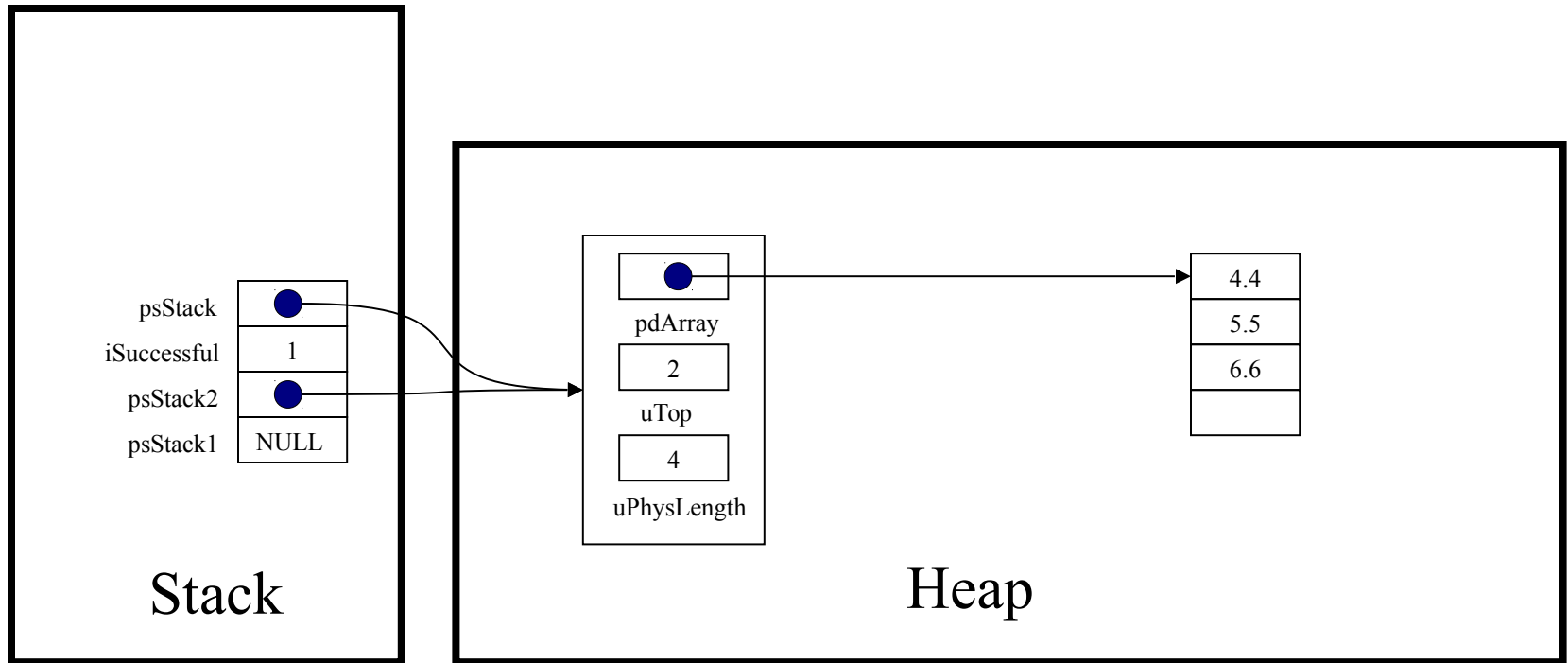

Princeton University
COS 217: Introduction to Programming Systems
Trace of teststack (Version 1)

```
(psStack->uTop) --;
```

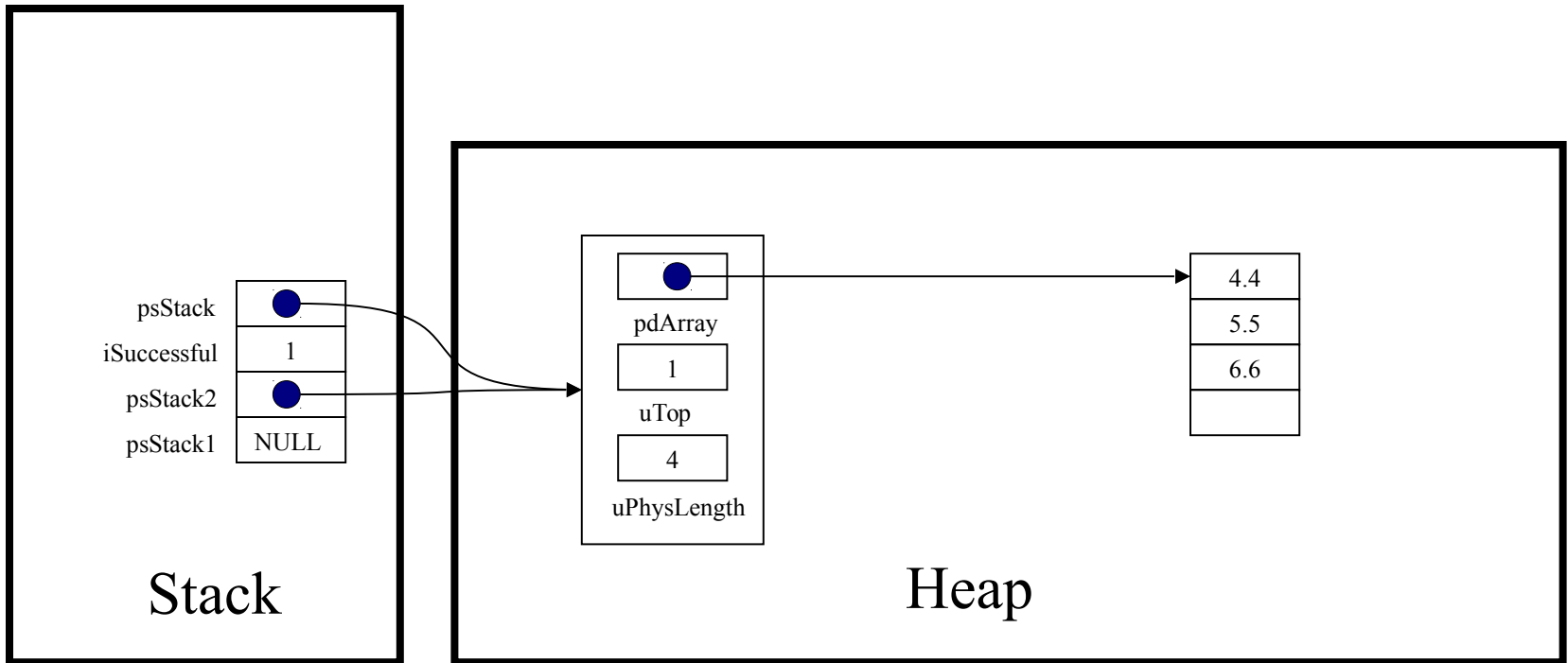

Princeton University
COS 217: Introduction to Programming Systems
Trace of teststack (Version 1)

```
return (psStack->pdArray)[psStack->uTop];
```

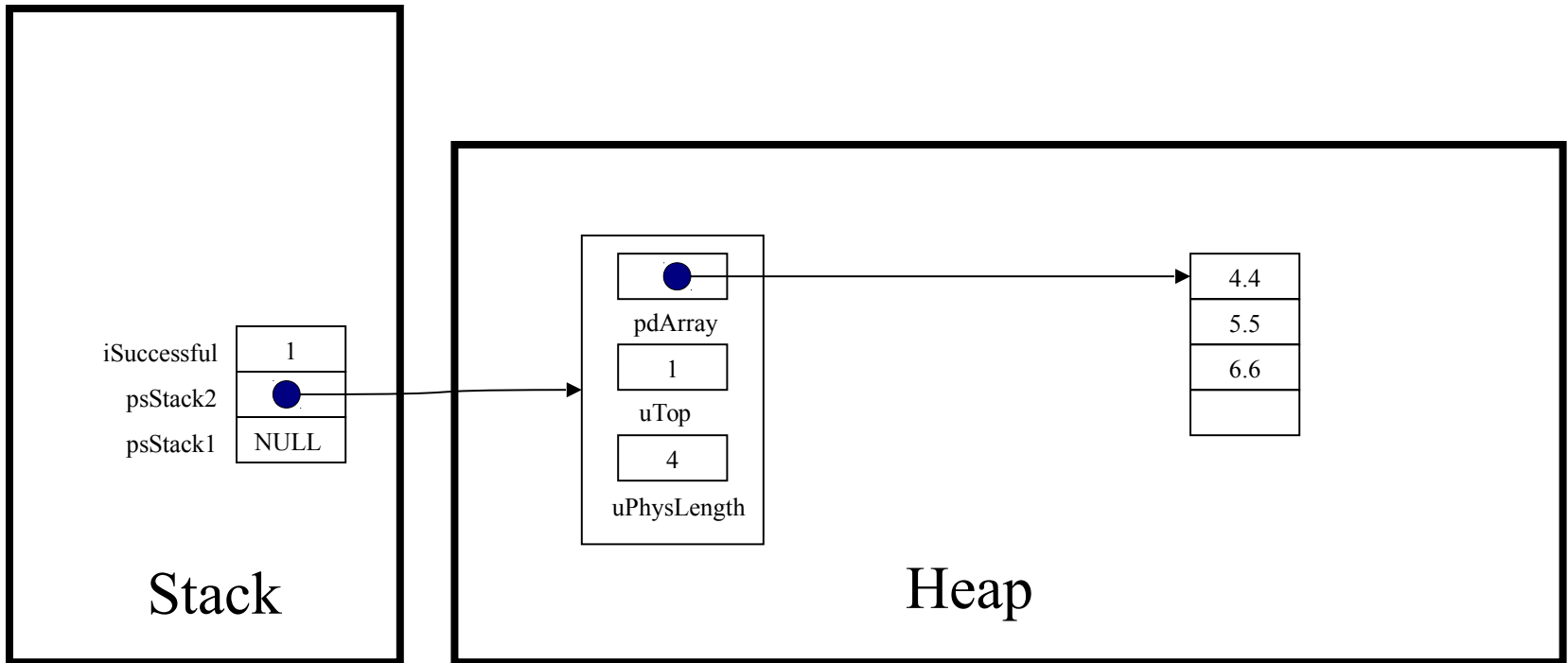

Princeton University
COS 217: Introduction to Programming Systems
Trace of teststack (Version 1)

```
printf("%g\n", Stack_pop(psStack2));
```

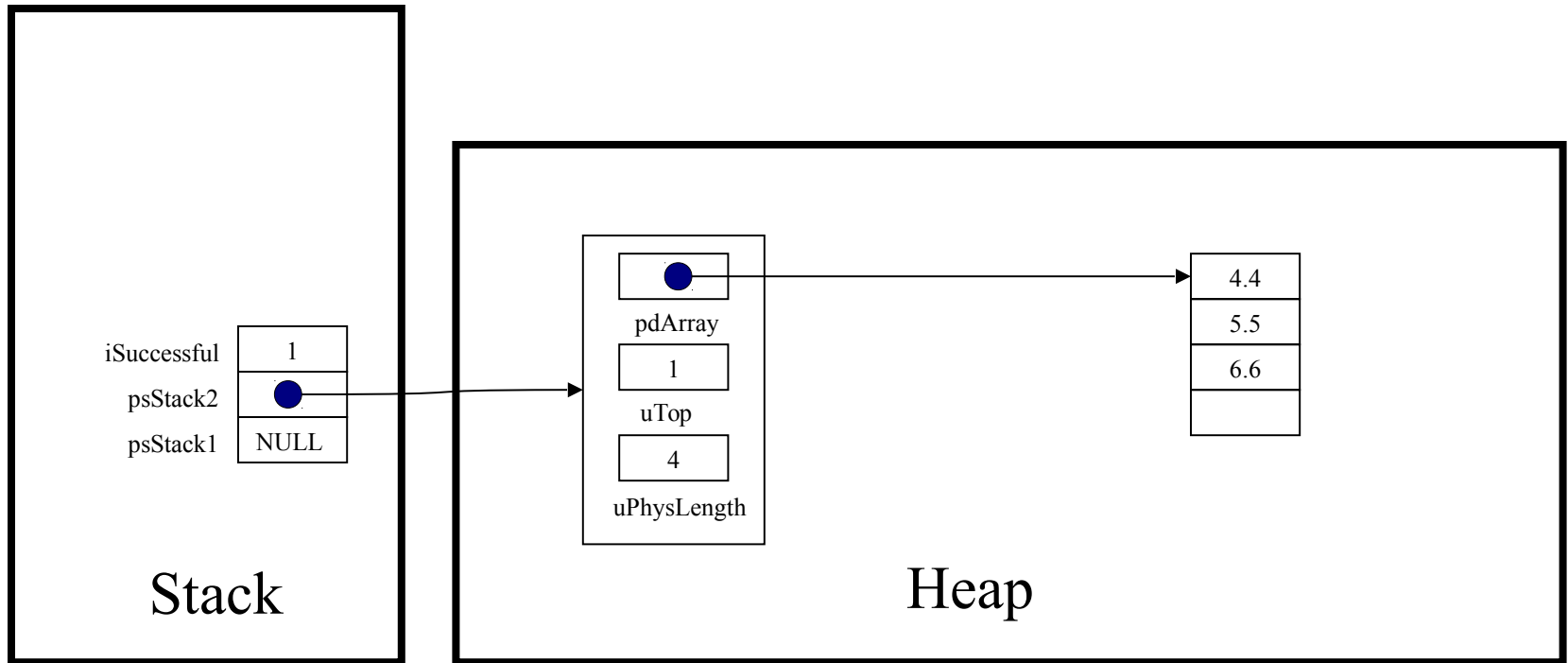

Princeton University
COS 217: Introduction to Programming Systems
Trace of teststack (Version 1)

```
while (! Stack_isEmpty(psStack2))  
    ...
```

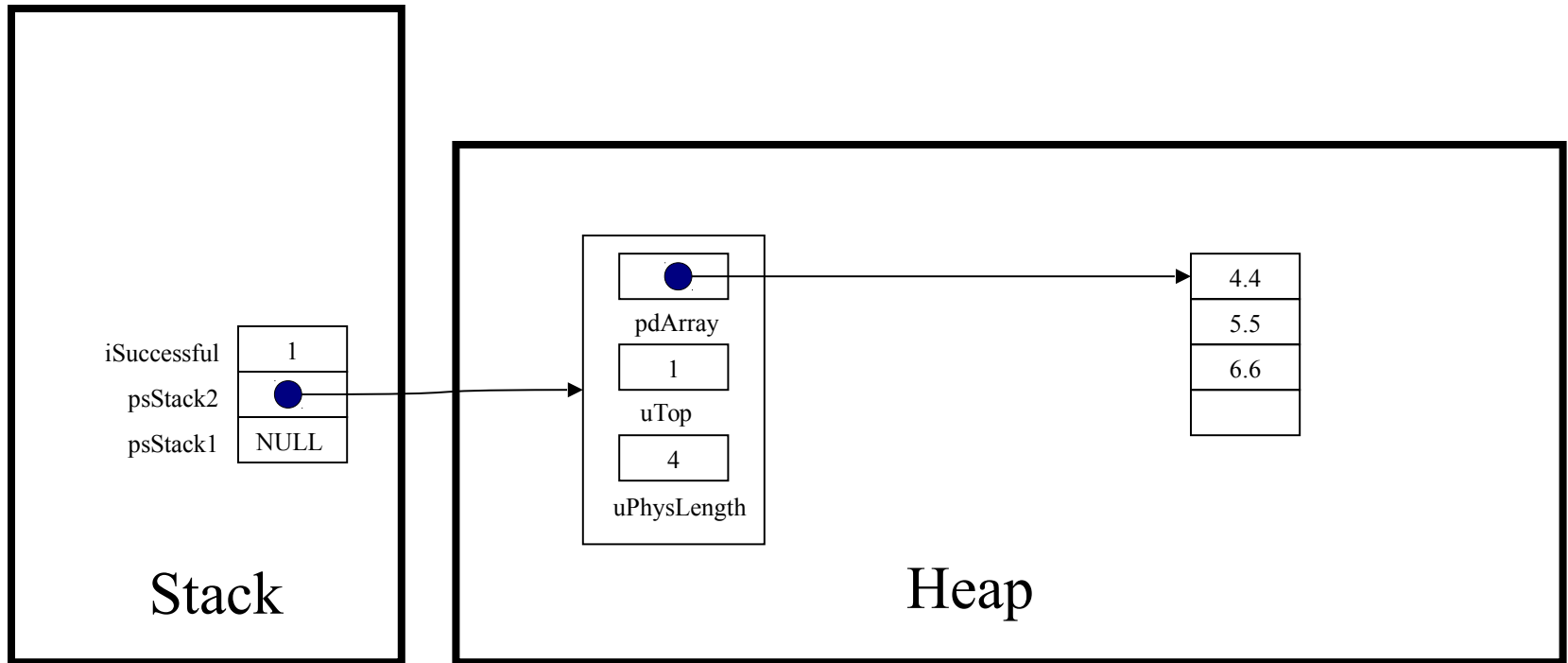

Princeton University
COS 217: Introduction to Programming Systems
Trace of teststack (Version 1)

```
int Stack_isEmpty(struct Stack *psStack)
```

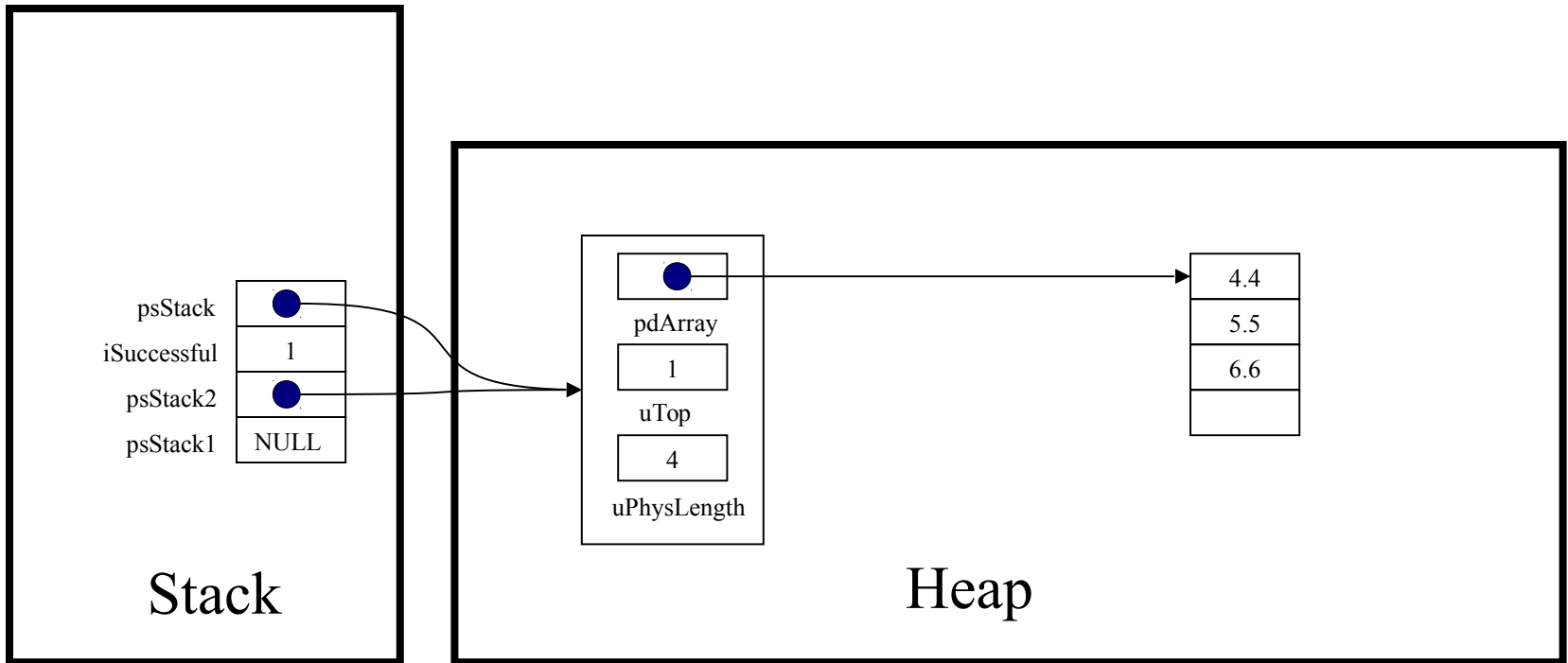

Princeton University
COS 217: Introduction to Programming Systems
Trace of teststack (Version 1)

```
assert (psStack != NULL);
```

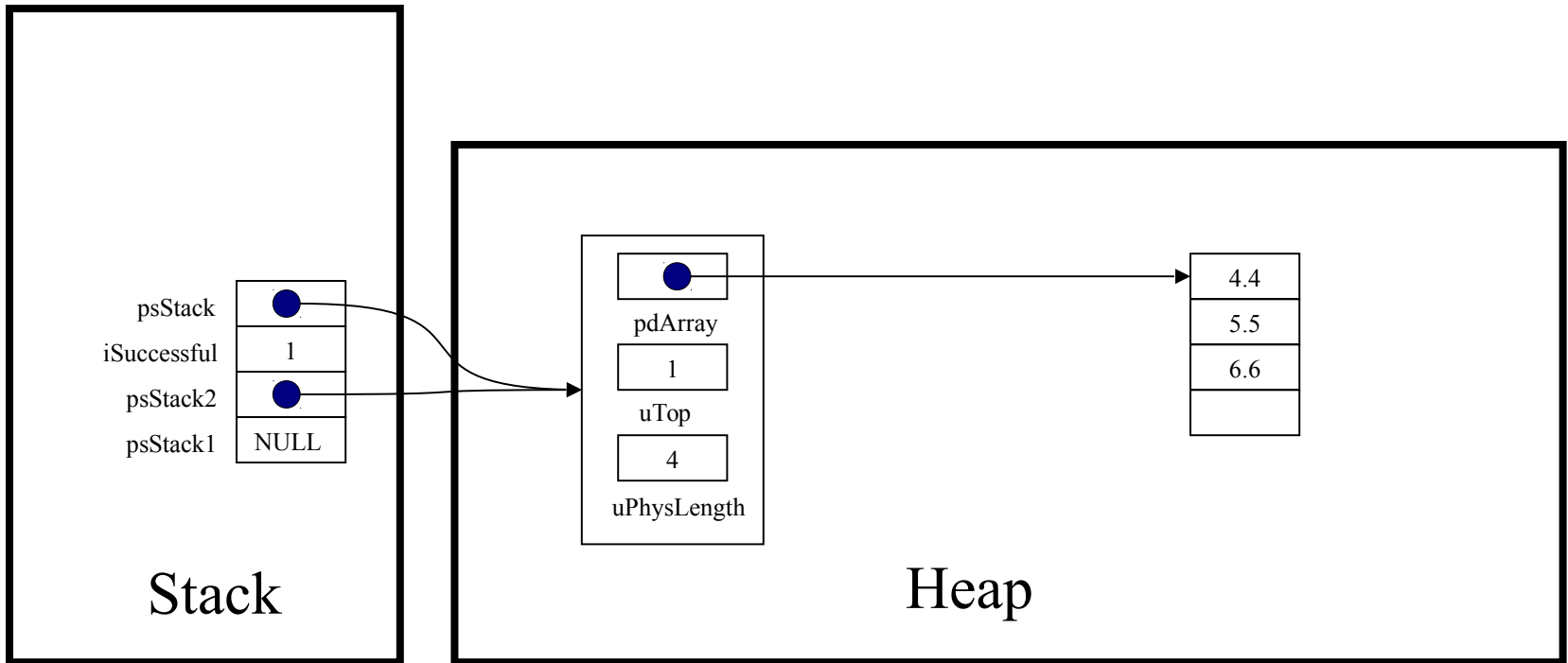

Princeton University
COS 217: Introduction to Programming Systems
Trace of teststack (Version 1)

```
return psStack->uTop == 0;
```

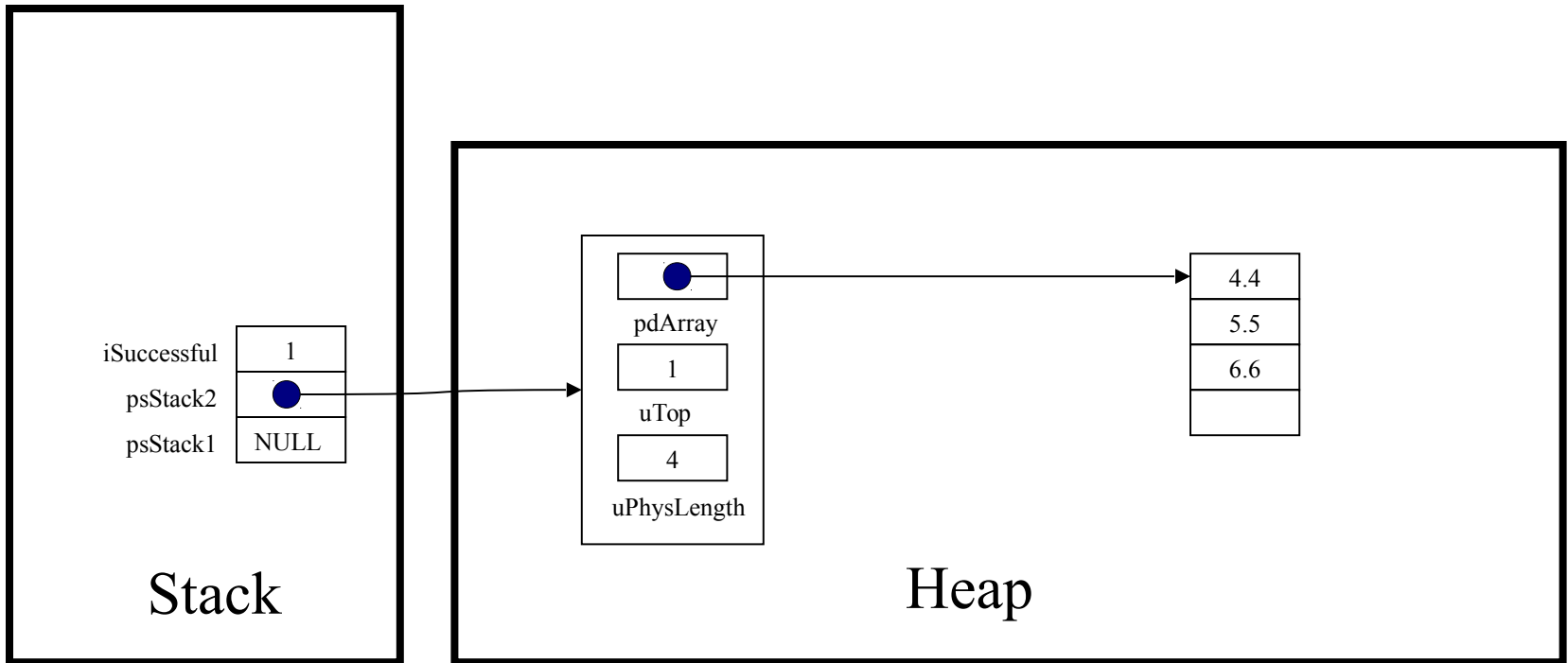

Princeton University
COS 217: Introduction to Programming Systems
Trace of teststack (Version 1)

```
while (! Stack_isEmpty(psStack2))
```

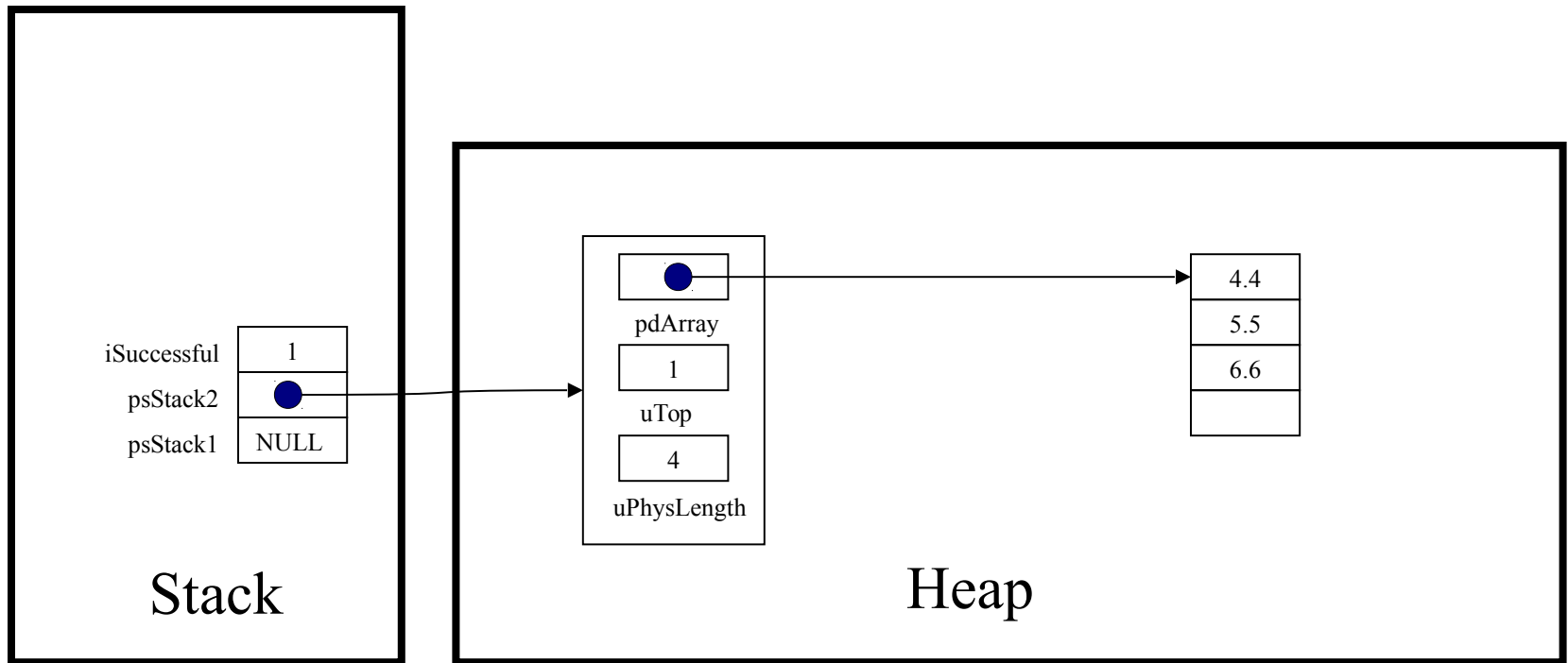

Princeton University
COS 217: Introduction to Programming Systems
Trace of teststack (Version 1)

```
printf("%g\n", Stack_pop(psStack2));
```

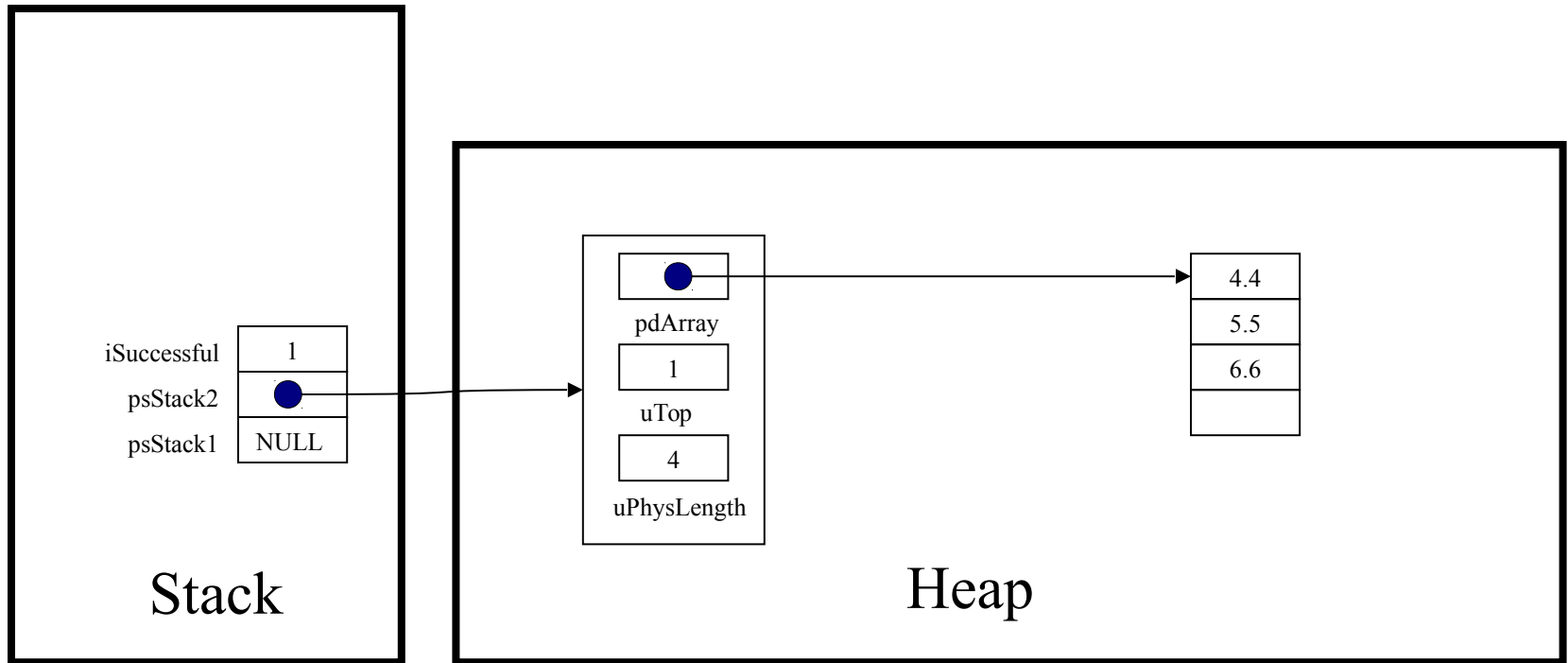

Princeton University
COS 217: Introduction to Programming Systems
Trace of teststack (Version 1)

```
double Stack_pop(struct Stack *psStack)
```

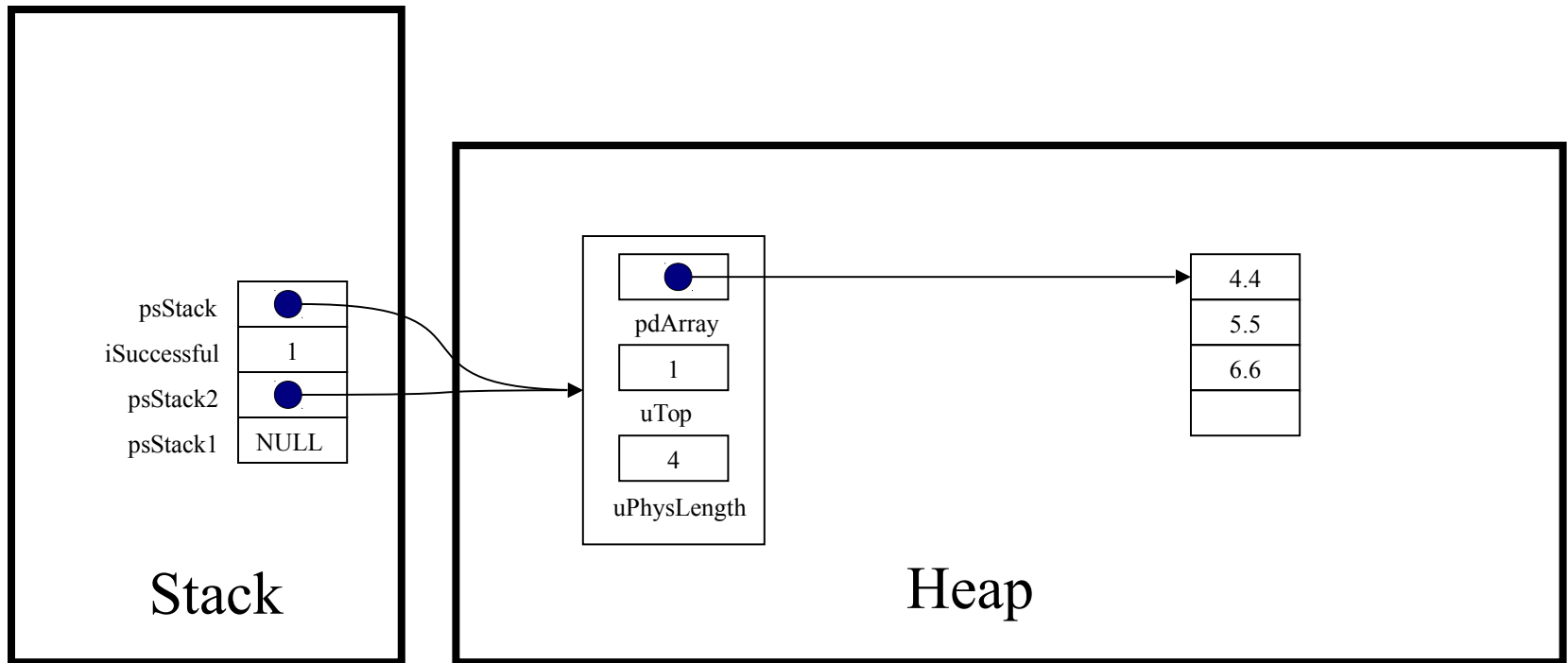

Princeton University
COS 217: Introduction to Programming Systems
Trace of teststack (Version 1)

```
assert (psStack != NULL);
```

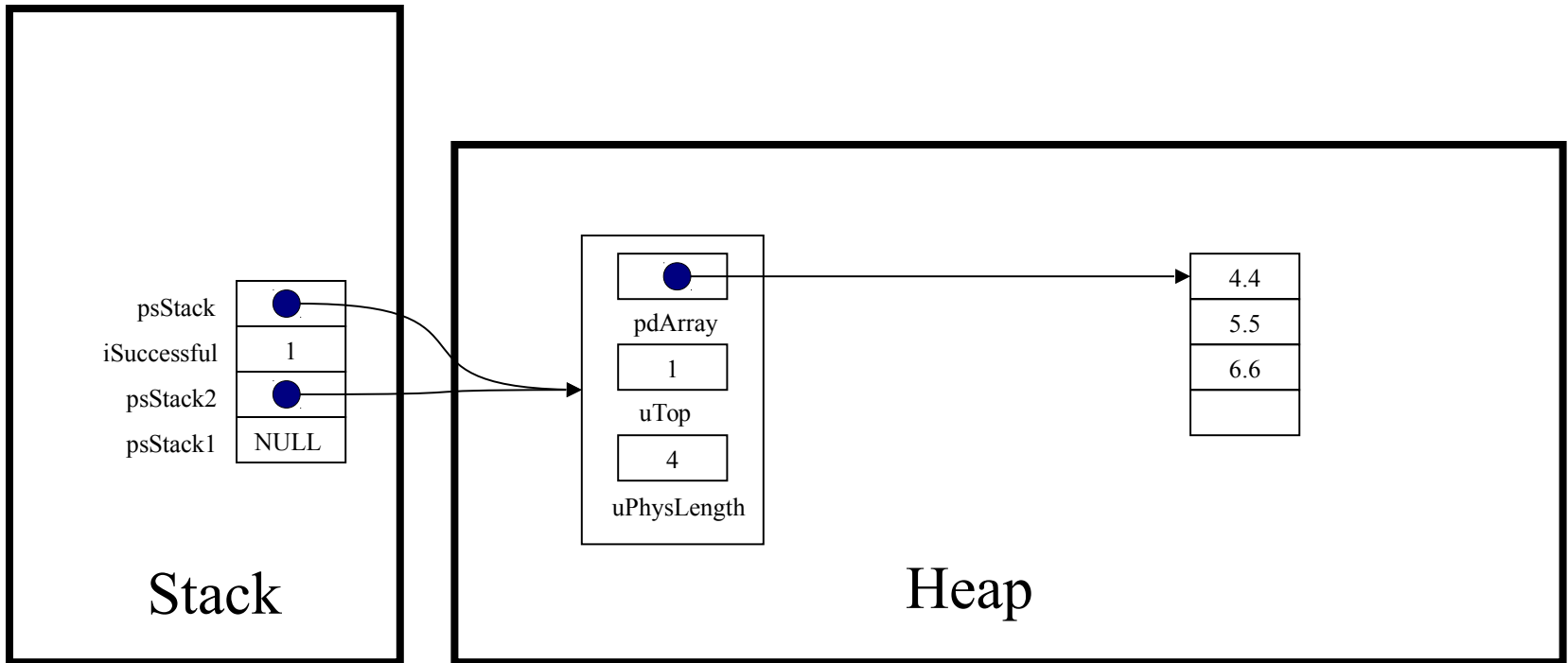

Princeton University
COS 217: Introduction to Programming Systems
Trace of teststack (Version 1)

```
assert (psStack->uTop > 0);
```

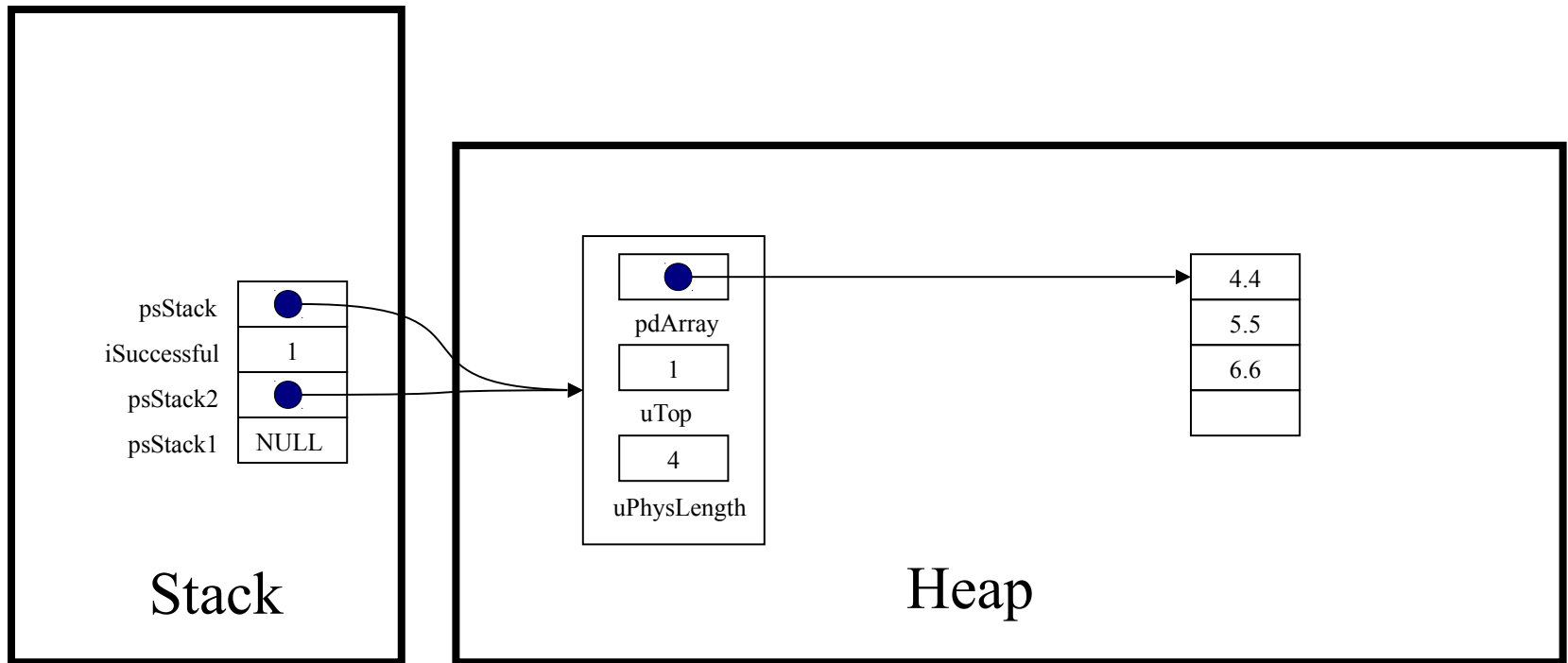

Princeton University
COS 217: Introduction to Programming Systems
Trace of teststack (Version 1)

```
(psStack->uTop) --;
```

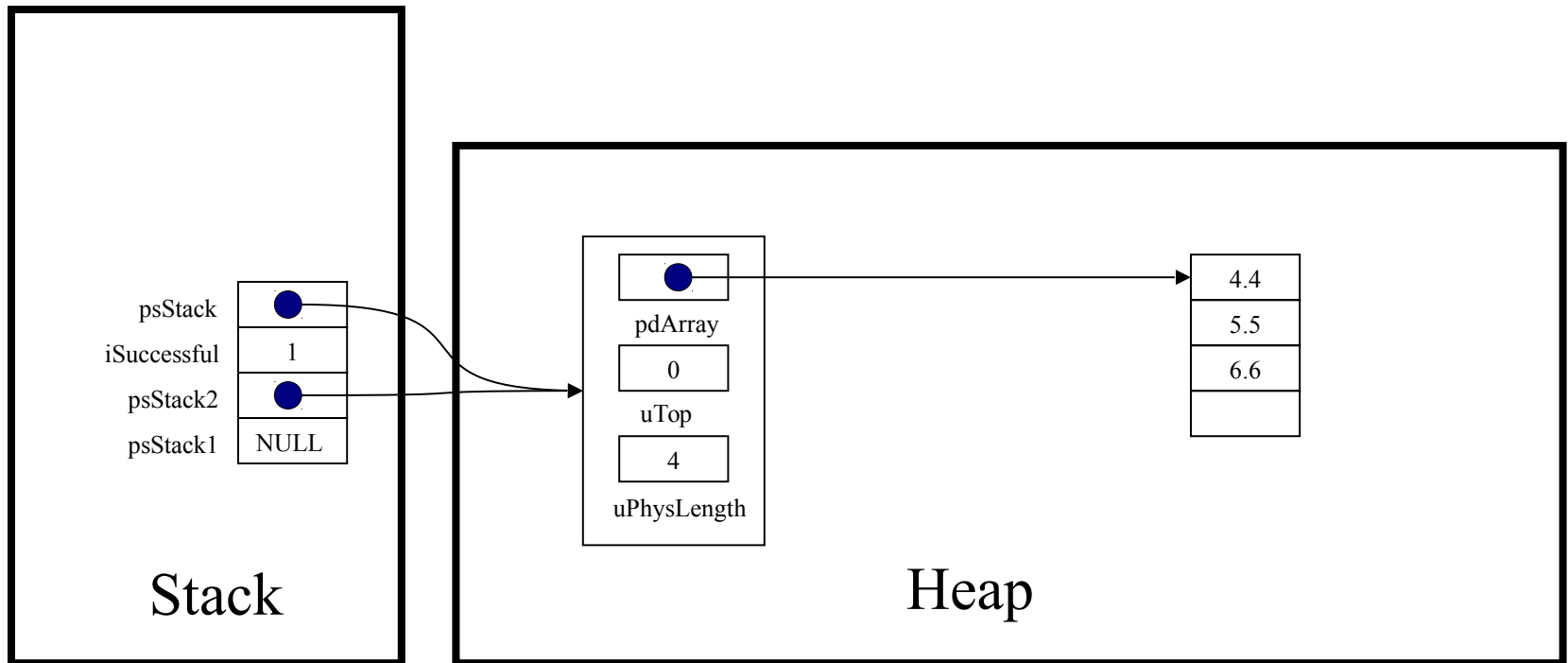

Princeton University
COS 217: Introduction to Programming Systems
Trace of teststack (Version 1)

```
return (psStack->pdArray)[psStack->uTop];
```

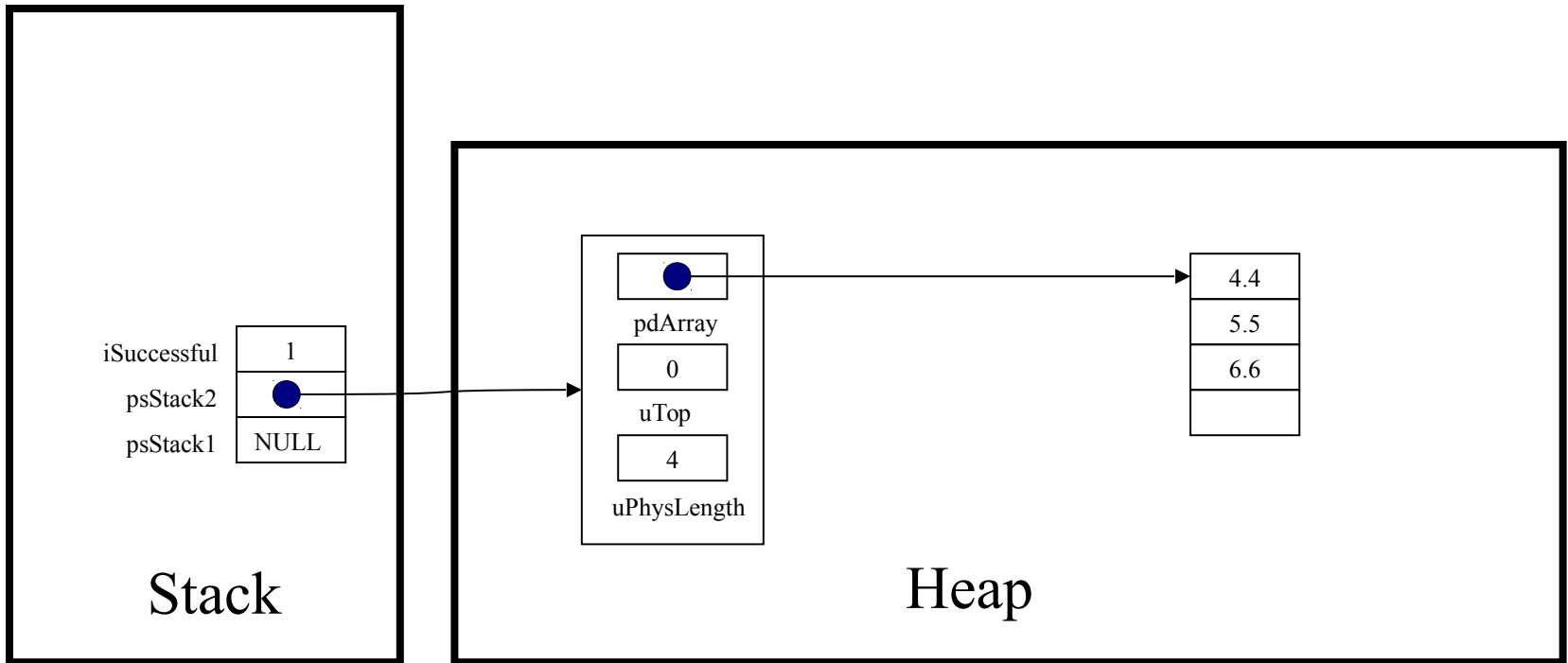

Princeton University
COS 217: Introduction to Programming Systems
Trace of teststack (Version 1)

```
printf("%g\n", Stack_pop(psStack2));
```

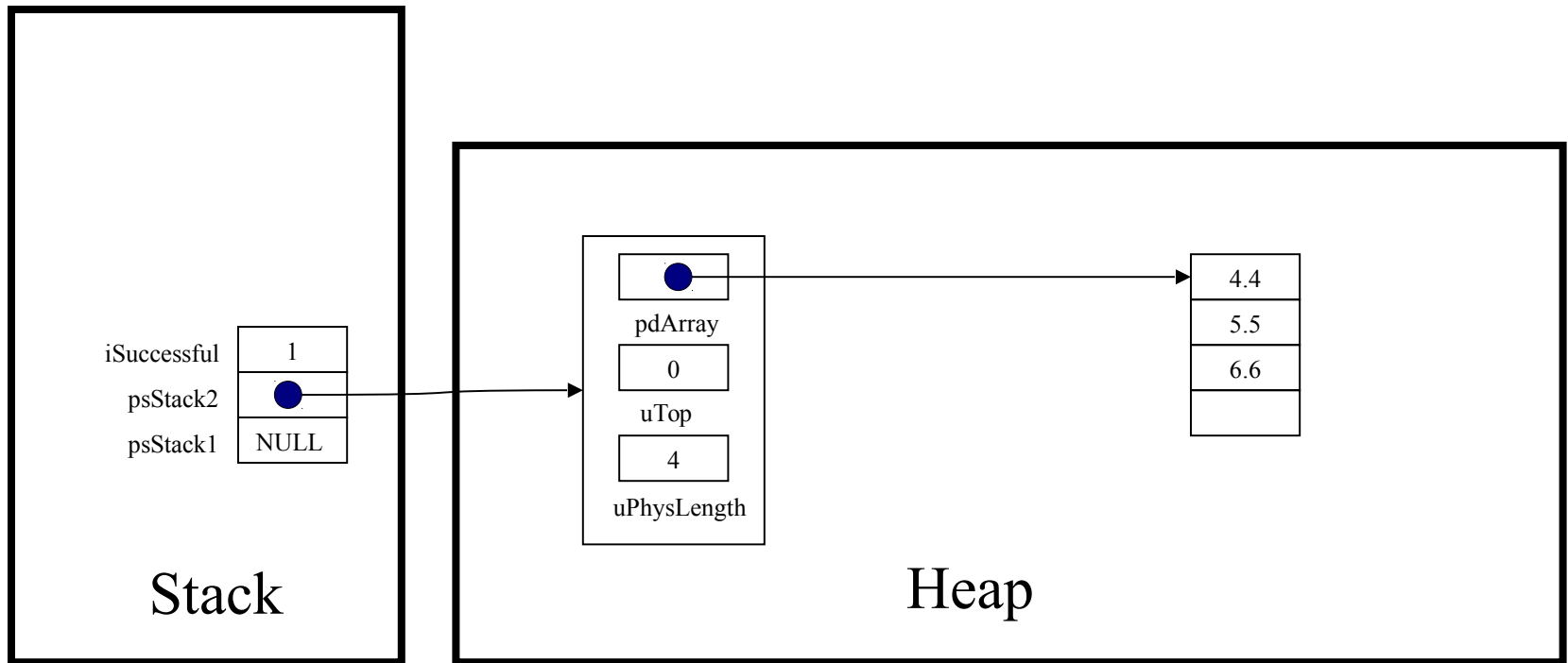

Princeton University
COS 217: Introduction to Programming Systems
Trace of teststack (Version 1)

```
while (! Stack_isEmpty(psStack2))  
    ...
```

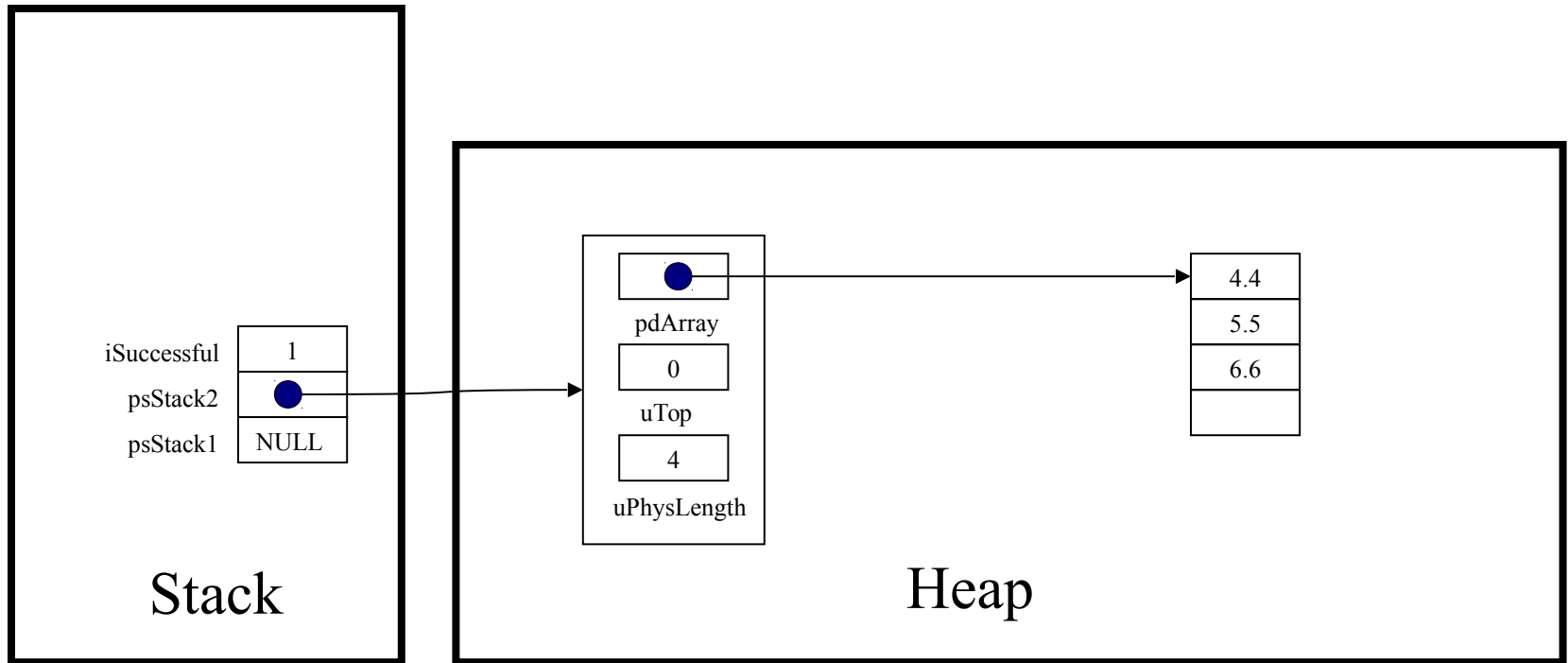

Princeton University
COS 217: Introduction to Programming Systems
Trace of teststack (Version 1)

```
int Stack_isEmpty(struct Stack *psStack)
```

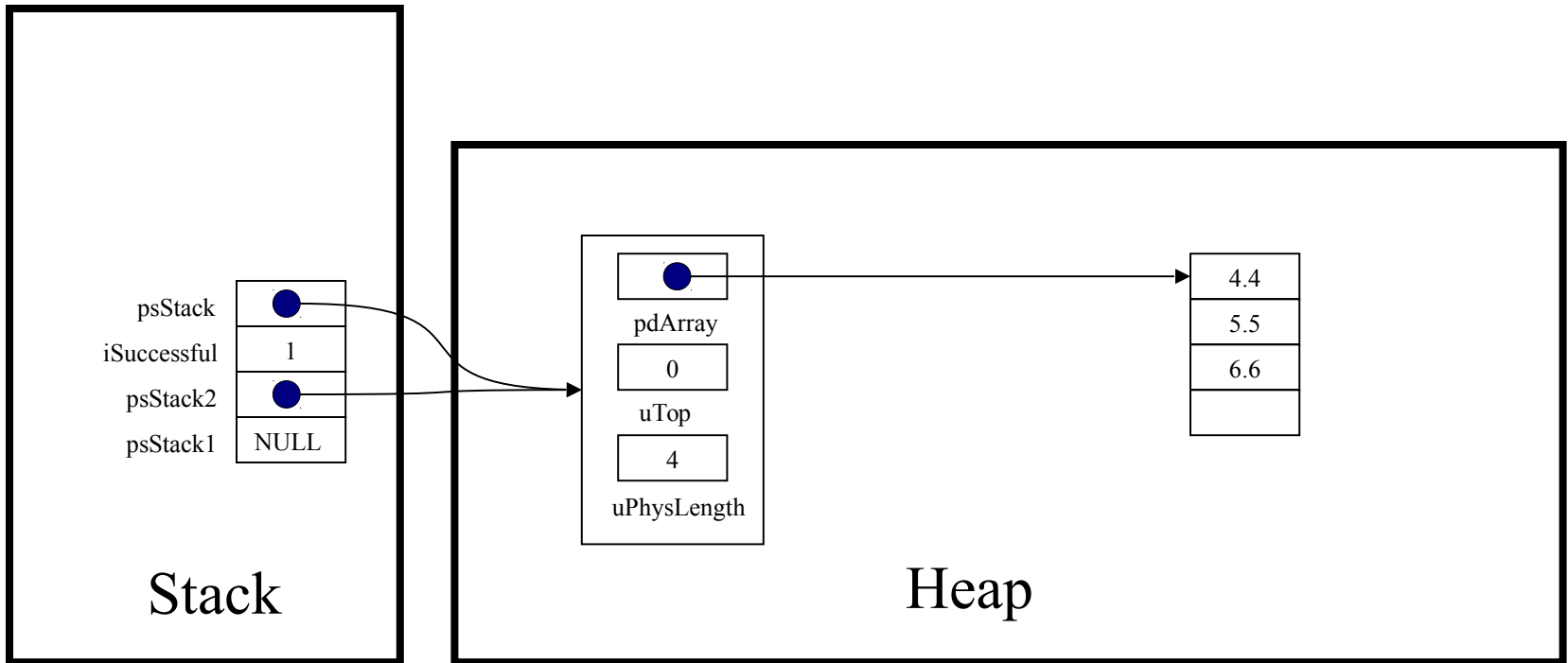

Princeton University
COS 217: Introduction to Programming Systems
Trace of teststack (Version 1)

```
assert (psStack != NULL);
```

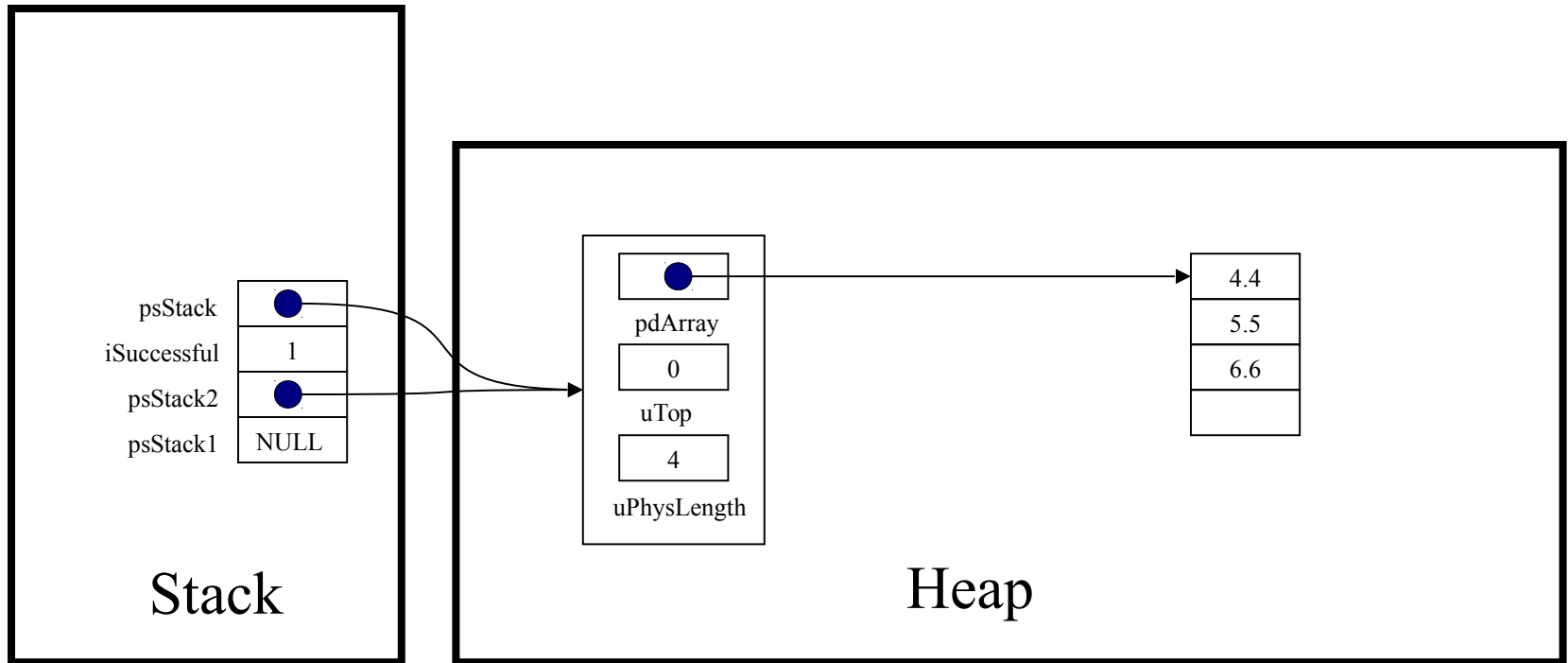

Princeton University
COS 217: Introduction to Programming Systems
Trace of teststack (Version 1)

```
return psStack->uTop == 0;
```

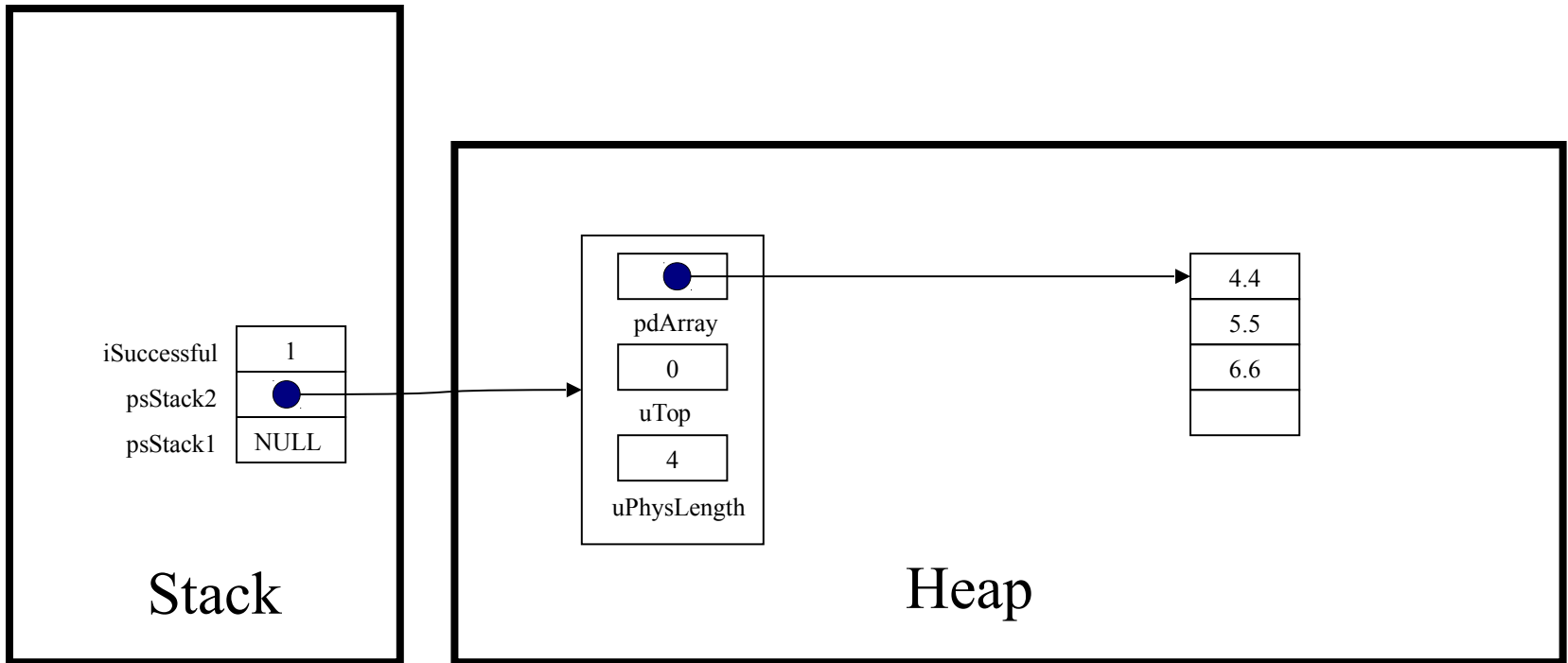

Princeton University
COS 217: Introduction to Programming Systems
Trace of teststack (Version 1)

```
while (! Stack_isEmpty(psStack2))
```

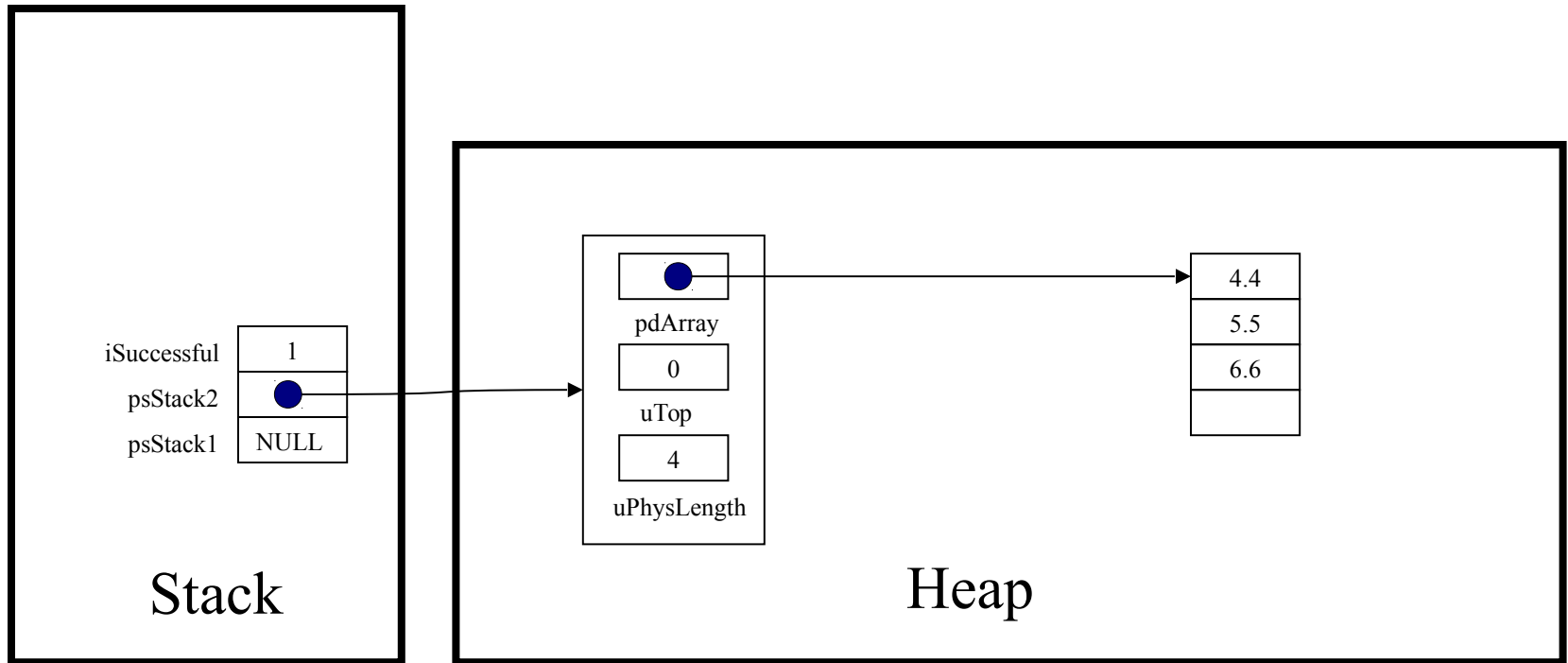

Princeton University
COS 217: Introduction to Programming Systems
Trace of teststack (Version 1)

```
Stack_free(psStack2);
```

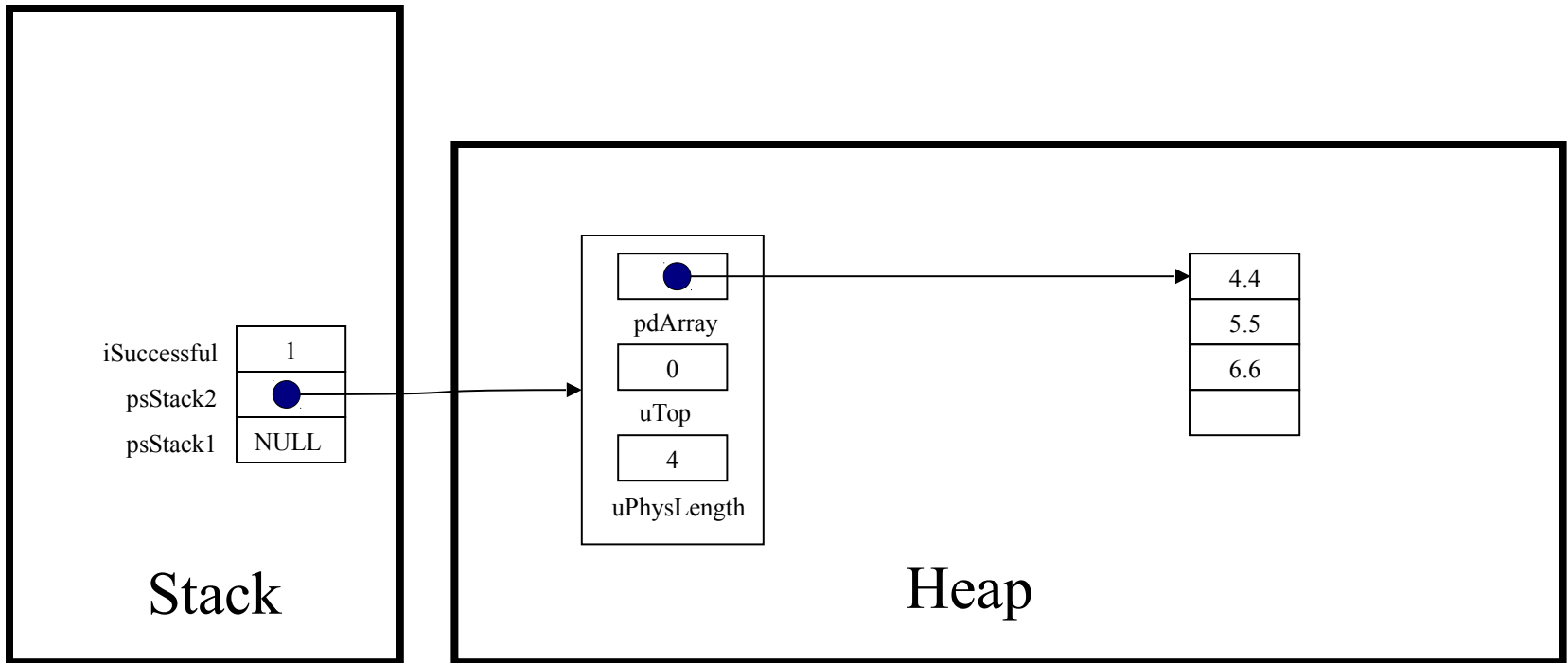

Princeton University
COS 217: Introduction to Programming Systems
Trace of teststack (Version 1)

```
void Stack_free(struct Stack *psStack)
```

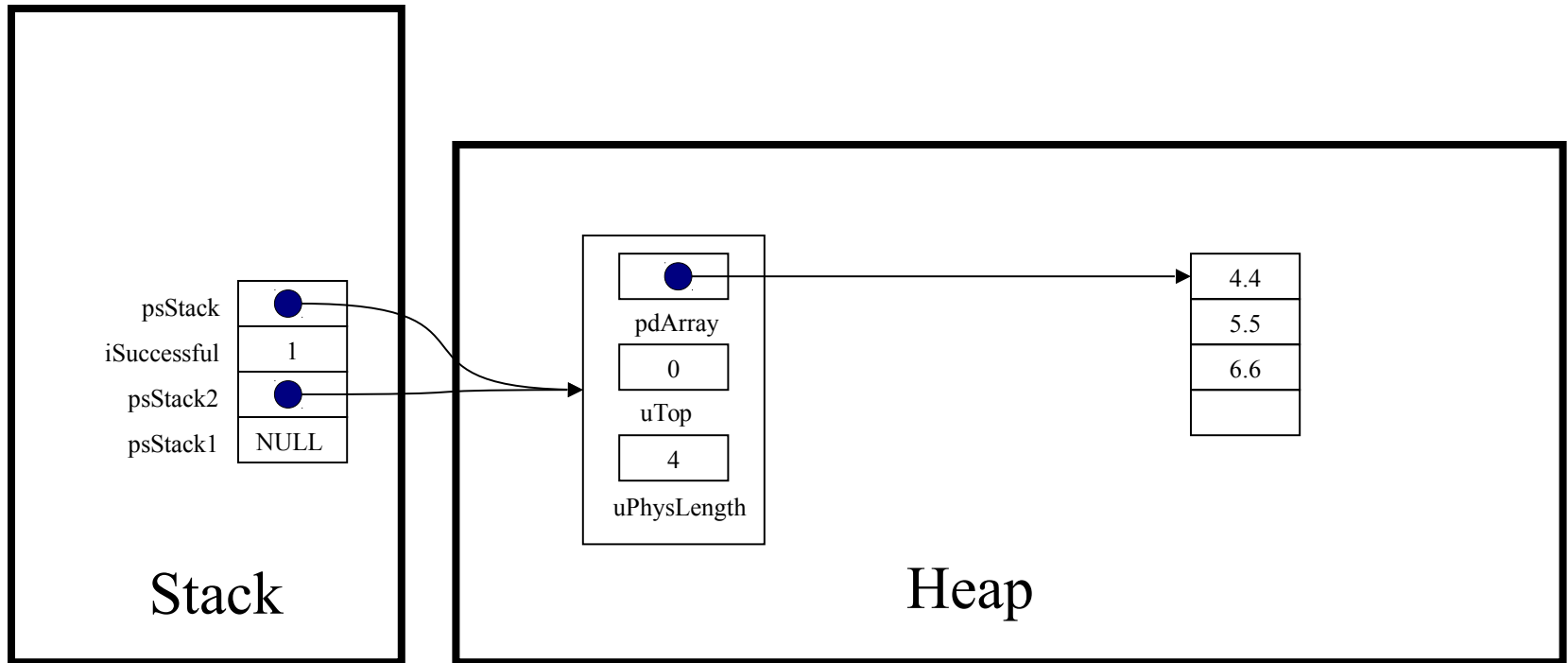

Princeton University
COS 217: Introduction to Programming Systems
Trace of teststack (Version 1)

```
assert (psStack != NULL);
```

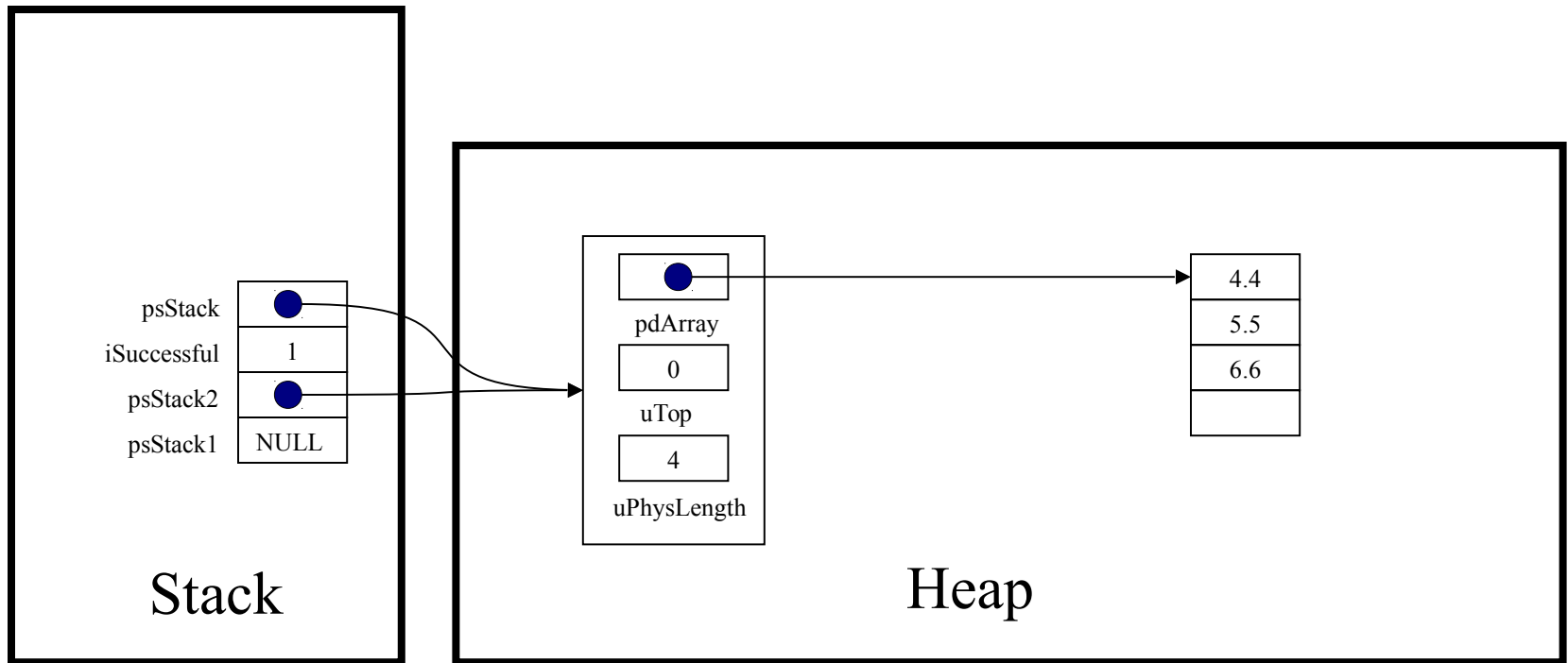

Princeton University
COS 217: Introduction to Programming Systems
Trace of teststack (Version 1)

```
free (psStack->pdArray);
```

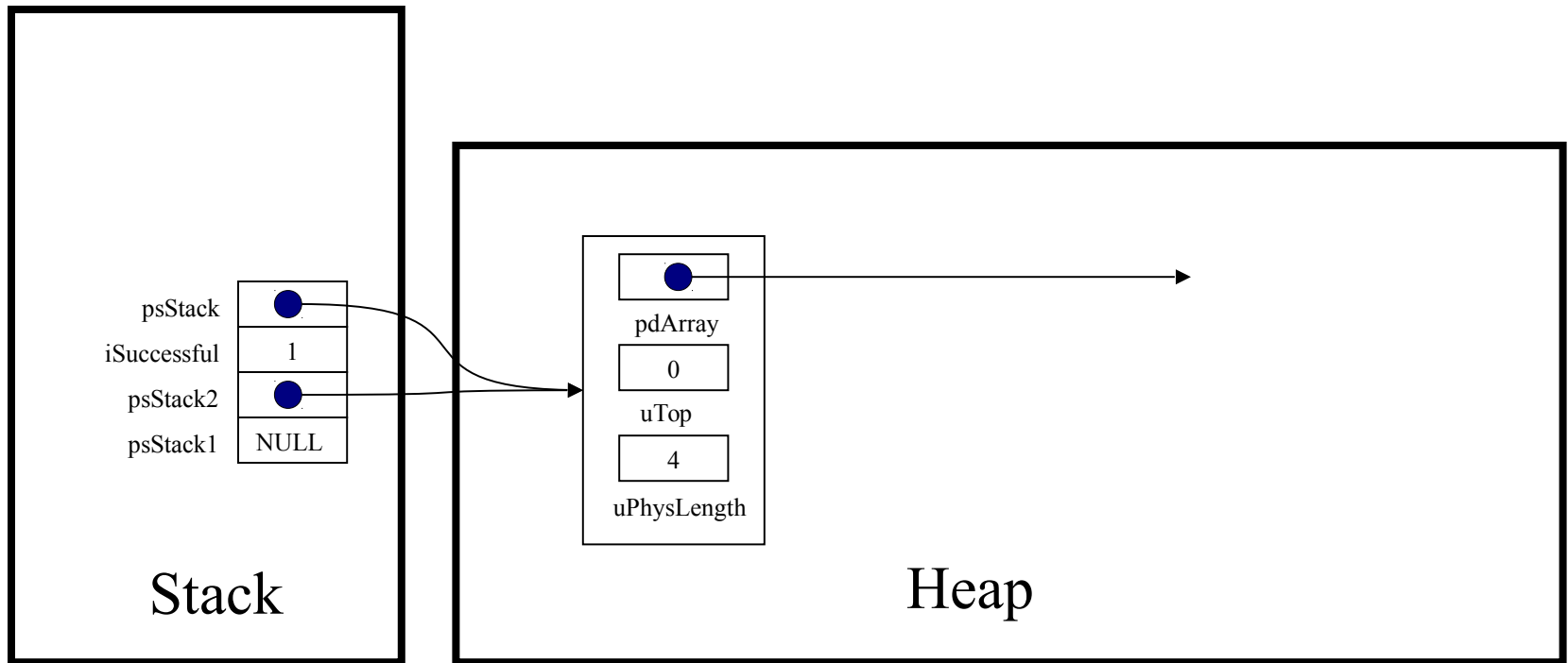

Princeton University
COS 217: Introduction to Programming Systems
Trace of teststack (Version 1)

```
free(psStack);
```

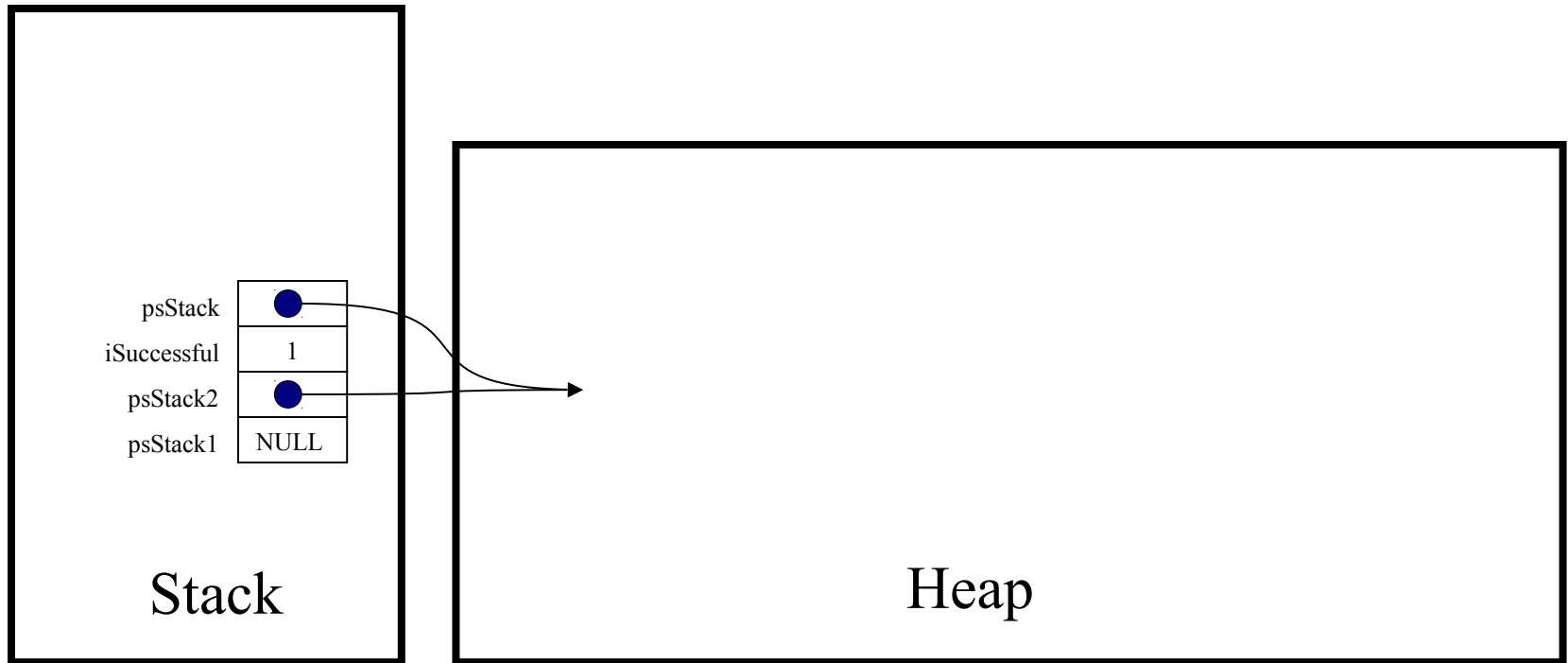

Princeton University
COS 217: Introduction to Programming Systems
Trace of teststack (Version 1)

Implicit return

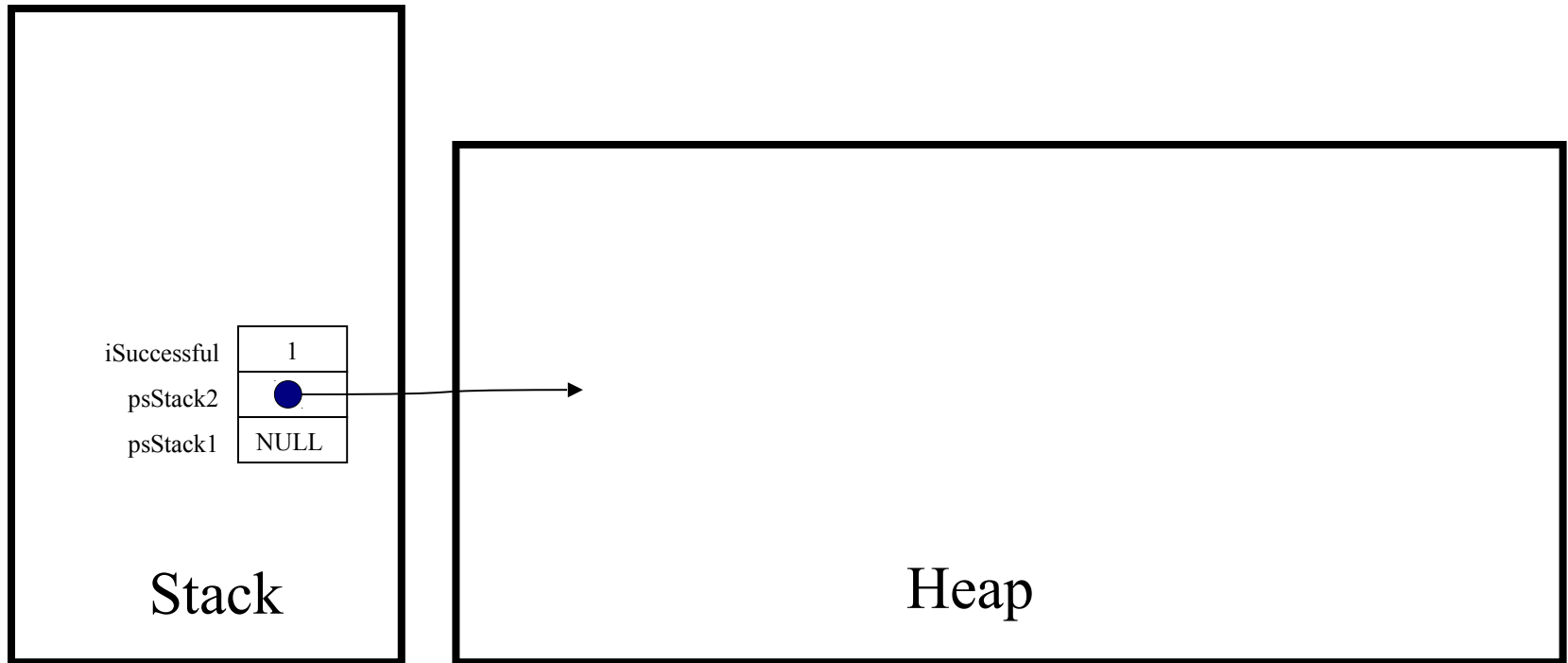

Princeton University
COS 217: Introduction to Programming Systems
Trace of teststack (Version 1)

```
psStack2 = NULL;
```

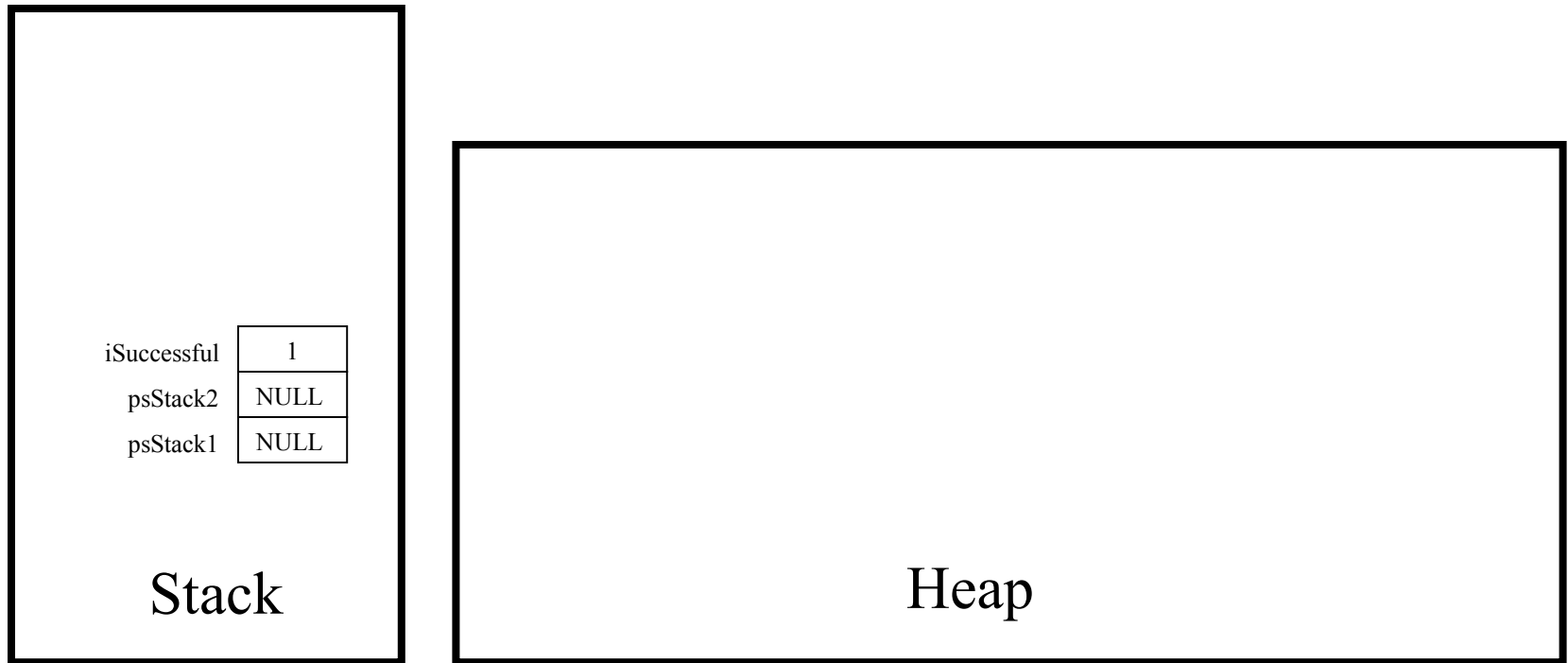

Princeton University
COS 217: Introduction to Programming Systems
Trace of teststack (Version 1)

```
return 0;
```

